



basic education
Department:
Basic Education
REPUBLIC OF SOUTH AFRICA

Candidate Barcode Label/Staffieskodeplakker

National Senior Certificate Answer Book
Nasionale Seniorsertifikaat-antwoordeboek

National Senior Certificate/*Nasionale Senior Sertifikaat* (Grade 12/*Graad 12*)

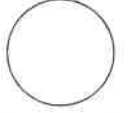

Sequence No. on mark sheet
Volgnommer op puntestaaf

CENTRE NUMBER
SENTRUMNUMMER

EXAMINATION NUMBER
EKSAMENNUMMER

DATE
DATUM

BOOK NUMBER
BOEKNOMMER

OF
VAN

BOOKS
BOEKE

SUBJECT CODE
VAKKODE

PAPER NUMBER
VRAESTELNUMMER

2

SUBJECT NAME
VAKNAAM

MATHEMATICS/WISKUNDE

MARKER/NASIENER			MODERATOR'S INITIALS IN RELEVANT BLOCK MODERATOR SE VOORLETTERS IN RELEVANTE BLOKKIE									
Question Vraag	Marks Punte	Marker's Code & Initials Nasiener se Kode & Voorletters	Marks Punte	SM	Marks Punte	DCM AHN	Marks Punte	CM HN	Marks Punte	IM	Marks Punte	EM
1												
2												
3												
4												
5												
6												
7												
8												
9												
10												
11												
TOTAL TOTAAL												

CONTROLLED AND CERTIFIED CORRECT
(SURNAME AND INITIALS OF EA)
GEKONTROLEER EN AS KORREK
GESERTIFISEER
(VAN EN VOORLETTERS VAN EA)

READ INSTRUCTIONS ON NEXT PAGE.
LEES INSTRUKSIES OP VOLGENDE BLADSY.

This answer book consists of 27 pages./Hierdie antwoordeboek bestaan uit 27 bladsye.

FOLLOW THESE INSTRUCTIONS CAREFULLY	VOLG HIERDIE INSTRUKSIES NOUKEURIG
1. Clearly write your examination number and centre number in the spaces provided and attach your barcode label in the space provided.	1. Skryf jou eksamennommer en sentrumnommer duidelik in die ruimtes soos verskaf en plak jou stafieskodeplakker in die ruimte soos verskaf.
2. Remember that your own name (or the name of your school) may not appear anywhere on or in this answer book.	2. Onthou dat jou eie naam (of die naam van jou skool) nie op of in hierdie antwoordeboek mag voorkom nie.
3. No pages may be torn from this answer book.	3. Geen bladsye mag uit hierdie antwoordeboek geskeur word nie.
4. Read the instructions printed on your timetable carefully as well as any other instructions which may be given in each examination paper.	4. Lees die instruksies wat op jou eksamenrooster gedruk is, sorgvuldig deur, asook enige ander instruksies wat in elke eksamenvraestel gegee word.
5. Candidates may not retain any answer book or remove them from the examination room.	5. Geen antwoordeboek mag deur die kandidaat behou of uit die eksamenlokaal verwyder word nie.
6. Answers must be written in black/blue ink as distinctly as possible.	6. Skryf die antwoorde so duidelik moontlik met swart/blou.
7. Draw a neat line through any work/rough work that must not be marked.	7. Trek 'n netjiese lyn deur enige werk/rofwerk wat nie nagesien moet word nie.

QUESTION/VRAAG 1

DAYS/DAE	1	2	3	4	5	6	7	8	9	10
UNITS OF BLOOD EENHEDE BLOED	45	59	65	73	79	82	91	99	101	106

	Solution/Oplissing	Marks Punte
1.1.1	<hr/> <hr/> <hr/> <hr/> <hr/> <hr/> <hr/> <hr/>	(2)
1.1.2	<hr/> <hr/> <hr/> <hr/> <hr/> <hr/> <hr/> <hr/>	(2)
1.1.3	<hr/> <hr/> <hr/> <hr/> <hr/> <hr/> <hr/> <hr/>	(3)
1.2.1	<hr/> <hr/> <hr/> <hr/>	(1)

	Solution/<i>Oplossing</i>	Marks <i>Punte</i>
1.2.2		(2)
1.3		(1)
		[11]

QUESTION/VRAAG 2

NUMBER OF HOURS GETAL URE	30	50	80	100	120	150	190	220	260
VALUE OF SALES (IN THOUSANDS OF RANDB) WAARDE VAN VERKOPE (IN DUISEND RAND)	270	275	376	100	420	602	684	800	820

	Solution/Oplissing	Marks Punte
2.1		(1)
2.2		(3)
2.3		(2)
2.4		(2)
		[8]

QUESTION/VRAAG 3

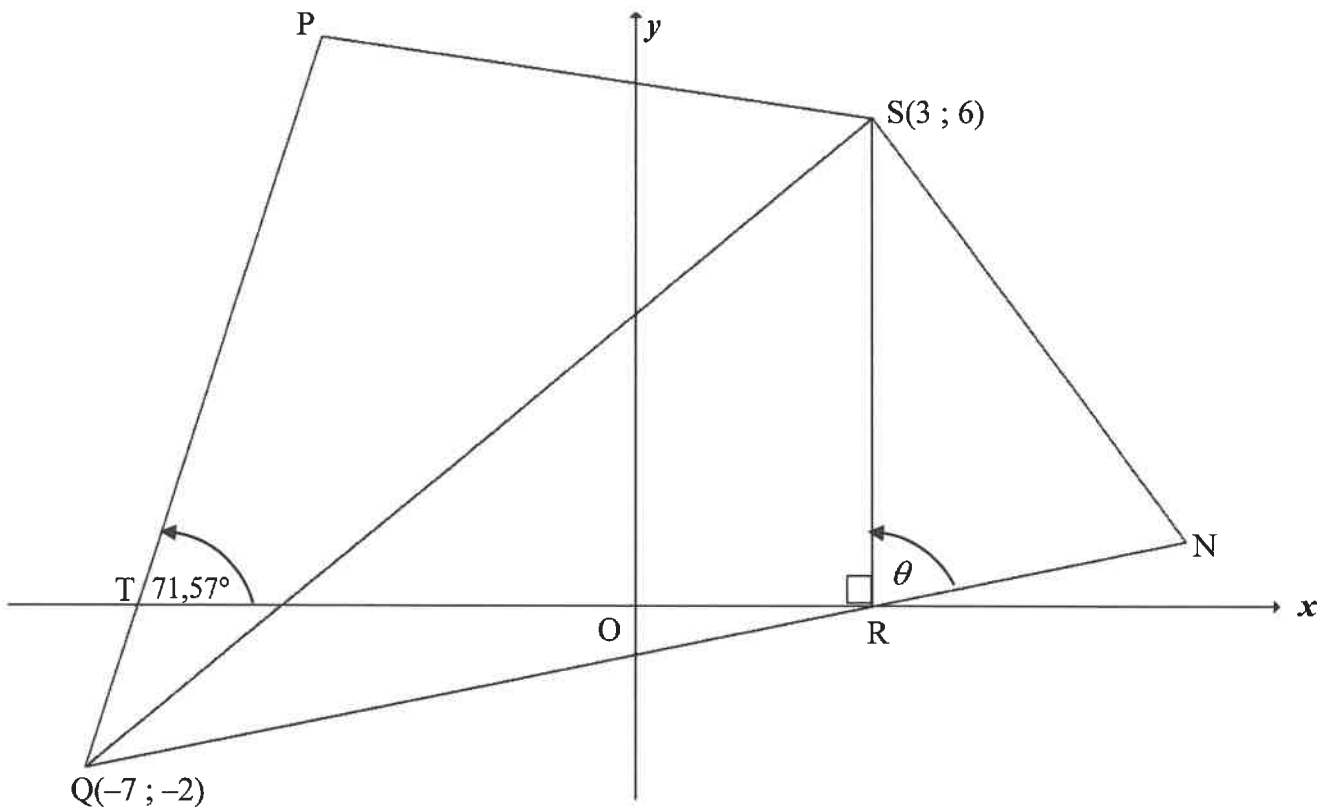

	Solution/Oplissing	Marks Punte
3.1		(1)
3.2		(2)
3.3		(2)

	Solution/Oplossing	Marks Punte
3.4	<hr/> <hr/> <hr/> <hr/> <hr/> <hr/> <hr/> <hr/>	(2)
3.5	<hr/> <hr/> <hr/> <hr/> <hr/> <hr/> <hr/> <hr/>	(3)
3.6	<hr/> <hr/> <hr/> <hr/> <hr/> <hr/> <hr/> <hr/> <hr/> <hr/> <hr/> <hr/> <hr/> <hr/> <hr/> <hr/> <hr/> <hr/> <hr/> <hr/> <hr/> <hr/> <hr/> <hr/>	(6)
		[16]

QUESTION/VRAAG 4

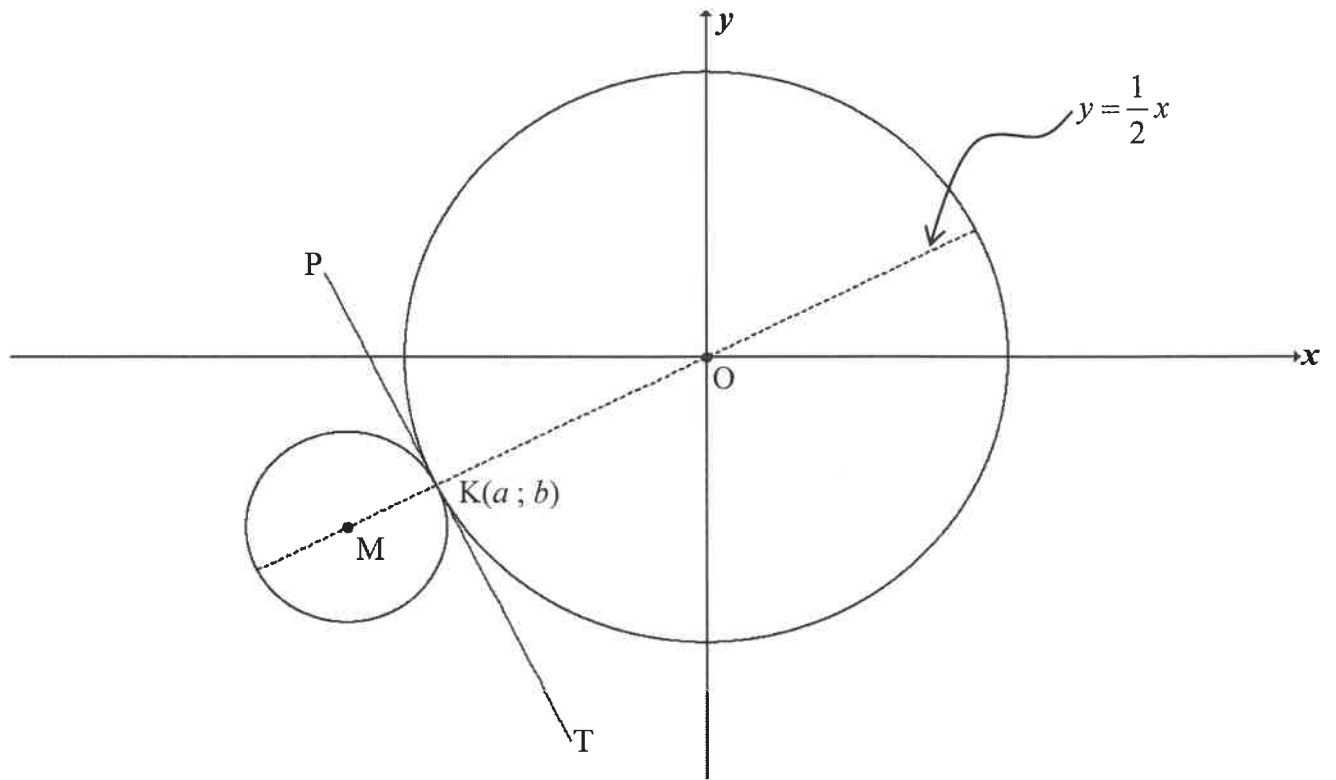

	Solution/Oplissing	Marks Punte
4.1		(1)
4.2		
		(4)

	Solution/<i>Oplossing</i>	Marks <i>Punte</i>
4.3.1		
4.3.2		(3)
4.3.3		(2)

	Solution/Oplossing	Marks Punte
4.4		(3)
4.5		(5)
		[24]

QUESTION/VRAAG 5

	Solution/Oplissing	Marks Punte	
5.1.1		(4)	
5.1.2		(3)	
5.2		(6)	

	Solution/Oplossing	Marks Punte
5.3		(2)
5.4.1		(3)
5.4.2		(5)

	Solution/Oplossing	Marks Punte
5.4.3		
		(4)
5.5.1		
		(1)
5.5.2		
		(2)
5.5.3		
		(3)
		[33]

QUESTION/VRAAG 6

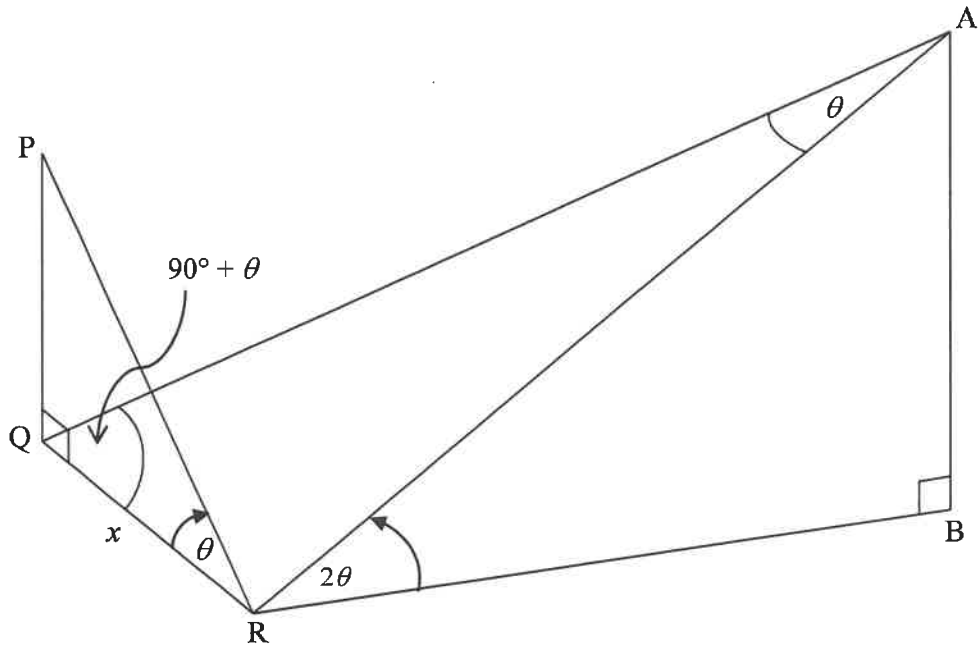

	Solution/Oplissing	Marks Punte
6.1.1		(2)
6.1.2		(2)

6.2		
	(4)	
6.3		
	(2)	
	[10]	

Give reasons for your statements in QUESTIONS 7, 8, 9 and 10.
 Gee redes vir jou bewerings in VRAAG 7, 8, 9 en 10.

QUESTION/VRAAG 7

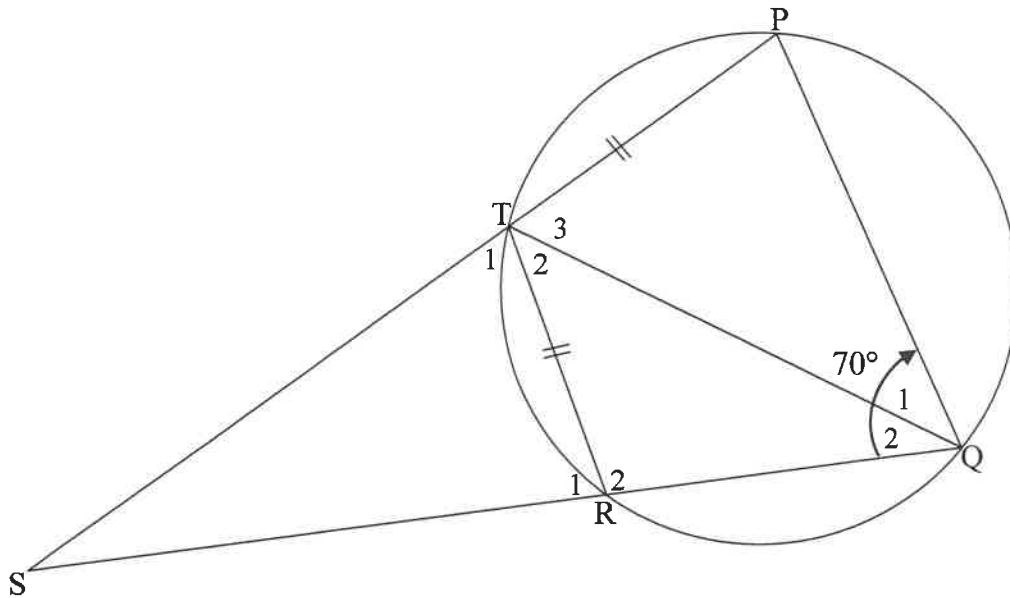

	Solution/Oplissing	Marks Punte
7.1.1		(2)
7.1.2		(2)

	Solution/<i>Oplossing</i>	Marks <i>Punte</i>
7.2.1		
7.2.2		
		[8]

QUESTION/VRAAG 9

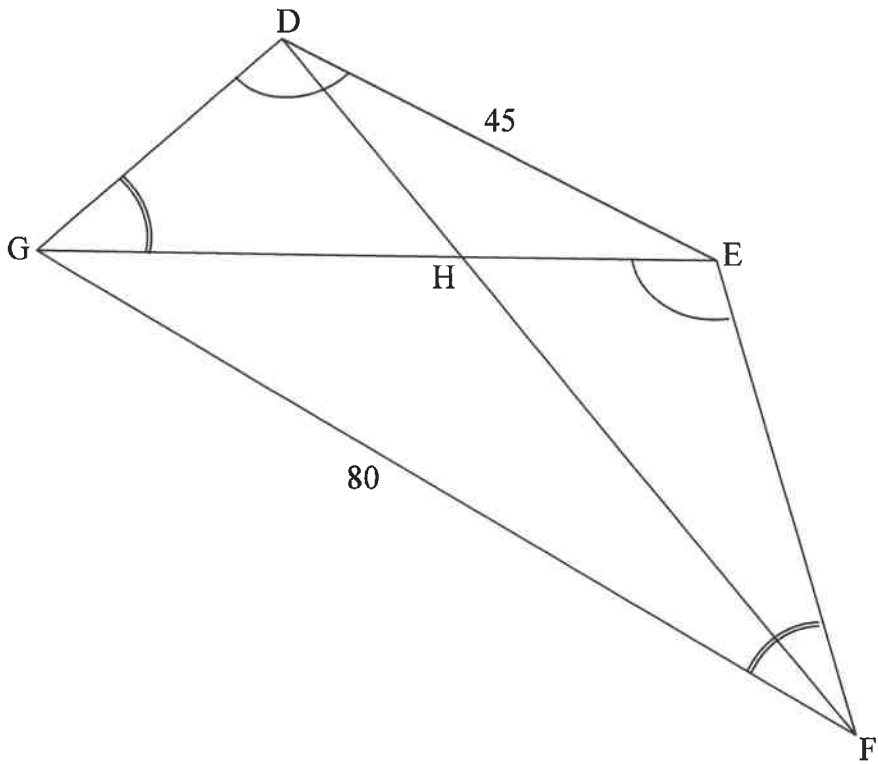

	Solution/Oplissing	Marks Punte
9.1		(1)
9.2		(3)

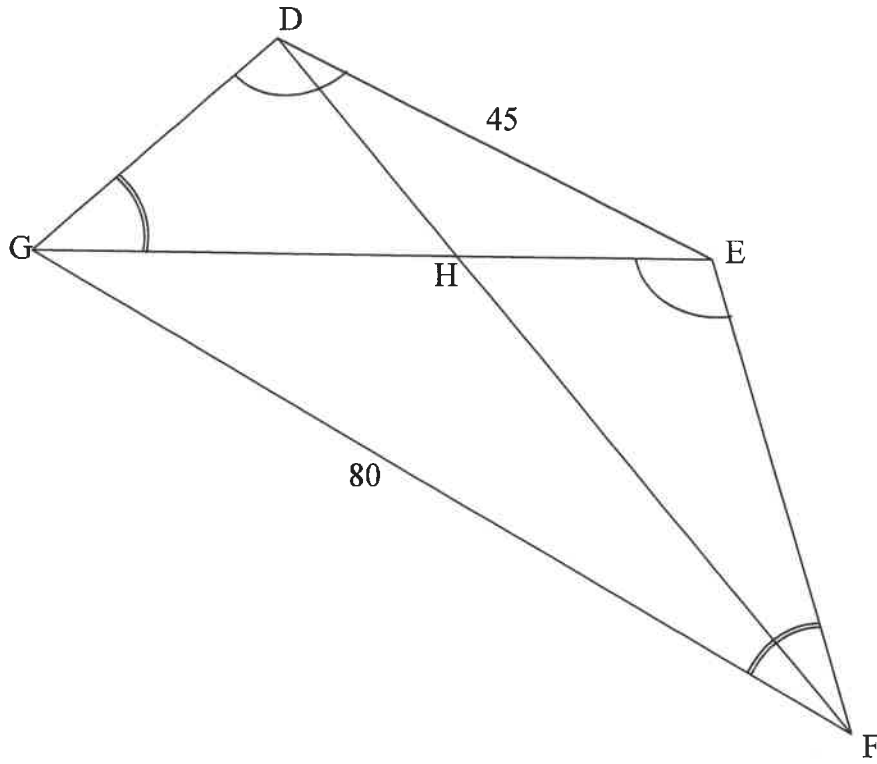

	Solution/Oplossing	Marks Punte
9.3		
		(3)
9.4		
		(3)
		[10]

10.2

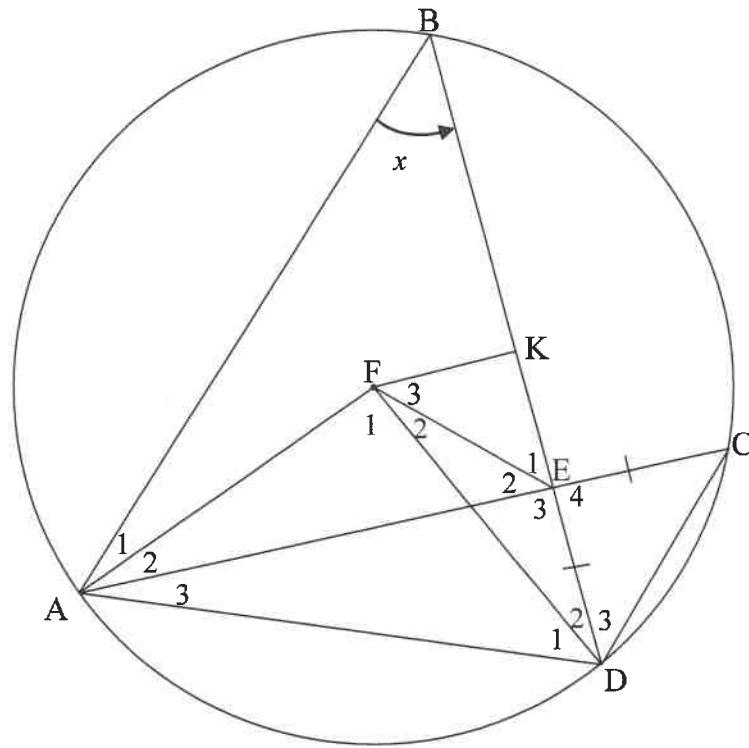

	Solution/Oplissing	Marks Punte
10.2.1(a)		(2)
10.2.1(b)		(2)

	Solution/Oplossing	Marks Punte
10.2.2		(4)
10.2.3		(6)
10.2.4		(5)
		[24]

