



Mind the Gap!

Mathematical Literacy Study Guide

Grade
12



basic education

Department:
Basic Education
REPUBLIC OF SOUTH AFRICA

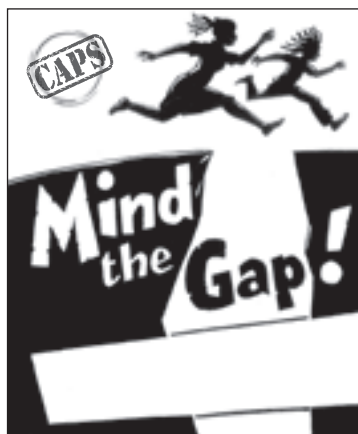

This content may not be sold or used for commercial purposes.

Curriculum and Assessment Policy Statement (CAPS) Grade 12

Mind the Gap study guide for Mathematical Literacy

ISBN 978-1-4315-1936-1

This publication has a **Creative Commons Attribution NonCommercial Sharealike license**. You can use, modify, upload, download, and share content, but you must acknowledge the Department of Basic Education, the authors and contributors. If you make any changes to the content you must send the changes to the Department of Basic Education. This content may not be sold or used for commercial purposes. For more information about the terms of the license please see:

<http://creativecommons.org/licenses/by-nc-sa/3.0/>.

Copyright © Department of Basic Education 2015

222 Struben Street, Pretoria, South Africa

Contact person: Dr Patricia Watson

Email: watson.p@dbe.gov.za

Tel: (012) 357 4502

<http://www.education.gov.za>

Call Centre: 0800202933

The first edition, published in 2012, for the Revised National Curriculum Statement (RNCS) Grade 12 Mind the Gap study guides for Accounting, Economics, Geography and Life Sciences; the second edition, published in 2014, aligned these titles to the Curriculum and Assessment Policy Statement (CAPS) and added more titles to the series in 2015, including the CAPS Grade 12 **Mind the Gap study guide for Mathematical Literacy**.

ISBN 78-1-4315-1936-1

Mind the Gap team

Series managing editor: Dr Patricia Watson

Production co-ordinators: Lisa Treffry-Goatley and Radha Pillay

Production assistants: Nomathamsanqa Hlatshwayo and Motshabi Mondlane

Authors: Michael William Fortuin, Denise Antoinette Grootboom, Madikhungwane Naughty Mbanyane, Zandile Mdiniso, Simangele Linda Cynthia Mnisi, Motshidisi Martha Moatlhodi, Raesetja Gladys Mogoroga, Setwadi Stewart William Mokgako, Nomsa Motshoane, Khonziphi Dolly Happy Ngema and Karen van Niekerk

Expert readers: Julie Hannah, Sue Jobson, Thomas Masango and John Ostrowick

Proofreaders: John Ostrowick and Angela Thomas

Designers: Sonja McGonigle and Erika van Rooyen

Illustrators: Michele Dean, Vusi Malindi, Khosi Pholosa, John Ostrowick, Kenneth Tekane

Cover illustration: Alastair Findlay

Afrikaans Translation: Johan Steenkamp

Onsite writers' workshop IT support: Wayne Cussons

Special thanks to Winning Teams, CEO Denzil Hollis, for the organisation's subject expertise and workshop support.

Winning Teams board game facilitators: Mantse Khoza and Sue Jobson

Ministerial foreword

The Department of Basic Education (DBE) has pleasure in releasing the second edition of the *Mind the Gap* study guides for Grade 12 learners. These study guides continue the innovative and committed attempt by the DBE to improve the academic performance of Grade 12 candidates in the National Senior Certificate (NSC) examination.

The study guides have been written by teams of experts comprising teachers, examiners, moderators, subject advisors and coordinators. Research, which began in 2012, has shown that the *Mind the Gap* series has, without doubt, had a positive impact on grades. It is my fervent wish that the *Mind the Gap* study guides take us all closer to ensuring that no learner is left behind, especially as we celebrate 20 years of democracy.

The second edition of *Mind the Gap* is aligned to the 2014 Curriculum and Assessment Policy Statement (CAPS). This means that the writers have considered the National Policy pertaining to the programme, promotion requirements and protocols for assessment of the National Curriculum Statement for Grade 12 in 2014.

The CAPS aligned *Mind the Gap* study guides take their brief in part from the 2013 National Diagnostic report on learner performance and draw on the Grade 12 Examination Guidelines. Each of the *Mind the Gap* study guides defines key terminology and offers simple explanations and examples of the types of questions learners can expect to be asked in an exam. Marking memoranda are included to assist learners to build their understanding. Learners are also referred to specific questions from past national exam papers and examination memos that are available on the Department's website – www.education.gov.za.

The CAPS editions include Accounting, Economics, Geography, Life Sciences, Mathematics, Mathematical Literacy and Physical Sciences Part 1: Physics and Part 2: Chemistry. The series is produced in both English and Afrikaans. There are also nine English First Additional Language (EFAL) study guides. These include EFAL Paper 1 (Language in Context); EFAL Paper 3 (Writing) and a guide for each of the Grade 12 prescribed literature set works included in Paper 2. These are Short Stories, Poetry, *To Kill a Mockingbird*, *A Grain of Wheat*, *Lord of the Flies*, *Nothing but the Truth* and *Romeo and Juliet*. (Please remember when preparing for EFAL Paper 2 that you need only study the set works you did in your EFAL class at school.)

The study guides have been designed to assist those learners who have been underperforming due to a lack of exposure to the content requirements of the curriculum and aim to mind-the-gap between failing and passing, by bridging the gap in learners' understanding of commonly tested concepts, thus helping candidates to pass.

All that is now required is for our Grade 12 learners to put in the hours required to prepare for the examinations. Learners, make us proud – study hard. We wish each and every one of you good luck for your Grade 12 examinations.



Matsie Angelina Motshekga, MP
Minister of Basic Education

A handwritten signature in black ink, which appears to read 'Matsie Angelina Motshekga'. The signature is written in a cursive style and is positioned above a horizontal line.

Matsie Angelina Motshekga, MP
Minister of Basic Education
2015

Table of contents

Dear Grade 12 learner	vii
How to use this study guide	ix
Top 10 study tips	x
Mnemonics.....	xi
Mind maps.....	xii
On the day of the exam	xiii
Question words to help you answer questions.....	xiv
Vocabulary.....	xv
General terms	xv
Technical terms.....	xvii
The maths you need.....	xxvi
Unit 1: Numbers and calculations with numbers	1
1.1 Using a calculator	1
1.2 Common fractions	4
1.3 Decimals	4
1.4 Percentages	6
1.5 Ratio, proportion and rate.....	10
1.6 Rounding off according to the context	16
1.7 Squares and cubes of numbers	18
1.8 Time.....	20
Unit 2: Patterns and graphs	23
2.1 Making sense of graphs that tell a story.....	23
2.2 Plotting points on a graph grid	24
2.3 Reading information from a graph	25
2.4 Touching the axes.....	26
2.5 Graphs going up (increasing) and down (decreasing)	27
2.6 Continuous and discrete graphs	28
2.7 More than one line on the same graph	31
2.8 Direct and indirect proportion	34
2.9 Exponential number patterns and graphs	36
2.10 How to identify the kind of relationship in a graph	38
2.11 Reading the scale of a graph.....	39
Unit 3: Finance	41
3.1 Financial documents.....	41
3.2 Budgets, income and expenditure statements	57
3.3 Banking, interest and tax.....	63
3.4 Inflation	73
3.5 Payslips, deductions and tax	75

Unit 4: Measurement	79
4.1 Converting between different units of measurement	79
4.2 Measuring length.....	83
4.3 Measuring mass or weight.....	85
4.4 Measuring volume and capacity.....	88
4.5 Perimeter, area and volume.....	92
4.6 Calculating elapsed time	103
Unit 5: Maps, plans and other representations of the physical world	110
5.1 Scale.....	110
5.2 Maps.....	119
5.3 Plans.....	126
5.4 Models.....	136
Unit 6: Data handling	139
6.1 Developing research questions	139
6.2 Collecting data	140
6.3 Classifying and organising data.....	141
6.4 Summarising data	144
6.5 Representing, interpreting and analysing data	159
6.6 Misleading data	171
Unit 7: Probability	179
7.1 The probability scale	179
7.2 Games of chance.....	180
7.3 Using tree diagrams	183
7.4 Using a two-way table to show combined outcomes.....	187
7.5 Using predictions in various situations	190
7.6 False positives and false negatives.....	191

Dear Grade 12 learner

This *Mind the Gap* study guide helps you to prepare for the end-of-year CAPS Grade Maths Literacy 12 exams.

The study guide does NOT cover the entire curriculum, but it does focus on core content of each knowledge area and points out where you can earn easy marks.

You must work your way through this study guide to improve your understanding, identify your areas of weakness and correct your own mistakes.

To ensure a good pass, you should also cover the remaining sections of the curriculum using other textbooks and your class notes.

Overview of the Grade 12 exam

The following topics make up each of the TWO exam papers that you write at the end of the year:

TERM	GRADE 12	
1	Control Test	
2	Paper 1 2 hours (100 marks)	Paper 2 2 hours (100 marks)
3	Control Test	Control Test
	Paper 1 3 hours (150 marks)	Paper 2 3 hours (150 marks)
4	External Examinations	
	Paper 1 3 hours (150 marks)	Paper 2 3 hours (150 marks)

We are confident that this *Mind the Gap* study guide can help you to prepare well so that you pass the end-of-year exams.



	PAPER 1	PAPER 2
Intention	Basic skills' paper → assesses proficiency of content and/or skills	Applications' paper → assesses ability to use both mathematical and non-mathematical techniques/considerations to explore familiar and unfamiliar contexts.
Structure and scope of content and/or skills	<p>5 questions</p> <p>Four questions deal with contexts relating to each of the topics:</p> <ul style="list-style-type: none"> • Finance • Measurement • Maps, plans and other representations of the physical world • Data handling <p>Fifth question integrates content from across all of these topics.</p> <p>Likelihood will be examined in the context or one or more of the other questions.</p> <p>Each question can contain more than one context.</p>	<p>4 or 5 questions</p> <p>Each question deals with contexts drawing integrated content from across all of the topics:</p> <ul style="list-style-type: none"> • Finance • Measurement • Maps, plans and other representations of the physical world • Data handling <p>Likelihood will be examined in the context or one or more of the other questions.</p> <p>Each question can contain more than one context.</p>
	Level 1	60%
	Level 2	35%
	Level 3	5%
	Level 4	
		25%
		35%
		40%
Contexts	Familiar', i.e. limited to the contexts listed in the CAPS document.	Both 'familiar' and 'unfamiliar', i.e. not limited to the contexts listed in the CAPS document.

	Topic	Weighting (%)
Basic skills topics	Interpreting and communicating answers and calculations	No weighting is provided for these topics. Rather, they will be assessed in an integrated way throughout the Application Topics.
	Numbers and calculations with numbers	
	Patterns, relationships and representations	
Application topics	Finance	35% (±5%)
	Measurement	20% (±5%)
	Maps, plans and other representations of the physical world	15% (±5%)
	Data handling	25% (±5%)
	Likelihood	Minimum 5%

The four levels of the Mathematical Literacy assessment taxonomy	GRADE 12		
	PAPER 1	PAPER 2	OVERALL ALLOCATION
Level 1: Knowing	60% ± 5%		30% ± 5%
Level 2: Applying routine procedures in familiar contexts	35% ± 5%	25% ± 5%	30% ± 5%
Level 3: Applying multi-step procedures in a variety of contexts	5%	35% ± 5%	20% ± 5%
Level 4: Reasoning and reflecting	0	40% ± 5%	20% ± 5%







How to use this study guide

This study guide covers selected parts of the different topics of the CAPS Grade 12 curriculum in the order they are usually taught during the year. The selected parts of each topic are presented in the following way:

- An explanation of terms and concepts;
- Worked examples to explain and demonstrate;
- Activities with questions for you to answer; and
- Answers for you to use to check your own work.

Look out for these icons in the study guide.



	Pay special attention		Hints to help you remember a concept or guide you in solving problems		Worked examples
	Step-by-step instructions		Refers you to the exemplar paper		Activities with questions for you to answer

- The activities are based on exam-type questions. Cover the answers provided and do each activity on your own. Then check your answers. Reward yourself for things you get right. If you get any incorrect answers, make sure you understand where you went wrong before moving on to the next section.
- In these introduction pages, we will go through the mathematics that you need to know, in particular, algebra and graphs. These are crucial skills that you will need for any subject that makes use of mathematics. Make sure you understand these pages before you go any further.
- Go to www.education.gov.za to download past exam papers for you to practice.

Use this study guide as a workbook. Make notes, draw pictures, and highlight important concepts.



Top 10 study tips



- 1.** Have all your materials ready before you begin studying – pencils, pens, highlighters, paper, etc.
- 2.** Be positive. Make sure your brain holds on to the information you are learning by reminding yourself how important it is to remember the work and get the marks.
- 3.** Take a walk outside. A change of scenery will stimulate your learning. You'll be surprised at how much more you take in after being outside in the fresh air.
- 4.** Break up your learning sections into manageable parts. Trying to learn too much at one time will only result in a tired, unfocused and anxious brain.
- 5.** Keep your study sessions short but effective and reward yourself with short, constructive breaks.
- 6.** Teach your concepts to anyone who will listen. It might feel strange at first, but it is definitely worth reading your revision notes aloud.
- 7.** Your brain learns well with colours and pictures. Try to use them whenever you can.
- 8.** Be confident with the learning areas you know well and focus your brain energy on the sections that you find more difficult to take in.
- 9.** Repetition is the key to retaining information you have to learn. Keep going – don't give up!
- 10.** Sleeping at least 8 hours every night, eating properly and drinking plenty of water are all important things you need to do for your brain. Studying for exams is like strenuous exercise, so you must be physically prepared.

If you can't explain it simply, you don't understand it well enough.

Albert Einstein

Mnemonics

A mnemonic code is a useful technique for learning information that is difficult to remember.

Here's the most useful mnemonic for Mathematics, Mathematical Literacy, and Physical Science:

BODMAS:

B – Brackets

O – Of or Orders: powers, roots, etc.

D – Division

M – Multiplication

A – Addition

S – Subtraction



Throughout the book you will be given other mnemonics to help you remember information.

The more creative you are and the more you link your 'codes' to familiar things, the more helpful your mnemonics will be.

Education helps one cease being intimidated by strange situations.

Maya Angelou

Mind maps

There are several mind maps included in the Mind the Gaps guides, summarising some of the sections.

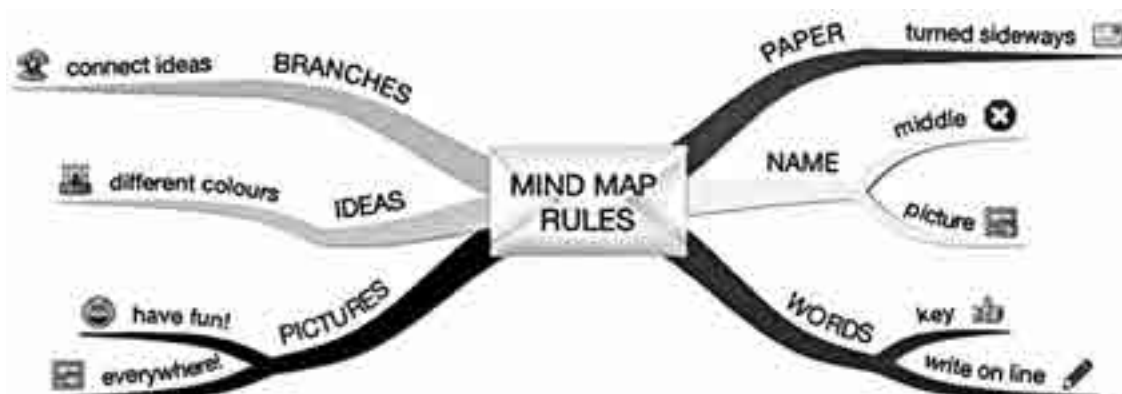

Mind maps work because they show information that we have to learn in the same way that our brains ‘see’ information.

As you study the mind maps in the guide, add pictures to each of the branches to help you remember the content.

You can make your own mind maps as you finish each section.

How to make your own mind maps:

1. Turn your paper sideways so your brain has space to spread out in all directions.
2. Decide on a name for your mind map that summarises the information you are going to put on it.
3. Write the name in the middle and draw a circle, bubble or picture around it.
4. Write only key words on your branches, not whole sentences. Keep it short and simple.
5. Each branch should show a different idea. Use a different colour for each idea. Connect the information that belongs together. This will help build your understanding of the learning areas.
6. Have fun adding pictures wherever you can. It does not matter if you can’t draw well.

Mind mapping your notes makes them more interesting and easier to remember.



On the day of the exam

1. Make sure you have all the necessary stationery for your exam, i.e. pens, pencils, eraser, protractor, compass, calculator (with new batteries). Make sure you bring your ID document and examination admission letter.
2. Arrive on time, at least one hour before the start of the exam.
3. Go to the toilet before entering the exam room. You don't want to waste valuable time going to the toilet during the exam.
4. Use the 10 minutes reading time to read the instructions carefully. This helps to 'open' the information in your brain. Start with the question you think is the easiest to get the flow going.
5. Break the questions down to make sure you understand what is being asked. If you don't answer the question properly you won't get any marks for it. Look for the key words in the question to know how to answer it. Lists of difficult words (vocabulary) is given a bit later on in this introduction.
6. Try all the questions. Each question has some easy marks in it so make sure that you do all the questions in the exam.
7. Never panic, even if the question seems difficult at first. It will be linked with something you have covered. Find the connection.
8. Manage your time properly. Don't waste time on questions you are unsure of. Move on and come back if time allows. Do the questions that you know the answers for, first.
9. Write big and bold and clearly. You will get more marks if the marker can read your answer clearly.
10. Check weighting – how many marks have been allocated for your answer? Take note of the ticks in this study guide as examples of marks allocated. Do not give more or less information than is required.



Question words to help you answer questions

It is important to look for the question words (the words that tell you what to do) to correctly understand what the examiner is asking. Use the words in the table below as a guide when answering questions.

Question word	What is required of you
Analyse	Separate, examine and interpret
Calculate	This means a numerical answer is required – in general, you should show your working, especially where two or more steps are involved
Classify	Group things based on common characteristics
Compare	Point out or show both similarities and differences between things, concepts or phenomena
Define	Give a clear meaning
Describe	State in words (using diagrams where appropriate) the main points of a structure/process/phenomenon/investigation
Determine	To calculate something, or to discover the answer by examining evidence
Differentiate	Use differences to qualify categories
Discuss	Consider all information and reach a conclusion
Explain	Make clear; interpret and spell out
Identify	Name the essential characteristics PAY SPECIAL ATTENTION
Label	Identify on a diagram or drawing
List	Write a list of items, with no additional detail
Mention	Refer to relevant points
Name	Give the name (proper noun) of something
State	Write down information without discussion
Suggest	Offer an explanation or a solution
Tabulate	Draw a table and indicate the answers as direct pairs

In every exam question, put a **CIRCLE** around the question word and **underline** any other important key words. These words tell you exactly what is being asked.



Vocabulary

The following vocabulary consists of all the difficult words used in Mind the Gap Mathematical Literacy. We suggest that you read over the list below a few times and make sure that you understand each term. Tick next to each term once you understand it so you can see easily where the gaps are in your knowledge.

KEY	
Abbreviation	Meaning
(v)	verb: doing-word or action word, such as “walk”
(n)	noun: naming word, such as “person”
(adj)	adjective: describing word such as “big”
(adv)	adverb: describing word for verbs, such as “fast”
(prep)	preposition: a word describing a position, such as “on”, “at”
(sing)	singular: one of
(pl)	plural: more than one of
(abbr)	abbreviation

General terms

Term	Meaning
A	
abbreviate	(v). Make shorter.
account for	(v). Explain why.
adjacent	(adj). Next to something.
analyse	(v). Examine something in detail.
annotated	(adj). Something that has comments or explanations, usually written, added to it.
ante-	(prep). Before (e.g., ante-natal – before birth)
anti-	(prep). Against (e.g., anti-apartheid – against apartheid).
approximate	(v. & adj.). Come close to (v); roughly, almost, not perfectly accurate, close but not exact. The verb is pronounced “approxi-mayt” and the adjective is pronounced “approxi-mitt”.
arbitrary	(adj). Based on random choice; unrestrained and autocratic.

C	
category	(n). Class or group of things.
consecutive	(adj). One after another without any gaps or breaks.
consider	(v). Think about.
contrast	(v). Show the difference between; (n) something that is very different from what it is being compared with.
conversely	(adv). The opposite of.
D	
data (pl), datum (sing)	(n). Information given or found.
deduce	(v). To work something out by reasoning.
deduction	(n). Conclusion or idea that someone has worked out.
define	(v). Give the meaning of a word or words.
definition	(n). The meaning of a word or words.
denote	(v). To refer to or mean something.
determine	(v). Work out, usually by experiment or calculation.
E	
elapse	(v). Pass by or finish, e.g., time.
establish	(v). Show or prove, set up or create.
exceed	(v). Go beyond.
excess	(n). More than necessary.
excluding	(prep). Not including.
exclusive	(adj). Excluding or not admitting other things; reserved for one particular group or person.
exemplar	(n). A good or typical example.
exempt	(v). To free from a duty.
exempt	(adj). Be freed from a duty.
exemption	(n). Being freed from an obligation.
extent	(n). The area covered by something.
F	
factor	(n). A circumstance, fact or influence that contributes to a result; a component or part.
factory	(n). A place where goods are made or put together from parts.

find	(v). Discover or locate.
find	(n). Results of a search or discovery.
finding	(n). Information discovered as the result of an inquiry.
fixed	(adj). Not able to move, attached; or repaired, not broken.
format	(n). Layout or pattern; the way something is laid out.
G	
global	(adj). Found all over the world (globe).
I	
identify	(v). Recognise or point out.
illustrate	(v). Give an example to show what is meant; draw.
imply	(v). Suggest without directly saying what is meant.
indicate	(v). Point out or show.
initial	(n). First.
initiation	(n). The action of beginning something; the action of admitting somebody into a group or organisation.
inter-changeable	(adj). Can be swapped or exchanged for each other.
investigate	(v). Carry out research or a study.
issues	(v). Comes out of.
issues	(n). An important problem or a topic for debate.
M	
magnitude	(adj). Size.
manipulate	(v). Handle or control (a thing or a person).
motivate	(v). Give someone a reason for doing something.
multiple	(adj). Many.
N	
negligible	(adj). Small and insignificant; can be ignored. From “neglect” (ignore).
numerical	(adj). Relating to or expressed as a number or numbers.
numerous	(adj). Many.

O	
obtain	(v). Get.
optimal	(adj). Best; most favourable.
optimum	(adj). Best; (n) the most favourable situation for growth or success.
P	
principal	(n). Head of a school.
principal	(adj). Main or most important.
principle	(n). A basic truth that guides the way a person behaves.
priority	(n). Something that is considered to be more important or comes first.
provide	(v). Make available for use; supply.
Q	
quality	(n). The standard of something compared to other similar things; a characteristic of someone or something.
R	
reciprocal	(adj). Given or done in return.
record	(v). Make a note of something in order to refer to it later (pronounced ree-cord).
record	(n). A note made in order to refer to it later; evidence of something; a copy of something (pronounced rec-cord).
represent	(v). Be appointed to act or speak for someone; amount to.
resolve	(v). Finalise something or make it clear; bring something to a conclusion.
respect	(v). Admire something or someone; consider the needs or feelings of another person.
respectively	(adj). In regards to each other, in relation to items listed in the same order.
S	
simultaneously	(adv). At the same time.
site	(n). Place.

suffice	(v). Be enough.
surplus	(adj). More than is needed.
survey	(n). A general view, examination, or description of someone or something.
survey	(v). Look closely at or examine; consider a wide range of opinions or options.
T	
tendency	(n). An inclination to do something in a particular way; a habit.
tertiary	(adj). Third level.
truncated	(adj). Cut short.
U	
under-reported	(adj). Not reported enough; there is not enough information.
V	
verify	(v). Show to be true; check for truth; confirm.
vice versa	(adv). The other way round.
versus	(prep). Against. Abbreviated “vs” and sometimes “v”.

Technical terms

A	
account	(n. & v.). Finance: A record of income and expenditure. To explain (v), e.g. “Account for why the sky is blue”.
algebra	(n). A mathematical system where unknown quantities are represented by letters, which can be used to perform complex calculations through certain rules.
angel	(n). In Abrahamic religions, a messenger from God. Note the spelling.
angle	(n). The difference in position between two straight lines which meet at a point, measured in degrees. Note the spelling.

annual	(adj). Once every year. (E.g. “Christmas is an annual holiday”).
annum, per	(adv). For the entire year. (E.g. “You should pay R 100 per annum”).
area	(n). Length x breadth (width). In common usage: a place.
asset	(n). Something having value, which can be sold to defray (get rid of) debts. Can refer to physical things such as houses, cars, etc., or to savings and investments.
ATM	(n). Abbreviation: automatic teller machine.
average	(n). Mathematics: The sum of parts divided by the quantity of parts. In common use: neither very good, strong, etc., but also neither very weak, bad, etc; the middle. If you are asked to find the average, you always have to calculate it using the information you have. For example, the average of (1;2;3) is 2, because $(1+2+3)/3 = 2$. See also mean, median and mode.
axis (sing), axes (pl, pronounced “akseez”)	(n). A line along which points can be plotted (placed), showing how far they are from a central point, called the origin. See origin. “Vertical axis” or “y-axis” refers to how high up a point is above the origin (or how far below). “Horizontal axis” or “x-axis” refers to how far left or right a point is away from the origin.
B	
bias	(n). To be inclined against something or usually unfairly opposed to something; to not accurately report on something; to favour something excessively.
BMI	(n). Body mass index. Calculated by dividing someone’s weight in kilograms by the square of his or her height in metres. An indication of whether someone is over- or underweight.
BODMAS	(abbr.). Brackets, of/orders (powers, squares, etc), division, multiplication, addition, subtraction. A mnemonic (reminder) of the correct order in which to do mathematical operations.

borrow vs lend	(v). To take something (e.g. money) from someone with their permission for temporary use (borrow). Lend means the opposite: it means to give money to someone for temporary use. Remember: Borrow from, lend to. Can refer to financial transactions. If you take money from a bank, you are the borrower and the bank is the lender.
breadth	(n). How wide something is. From the word “broad”.
budget	(n. & v.). To plan how to spend money (v); a plan of how to spend money (n); an estimate of the amount of money available (n).
C	
Cartesian	(adj). Anything believed or proposed by Rene Descartes. In particular, the x-and-y axis coordinate system.
cash	(n). Printed or minted money, money not represented by cheques, cards, etc.
cashier	(n). Person who receives payment.
CFL	(n). Compact Fluorescent Light; a small fluorescent tube curled up inside a standard lightbulb shape.
chance	(n). The same as possibility or likelihood; that something might happen but that it is hard to predict whether it will.
chart	(v). To draw a diagram comparing values on Cartesian axes.
cheque	(n). A bill issued by banks, and filled in by the drawer (the person writing it), to represent an amount owed, usually with place to state who the amount is due to.
circumference	(n). The distance around the outer rim of a circle.
compound interest	(n). Interest charged on an amount due, but including interest charges to date. Compare to simple interest.
continuous	(adj). Mathematics: having no breaks between mathematical points; an unbroken graph or curve represents a continuous function. See function.

control	(n. and v.). To ensure something does not change without being allowed to do so (v); an experimental situation to which nothing is done, in order to compare to a separate experimental situation, called the ‘experiment’, in which a change is attempted. The control is then compared to the experiment to see if a change happened.
control variable	(n). A variable that is held constant in order to discover the relationship between two other variables. “Control variable” must not be confused with “controlled variable” (see independent variable).
coordinate	(n). The x or y location of a point on a Cartesian graph, given as an x or y value. Coordinates (pl) are given as an ordered pair (x, y).
correlate	(v). To see or observe a relationship between two things, without showing that one causes the other.
correlation	(n). That there is a relationship between two things, without showing that one causes the other.
correspond	(v). To pair things off in a correlational relationship. For two things to agree or match. E.g. A corresponds to 1, B corresponds to 2, C corresponds to 3, etc.
credit	(n. & v.). To lend someone money (v); to have a certain amount of money that is not one’s own that was lent to one (n). Credit limit: how much money you have borrowed or may borrow against.
cubed	(adj). The power of three; multiplied by itself three times.
cubic	(adj). Shaped like a cube; having been multiplied by itself three times.
cylinder	(n). A tall shape with parallel sides and a circular cross-section – think of a log of wood, for example, or a tube. See parallel. The formula for the volume of a cylinder is $\pi r^2 h$.
D	
debit	(v. & n.). When someone or an organisation takes money out of your account. Compare to withdraw.

debt	(n). The state of owing money.
deficit	(n). Excess spending, or, the difference between the amount owed and the amount paid; shortfall; the excess of expenditure (spending) or liabilities (debts) over income (earnings) or assets.
denominator	(n). See divisor. In popular speech: a common factor.
depend	(v). To be controlled or determined by something; to require something to happen or exist first.
dependent (variable)	(adj/n). A variable whose value depends on another; the thing that comes out of an experiment, the effect; the results. See also independent variable and control variable. The dependent variable has values that depend on the independent variable, and we plot it on the vertical axis.
deposit	(n). Finance: to place money into an account.
derivation	(n). Mathematics: to show the working of your arithmetic or answer or solution; the process of finding a derivative.
derivative	(n). Mathematics: The rate of change of a function with respect to an independent variable. See independent variable. In common use: something that comes from something else.
diagonal	(adj. & n.). A line joining two opposite corners of an angular shape.
diameter	(n). The line passing through the centre of a shape from one side of the shape to the other, esp. a circle. Formula: $d = 2r$. See radius, radii, circumference.
difference	(n). Mathematics: subtraction. Informally: a dissimilarity. How things are not the same.
dimension	(n). A measurable extent, e.g. length, breadth, height, depth, time. Physics, technical: the base units that make up a quantity, e.g. mass (kg), distance (m), time (s).
distribution	(n). How something is spread out. Mathematics: the range and variety of numbers as shown on a graph.

divisor	(n). The number below the line in a fraction; the number that is dividing the other number above the fraction line. See numerator, denominator.
domain	(n). The possible range of x-values for a graph of a function. See range.
E	
element	(n). Mathematics: part of a set of numbers. Popular use: part of.
elevation	(n). Science: height above the ground or sea level. Architecture: a face of a building as viewed from a certain direction on an architect's plan of the building. See plan.
eliminate	(v). To remove or get rid of. Mathematics: to cancel a factor out of one side of an equation by dividing by that factor throughout, or by substituting in another formula or value that is equal.
expenditure	(n). How much money, time, or effort has been used on something.
expense	(n). How much something costs in time, money, or effort.
expensive	(adj). Using too much time, money or effort.
exponent	(n). When a number is raised to a power, i.e. multiplied by itself as many times as shown in the power (the small number up above the base number). So, 2^3 means $2 \times 2 \times 2$. See also cubed.
exponential	(adj). To multiply something many times; a curve representing an exponent.
extrapolation	(n). To extend the line of a graph further, into values not empirically documented, to project a future event or result. In plain language: to say what is going to happen based on past results which were obtained (gotten) by experiment and measurement. If you have a graph and have documented certain results (e.g. change vs time), and you draw the line further in the same curve, to say what future results you will get, that is called 'extrapolation'. See predict.

F	
fraction	(n). Mathematics: Not a whole number; a representation of a division. A part. E.g. the third fraction of two is 0,666 or $\frac{2}{3}$. meaning two divided into three parts.
frequency	(n). How often.
function	(n). Mathematics: when two attributes or quantities correlate. If y changes as x changes, then $y = f(x)$. See correlate, graph, Cartesian, axis, coordinate. Also: a relation with more than one variable (mathematics).
fund	(n. & v.). A source of money (n); to give money (v).
G	
gradient	(n). A slope. An increase or decrease in a property or measurement. Also the rate of such a change. In the formula for a line graph, $y = mx + c$, m is the gradient.
graph	(n). A diagram representing experimental or mathematical values or results. See Cartesian.
graphic	(n., adj.). A diagram or graph (n). Popular use: vivid or clear or remarkable (adj.).
graphically	(adv). Using a diagram or graph. Popular use: to explain very clearly.
H	
histogram	(n). A bar graph that represents continuous (unbroken) data (i.e. data with no gaps). There are no spaces between the bars. A histogram shows the frequency, or the number of times, something happens within a specific interval or “group” or “batch” of information.
hyperbola	(n). Mathematics: a graph of a section of a cone with ends going off the graph; a symmetrical (both sides the same) open curve.
hypotenuse	(n). The longest side of a right-angled triangle.

I	
incline	(n. & v.). Slope. See gradient (n); to lean (v).
independent (variable)	(n). The things that act as input to the experiment, the potential causes. Also called the controlled variable. The independent variable is not changed by other factors, and we plot it on the horizontal axis. See control, dependent variable.
inflation	(n). That prices increase over time; that the value of money decreases over time. General use: the action of getting bigger.
informal sector	(n). Not part of the formal economy; street vendors or home workers; self-employed persons who have not formally registered a corporation or company but are manufacturing or selling items or work.
insufficient	(adj). Not enough.
insurance	(n). Finance: an agreement with an insurance company in which money is paid to guarantee against or compensate for future mishaps or losses. See premium. General use: something that is set up to prevent against future loss or mishap.
interest	(n). Finance: money paid regularly at a particular rate for the use or loan of money. It can be paid by a finance organisation or bank to you (in the case of savings), or it may be payable by you to a finance organisation on money you borrowed from the organisation. See compound interest and simple interest, see also borrow.
intermediate	(adj). A state in between.
interquartile	(adj). Between quartiles. See quartile.
interval	(n). Gap. A difference between two measurements.
inverse	(n). The opposite of. Mathematics: one divided by. E.g. $\frac{1}{2}$ is the inverse of 2.
invest	(v). To put money into an organisation or bank (e.g. in buying shares) so as to gain interest on the amount at a higher rate. See interest.

investment	(n). Something in which you have invested money (time, or effort, in common usage).
investor	(n). A person who has invested (usually money).
invoice	(n). A formal request for payment (in writing). It will usually state the name of the supplier or vendor (shop); the address of the shop or company that is requesting the amount; the VAT number of the shop; the words "Tax Invoice"; the shop's invoice number; the date and time of the sale; a description of the items or services bought; the amount of VAT charged (14%); the total amount payable.
K	
kWh	(abbr). Unit of power (kilowatt hours) that electricity suppliers charge for. See power, watt. 1000 watts used in 1 hour = 1kWh = 1 unit. So e.g. a 2000 W heater uses 2 units per hour.
L	
liability	(n). To owe, or to have something that causes one to be in debt; something that causes you to have to spend money; a legal or financial responsibility.
likely	(adj). To be probable; something that might well happen.
linear	(adj). In a line. Mathematics: in a direct relationship, which, when graphed with Cartesian coordinates, turns out to be a straight line.
logarithm	(n). Mathematics: a quantity representing the power by which a fixed number (the base) must be raised to produce a given number. The base of a common logarithm is 10, and that of a natural logarithm is the number e (2,7183...). A log graph can turn a geometric or exponential relationship, which is normally curved, into a straight line.

longitude	(n). Lines running north to south on the earth, measuring how far east or west one is, in degrees, from Greenwich in the UK. "Longitudinal" (adj) means from north to south, or top to bottom. Running lengthwise. Physics: a wave whose vibrations move in the direction of propagation (travel). Example: sound. Statistics: a study in which information is gathered about the same people or phenomena over a long period of time.
M	
magnitude	(n). Size.
manipulate	(v). To change, or rearrange something. Usually in Mathematics it means to rearrange a formula to solve for (to get) an answer.
mean	(n). See average.
mechanical	(n). By means of physical force.
median	(n). Mathematics: the number in the middle of a range of numbers written out in a line or sequence.
member	(n). A part of. Finance: a person or legal entity who is partial owner of a company.
meter	(n). A device to measure something. You might see this spelling used in American books for metre. See metre.
metre	(n). The SI unit of length, 100 cm.
metric	(adj). A measurement system, using a base of 10 (i.e. all the units are divisible by 10). The USA uses something known as the Imperial system, which is not used in science. The Imperial system is based on 12. Examples: 2,54 cm (metric) = 1 inch (imperial). 1 foot = 12 inches = approx. 30 cm; 1 metre = 100 cm. 1 Fl.Oz (fluid ounce) = approx 30 ml.
minimise	(v). To make as small as possible.
minimum	(n). The smallest amount possible.
modal	(adj). Pertaining to the mode, or method. Can mean: about the mathematical mode or about the method used. See mode.
mode	(n). Mathematics: the most common number in a series of numbers. See also mean, median.

model	(n). A general or simplified way to describe an ideal situation, in science, a mathematical description that covers all cases of the type of thing being observed. A representation.
N	
numerator	(n). The opposite of a denominator; the number on top in a fraction.
O	
optimal	(adj). Best, most.
origin	(n). Mathematics: the centre of a Cartesian coordinate system. General use: the source of anything, where it comes from.
outlier	(n). Statistics: a data point which lies well outside the range of related or nearby data points.
P	
parallel	(adj). Keeping an equal distance along a length to another item (line, object, figure). Mathematics: two lines running alongside each other which always keep an equal distance between them.
particular	(adj). A specific thing being pointed out or discussed; to single out or point out a member of a group.
PAYE	(abbr). Pay as you earn, tax taken off your earnings by your employer and sent to the South African Revenue Service before you are paid.
per	(prep). For every, in accordance with.
per annum	(adv). Once per year; for each year.
percent	(adv). For every part in 100. The rate per hundred.
percentile	(n). A division of percentages into subsections, e.g. if the scale is divided into four, the fourth percentile is anything between 75 and 100%.
perimeter	(n). The length of the outer edge; the outer edge of a shape.
period	(n). The time gap between events; a section of time.

periodic	(adj). Regular; happening regularly.
perpendicular	(adj). At right angles to (90°).
pi	(n). π , the Greek letter p, the ratio of the circumference of a circle to its diameter. A constant without units, value approximately 3,14159.
plan	(n). Architecture: a diagram representing the layout and structure of a building, specifically as viewed from above. More general use: any design or diagram, or any intended sequence of actions, intended to achieve a goal.
plot	(v). To place points on a Cartesian coordinate system; to draw a graph.
policy	(n). Finance: a term referring to an account held with an insurance company; an agreement that the company insures you. General use: a prescribed course of action.
predict	(v). General use: to foresee. Mathematics: see extrapolation.
premium	(n). An amount paid by you to an insurance company for your policy. See policy. General use: expensive or valuable.
probability	(n). How likely something is. See likely. Probability is generally a mathematical measure given as a decimal, e.g. [0] means unlikely, but [1,0] means certain, and [0,5] means just as likely versus unlikely. [0,3] is unlikely, and [0,7] is quite likely. The most common way to express probability is as a frequency, or how often something comes up. E.g. an Ace is 1/13 or 0,077 likely, in a deck of cards, because there are 4 of them in a set of 52 cards.
product	(n). Mathematics: the result of multiplying two numbers.
project	(n. & v.). A project (n., pronounced PRODJ-ekt) is a plan of action or long-term activity intended to produce something or reach a goal. To project (v., pronounced prodj-EKT), is to throw something, or to guess or predict (a projection). To project a result means to predict a result. See extrapolate.

proportion	(n). To relate to something else in a regular way, to be a part of something in relation to its volume, size, etc; to change as something else changes. See correlate and respectively.
Pythagoras's Theorem	(n). The square on the hypotenuse is equal to the sum of the squares on the other two sides of a right-angled triangle. Where h is the hypotenuse, a is the side adjacent to the right angle, and b is the other side: $h^2 = a^2 + b^2$.
Q	
qualitative	(adj). Relating to the quality or properties of something. A qualitative analysis looks at changes in properties like colour, that can't be put into numbers. Often contrasted with quantitative.
quantitative	(adj). Relating to, or by comparison to, quantities. Often contrasted with qualitative. A quantitative analysis is one in which you compare numbers, values and measurements.
quantity	(n). Amount; how much.
quartile	(n). A quarter of a body of data represented as a percentage. This is the division of data into 4 equal parts of 25% each. To determine the quartiles, first divide the information into two equal parts to determine the median (Q2), then divide the first half into two equal parts, the median of the first half is the lower quartile (Q1), then divide the second half into two equal parts, and the median of the second half is the upper quartile (Q3). Data can be summarised using five values, called the five number summary, i.e. the minimum value, lower quartile, median, upper quartile, and maximum value.
R	
radius (sing), radii (plur)	(n). The distance between the centre of an object, usually a circle, and its circumference or outer edge. Plural is pronounced "ray-dee-eye."

random	(n). Unpredictable, having no cause or no known cause. Done without planning.
range	(n). Mathematics: the set of values that can be supplied to a function. The set of possible y-values in a graph. See domain.
rate	(n). How often per second (or per any other time period). Finance: the exchange rate or value of one currency when exchanged for another currency; how many units of one currency it takes to buy a unit of another currency. Also "interest rate", or what percentage of a loan consists of interest charges or fees.
ratio	(n). A fraction; how one number relates to another number; exact proportion. If there are five women for every four men, the ratio of women to men is 5:4, written with a colon (:). This ratio can be represented as the fraction $\frac{5}{4}$ or $1\frac{1}{4}$ or 1,25; or we can say that there are 25% more women than men.
rebate	(n. & v.). To send some money back to a person who has paid too much (v). An amount sent back to someone who has paid too much (n).
receipt	(n). Finance: a piece of paper or other evidence sent to show that an amount was paid and that the person who received it (recipient) wishes to acknowledge (show) that they received (got) it.
receive	(v). To get something.
reception	(n). The process of receiving something. In common use, it can mean to greet people or "receive" them in your house. It can also refer to receiving (getting) a radio or microwave signal, e.g. in a cellphone or radio.
refund	(n). To send back a full payment made by someone who has paid incorrectly. See rebate.
remainder	(n). Leftovers. Mathematics: an amount left over after division which cannot be divided further unless one wishes to have a decimal or fraction as a result, i.e. where the divisor does not exactly divide the numerator by an integer (whole number).

S	
scale	(n). A system of measurement, with regular intervals or gaps between units (subdivisions) of the scale.
sector	(n). General use: a subdivision. In Economics or Finance: a part of the economy that is responsible for a particular industry or performs a particular service.
simple interest	(n). Interest charged on the original amount due only, resulting in the same fee every time.
simplify	(v). To make simpler. Mathematics: to divide throughout by a common factor (number or algebraic letter) that will make the equation easier to read and calculate.
solution	(n). Mathematics: the step-by-step displaying of calculations to arrive at answers. Common use: the answer to a problem, in the sense of dissolving (removing) a problem.
solve	(v). To come up with a solution (answer). Show your working.
square	(n). Mathematics: a shape or figure with four equal sides and only right angles; the exponent 2 (e.g. the square of 4 is $4^2 = 16$).
squared	(adj). Having been multiplied by itself, put to the exponent 2. See square.
statement	(n). Finance: a summary of transactions (debits and credits, or payments and receipts) made on an account. See account, debit, credit.
statistics	(n). The mathematics of chance and probability.
subscript	(n). A number placed below the rest of the line, e.g. CO ₂ .
substitute	(v). To replace.
substitution	(n). The process of substituting. Mathematics: to replace an algebraic symbol in a formula with a known value or another formula, so as to simplify the calculation. See simplify.
subtotal	(n). Finance: the total amount due on a statement or invoice, usually without VAT (tax) charges given. Or: a total for a section of an invoice or statement or series of accounts, but not the total of the whole invoice, statement or account.

sum	(n. & v.). To add things up. Represented by Greek Sigma (Σ): Σ or the plus sign (+).
superscript	(n). A number placed above the rest of the line, e.g. πr^2 .
T	
tally	(n). A total count; to count in fives by drawing four vertical lines then crossing through them with the fifth line.
tangent	(n). Mathematics: a straight line touching a curve only at one point, indicating the slope of the curve at that point; the trigonometric function of the ratio of the opposite side of a triangle to the adjacent side of a triangle in a right-angled triangle; a curve that goes off the chart.
tax	(n). A compulsory levy imposed on citizens' earnings or purchases to fund the activities of government.
taxable	(adj). A service, purchase or item or earning that has a tax applied to it.
transaction	(n). Finance: Exchanging money (payment or receipt); a credit and a debit.
transfer	(n). To move from one place to another. Finance: usually refers to a payment or credit. See credit, debit, transaction.
trends	(n). Mathematics: regular patterns within data.
trigonometry	(n). Mathematics: the relationship and ratios between sides and angles within a right-angled triangle.
U	
UIF	(abbr). Unemployment Insurance Fund. A government-run insurance fund which employers and employees contribute to, so that when employees are retrenched they can still collect some earnings.
unit	(n). A subdivision of a scale. See scale.

V	
variable	(n. & adj.). A letter used to represent an unknown quantity in algebra (n); a quantity that changes (n); subject to change (adj).
volume	(n). A measure of the space occupied by an object, equal to length x breadth x height.
W	
watt	(n). Unit of power or rate of use of energy.

wattage	(n). The amount of power being used, usually rated in kWh. See kWh.
withdraw	(v). To remove. Finance: to take money out of an account that belongs to you. Compare debit.
Y	
yard	(n). Old Imperial measurement of length, approximately equal to a metre (1,09 m).

The maths you need

This section gives you the basic mathematical skills that you need to pass any subject that makes use of mathematics. Do not go any further in this book until you have mastered this section.

1. Basic Pointers

- If a formula does not have a multiplication (\times) sign or a dot-product (\cdot), and yet two symbols are next to each other, it means “times”. So, m_1m_2 means *mass 1* times *mass 2*. You can also write it as $m_1 \times m_2$, or $m_1 \cdot m_2$
- Comma means the same as decimal point on your calculator (i.e. $4,5 = 4.5$). Do not confuse the decimal point with dot product (multiply): $4,5 = 4\frac{1}{2}$ but $4 \cdot 5 = 20$. Rather avoid using the dot product for this reason.
- A variable is something that varies (means: changes). So, for example, the weather is a variable in deciding whether to go to the shops. Variables in science and mathematics are represented with letters, sometimes called algebraic variables. The most common you see in maths is x , probably followed by y , z .

2. Subject of Formula or Solving For

Very often in mathematics you have to “make something the subject of a formula” or “solve for something”. This refers to finding the value of an unknown quantity if you have been given other quantities and a formula that shows the relationship between them.

The word ‘formula’ means a rule for working something out. We work with formulas to draw graphs and also to calculate values such as area, perimeter and volume. You are usually given the formulas in an exam question, so you don’t have to remember them, but you do need to select the right numbers to put into the formula (substitute). For example, the formula for the area of a triangle is

$$\text{Area} = \frac{1}{2} \text{base} \times \text{height}.$$

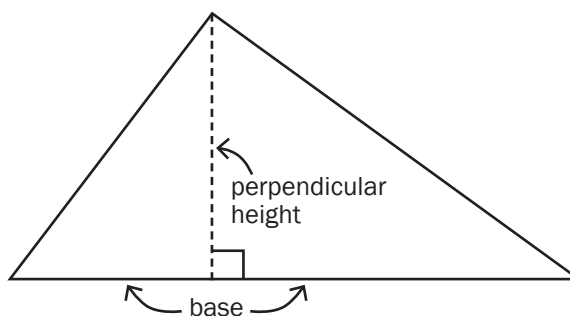

In this formula:

- the word *Area* stands for the size of the area of a triangle (the whole surface that the triangle covers)
- the word *base* stands for the length of the base of the triangle
- the word *height* stands for the length of the perpendicular height of the triangle.

A formula can be written in letters rather than words, for example:

$$A = \frac{1}{2} b \times h.$$

The quantity on its own on the left is called the subject of the formula.



Worked example 1

If John has 5 apples, and he gives some to Joanna, and he has two apples left, how many did he give to Joanna? Well, the formula would be something like this:

$$5 - x = 2$$

To solve for x , we simply have to swap the x and the 2. What we're actually doing is adding " x " to both sides:

$$5 - x + x = 2 + x$$

this becomes:

$$5 = 2 + x$$

then we subtract 2 from both sides to move the 2 over:

$$5 - 2 = 2 - 2 + x$$

$$5 - 2 = x$$

$$3 = x \quad \dots \text{ so John gave Joanna three apples.}$$

The same procedures apply no matter how complex the formula looks. Just either add, subtract, square, square root, multiply or divide throughout to move the items around.



Worked example 2

Let's take an example from Physical Science: $V = IR$. This means, the voltage in a circuit is equal to the current in the circuit times the resistance.

Suppose we know the voltage is 12 V, and the resistance is 3 Ω . What is the current?

$$V = IR$$

$$12 = 3 \times I$$

divide throughout by 3 so as to isolate the I

$$\frac{12}{3} = \left(\frac{12}{3}\right) I$$

remember that anything divided by itself is 1, so:

$$\frac{12}{3} = (1) \times I \quad \dots \text{ and } \frac{12}{3} = 4 \quad \dots \text{ so}$$

$$4 = I \text{ or}$$

$$I = 4 \text{ A } \dots \text{ The circuit has a current of 4 amperes.}$$



Worked example 3

Here's a more tricky example from Physical Science. Given

$$K_c = 4,5$$

$$[\text{SO}_3] = 1,5 \text{ mol/dm}^3$$

$$[\text{SO}_2] = 0,5 \text{ mol/dm}^3$$

$$[\text{O}_2] = \frac{(x-48)}{64} \text{ mol/dm}^3$$

solve for x .

$$K_c = \frac{[\text{SO}_3]^2}{[\text{SO}_2]^2[\text{O}_2]} \quad \therefore 4,5 = \frac{(1,5)^2}{(0,5)^2 \frac{(x-48)}{64}}$$

$$\therefore x = 176 \text{ g}$$

How did we get that answer?



Step by Step

Let's see how it works.

First, solve for the exponents (powers):

$$4,5 = \frac{2,25}{(0,25) \frac{(x-48)}{64}}$$

Now, we can see that 2,25 and 0,25 are similar numbers (multiples of five), so let's divide them as shown.

$$4,5 = \frac{2,25}{0,25} \times \frac{x-48}{64}$$

That leaves us with

$$4,5 = 9 \times \frac{(x-48)}{64}$$

But if we're dividing a divisor, that second divisor can come up to the top row. Here's a simple example:

$$\begin{aligned} 1 \div (2 \div 3) &= \frac{1}{\frac{2}{3}} \\ &= \frac{1 \times 3}{2} \\ &= \frac{3}{2} = 1,5 \end{aligned}$$

If you doubt this, try it quickly on your calculator: $1 \div (2 \div 3)$... this means, one, divided by two-thirds. Well, two-thirds is 0,6667, which is almost one. So how many "two-thirds" do you need to really make up one? The answer is one and a half "two-thirds" ... i.e. $0,6667 + (0,6667 \div 2) = 1$. Hence the answer is 1,5.

So, back to the original problem, we can bring the 64 up to the top line and multiply it by nine:

$$4,5 = 9 \times \left(\frac{x-48}{64} \right)$$

$$4,5 = \frac{9 \times 64}{x-48}$$

$$4,5 = \frac{576}{x-48}$$

Now we can inverse the entire equation to get the x onto the top:

$$\frac{1}{4,5} = \frac{x-48}{576}$$

Now we multiply both sides by 576 to remove the 576 from the bottom row

$$\frac{576}{4,5} = \frac{(x - 48) 576}{576}$$

and we cancel the 576's on the right hand side as shown above. Now, if $576 \div 4,5 = 128$, then $128 = x - 48$

Now we add 48 to both sides to move the 48 across

$$128 + 48 = x - 48 + 48 \dots \text{hence, } 128 + 48 = x = 176.$$



Worked example 4

A triangle has a base of 6 cm and a perpendicular height of 2 cm. Determine its area.

Step 1: Write down the value that you need to find.	Need to find: Area
Step 2: Write down the information that you have. Write down the numbers and the units.	base = 6 cm height = 2 cm
Step 3: Write down the formula that you are going to use.	Area = $\frac{1}{2}$ base \times height
Step 4: Write down the formula again, but write the numbers that you know instead of the words or letters.  We call this process substituting.	Area = $\frac{1}{2} \times 6 \text{ cm} \times 2 \text{ cm}$
Step 5: Now calculate.	= 3 cm \times 2 cm
Step 6: Write your answer with the correct units.	= 6 cm ²



Worked example 5

Calculate the area and the perimeter of the triangle alongside.

This looks like an easy problem, but you need to stay on your toes. As you follow the steps you will see why.

Step 1: Write down what you need to find.	Need to find: Area and Perimeter. Let's start with area.
Step 2: Write down the information that you have.	From the diagram: base = 110 cm height = 1,2 m The sides of the triangle are at right angles to each other, so one side is the perpendicular height.  The units of the two lengths are not the same. Always write the values with the same units. height = 1,2 m = 120 cm (because 100 cm = 1 m)
Step 3: Write down the formula.	Area = base \times height

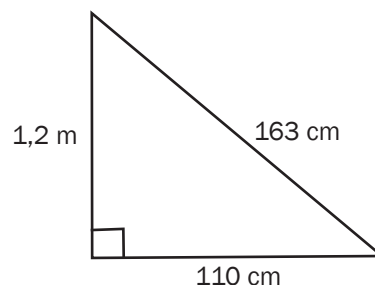

Step 4: Write down the formula again, but write the numbers that you know instead of the words.	Area = $\frac{1}{2} \times 110 \text{ cm} \times 120 \text{ cm}$
Step 5: Now calculate.	= $55 \text{ cm} \times 120 \text{ cm}$
Step 6: Write your answer with the correct units.	= $6\,600 \text{ cm}^2$
Step 7: Calculate the perimeter.	Perimeter = $120 + 163 + 110$ = 393 cm

Worked example 6

In the United States, people use degrees Fahrenheit to measure temperature. Convert 67°F into degrees Celsius ($^\circ\text{C}$). Round off your answer to two decimal places.

The formula to use is $^\circ\text{C} = (^\circ\text{F} - 32^\circ) \div 1,8$.

Need to find: Temperature in degree Celsius.	Notes
Information we have: Temperature in degrees Fahrenheit = 67°F .	
$^\circ\text{C} = (67^\circ - 32^\circ) \div 1,8$	Replace $^\circ\text{F}$ with 67° in the formula: $^\circ\text{C} = (^\circ\text{F} - 32^\circ) \div 1,8$.
$^\circ\text{C} = 35^\circ \div 1,8$	Remember the order of operations: Calculate the brackets first and then do the division.
$^\circ\text{C} = 19,444 \dots^\circ$	Round off to two decimal places.
Temperature in degrees Celsius = $19,44^\circ\text{C}$	Look at the number in the third decimal place. It is less than 5, so round the second decimal place down.

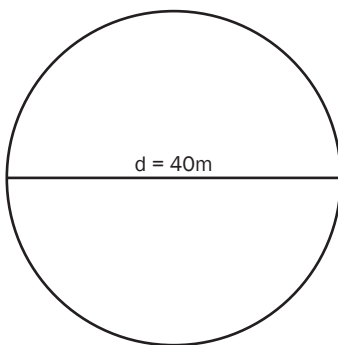

Worked example 7

A circular piece of land has a diameter of 40 m. What is the area of the land? Use the formula: $A = \pi r^2$ for the area of a circle and use the value of 3,142 for π .

Need to find: Area	Notes
Information we have: diameter = 40 m; $\pi = 3,142$	 Always make sure you use the quantity that is written in the formula – radius, not diameter.
But we need the radius, which is half of the diameter, so $r = 20 \text{ m}$.	
$A = \pi r^2$	
$A = 3,142 \times (20)^2$	$A = \pi r^2$ means Area = pi times the radius squared.
$A = 3,142 \times (20 \times 20)$ $A = 3,142 \times 400$	
$A = 1\,256,8 \text{ m}^2$	Are the units right? Yes, the diameter was given in metres, so the area will be in square metres (m^2).



Worked example 8

When we work with a formula, we want the quantity that we are calculating on its own on one side of the formula, so that it is the subject of the formula.

We can work out area easily if the formula is $\text{Area} = \text{length} \times \text{breadth}$. Now let's use the same formula to find the length.

Step 1	Look at the formula. Which is the quantity that you want to calculate?	$\text{Area} = \text{length} \times \text{breadth}$
Step 2	What do you need to do to get length on its own? Length is multiplied by breadth. We need to divide by breadth to leave length on its own.  You can only do something to a formula if you do the same to both sides!	
Step 3	Divide both sides by breadth:	$\text{Area} \div \text{breadth} = \text{length} \times \text{breadth} \div \text{breadth}$
Step 4	Now simplify the formula: $\text{area} \div \text{breadth}$	$= \text{length}$ (because: $\text{breadth} \div \text{breadth} = 1$)
Step 5	Length =	$\text{area} \div \text{breadth}$
Step 6	Use the formula to solve the problem by substituting the values for area and breadth.	



Worked example 9

To calculate the profit made from selling an item, we use the formula:

$\text{profit} = \text{selling price} - \text{cost price}$.

But what if we already know the profit and the cost price, but we need to calculate the selling price?

An example: It costs R121 to buy a necklace at cost price, and Thabo wants to make R65 profit. How much must he sell it for? (What is the selling price?)

		Selling price
Step 1	Look at the formula. Which is the quantity that you want to calculate?	$\text{profit} = \text{selling price} - \text{cost price}$ $P = SP - CP$
Step 2	Substitute the values that you have i.e. profit and cost price.	$R65 = SP - R121$
Step 3	Add cost price to both sides.	$R65 + R121 = SP - R121 + R121$
Step 4	Now simplify.	$R186 = SP$ (because $\text{cost price} - \text{cost price} = 0$)

Worked example 10

This example has a fraction in it. See what you need to do in that case to make a quantity the subject of the formula.

5 miles is approximately the same as 8 kilometres. The formula to convert kilometres to miles is:

$$\text{number of miles} = \frac{5}{8} \times \text{number of kilometres.}$$

Gavin has cycled 30 miles and he wants to know what this is in kilometres. The formula must start with “number of kilometres = ...”

Rearrange the formula. Then work out how many kilometres he has cycled.

Step 1	Look at the formula. Which is the quantity that you want to calculate?	number of miles = $\frac{5}{8} \times$ number of kilometres
Step 2	Number of kilometres is multiplied by $\frac{5}{8}$. So we need to multiply by $\frac{8}{5}$ because $\frac{5}{8} \times \frac{8}{5} = 1$.	
Step 3	Multiply both sides by $\frac{8}{5}$.	number of miles $\times \frac{8}{5} = \frac{5}{8} \times$ number of kilometres $\times \frac{8}{5}$
Step 4	Now simplify the formula: Move the “ $\times \frac{8}{5}$ ”.	number of miles $\times \frac{8}{5} = \frac{5}{8} \times \frac{8}{5} \times$ number of kilometres
	Cancel out: $\frac{5}{8} \times \frac{8}{5} = 1$.	number of miles $\times \frac{8}{5} =$ number of kilometres
Step 5	Now we have number of kilometres = number of miles $\times \frac{8}{5}$	
Step 6	Use the formula to solve the problem. You can do this in your head: $30 \times 8 = 240$ $240 \div 5 = 48$ Or use a calculator: 30 [\times] 8 [\div] 5 [=]	number of kilometres = number of miles $\times \frac{8}{5}$ number of kilometres = $30 \times \frac{8}{5} = 48$ km Gavin cycled 48 km.



Worked example 11

Thami needs to make a circle with an area of 40 cm^2 . What should the radius of the circle be? Round off your answer to two decimal places.

The formula for the area of a circle is $A = \pi r^2$. Use the value of 3,142 for π .

Step 1	Look at the formula. Which is the quantity that you want to calculate?	$A = \pi r^2$
Step 2	What do you need to do to get radius on its own on one side of the equation? There are two things: <ul style="list-style-type: none"> • radius is first squared • then it is multiplied by pi (π) 	
Step 3	Divide both sides by π	$Area \div \pi = \pi r^2 \div \pi$
Step 4	When then have Which we write as:	$Area \div \pi = r^2$ $\frac{area}{\pi} = r^2$
	Now take the square root of both sides.	$\sqrt{\frac{Area}{\pi}} = \sqrt{r^2}$
Step 5	Now we have $r = \sqrt{\frac{Area}{\pi}}$	
Step 6	Use the formula to solve the problem, by substituting the given values. To do this on your calculator: first enter $40 \div 3,142 =$ then press $\sqrt{\quad}$ Round off to two decimal places	$r = \sqrt{\frac{Area}{\pi}}$ $r = \sqrt{\frac{40}{3,142}} = 3,568 \dots$ $r = 3,57 \text{ cm}$ She needs to make the circle with a radius of 3,57 cm.

3. Statistics

You should know the following terminology:

Dependent variable: The thing that comes out of an experiment, the effect; the results.

Independent variable(s): The things that act as input to the experiment, the *potential* causes. Also called the *controlled* variable.

Control variable: A variable that is held constant in order to discover the relationship between two other variables. “Control variable” must not be confused with “controlled variable”.

Correlation does not mean causation. That is, if two variables seem to relate to each other (they seem to co-relate), it doesn’t mean that one causes the other. A variable only *causes* another variable if one of the variables is a function $f(x)$ of the other. We will see more about this when we look at graphs, below.

Mean: The average. In the series 1, 3, 5, 7, 9, the mean is $1 + 3 + 5 + 7 + 9$ divided by 5, since there are 5 bits of data. The mean in this case is 5.

Median: The datum (single bit of data) in the precise middle of a range of data. In the series 1, 3, 5, 7, 9, the median value is 5.

Mode: The most common piece of data. In the series 1, 1, 2, 2, 3, 3, 3, 4, 5, the mode is 3.

4. Triangles

The area of a triangle is half the base times the height: $A = \frac{b}{2}(h)$. A triangle with a base of 5 cm and a height of 3 cm will have an area of $2,5 \times 3 = 7,5 \text{ cm}^2$.

$$A = 7,5$$

b Base

5

h_b Height

3

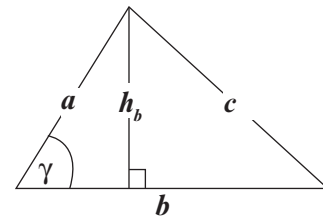

Lengths of Triangle Sides

You can calculate the lengths of sides of right-angled triangles using Pythagoras' Theorem. The square of the hypotenuse is equal to the sum of the squares of the other two sides: In this diagram, b = base, h_b = height, and c = the hypotenuse: $c^2 = h_b^2 + b^2$.

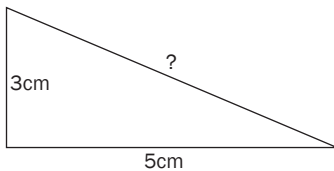

Worked example 12

In the triangle shown, the hypotenuse, marked "?", can be obtained by squaring both sides, adding them, and then square-rooting them for the length of the hypotenuse. That is: $3^2 + 5^2 = 9 + 25 = 34$. Since in this case $34 = \text{hyp}^2$ it follows that the square root of 34 gives the value of "?", the hypotenuse. That is, 5,83cm.

5. Graphs

It's probably best to start from scratch with Cartesian Coordinates.

"Coordinates" are numbers that refer to the distance of a point along a line, or on a surface, or in space, from a central point called the "origin". Graphs that you will use have only two dimensions (directions). The positions of points on these graphs are described using two coordinates: how far across (left-to-right) the point is, called the x -coordinate, and how far up-or-down on the page the point is, called the y -coordinate.



Worked example 13

Consider the following graph. It shows six points in a straight line.

The coordinates shown can be described using what are called “ordered pairs”. For example, the furthest point in this graph is 3 units across on the “ x -axis” or horizontal line. Likewise, it is also 3 units up on the y -axis, or vertical (up and down) line. So, its coordinates are (3;3). The point just below the midpoint or “origin”, is one unit down of the x -axis, and one unit left of the y -axis. So its coordinates are (-1;-1). Note that anything to the left or below of the origin (the circle in the middle), takes a minus sign.

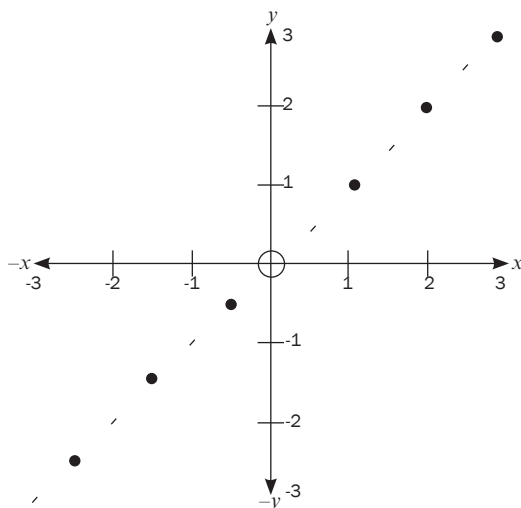

This series of dots look like they’re related to each other, because they’re falling on a straight line. If you see a result like this in an experimental situation, it usually means that you can predict what the next dot will be, namely, (4;4). This kind of prediction is called “extrapolation”. If you carry out the experiment, and find that the result is (4;4), and then (5;5), you’ve established that there is a strong relation or correlation.

Now, another way of saying that x relates to y , or x is proportional to y , is to say that y is a function of x . This is written $y = f(x)$. So, in the example given above, voltage is a function of resistance. But how is y related to x in this graph? Well, it seems to be in a 1 to 1 ratio: $y = x$. So the formula for this graph is $y = x$. In this case, we’re only dealing with two factors; $y = x$ and y .

6. Circles

- Diameter is the width of a circle ($2r$); radius is half the diameter ($d/2$). The edge of a circle is called the “circumference”. “Diameter” means to “measure across”. Compare “diagonal” which means an *angle across* a square or rectangle, so “dia-” means “across” (Greek). “Circumference” means to “carry in a circle” (Latin); think of how the earth carries us in a circle or orbit around the sun. To remember the difference between these things, just remember that the sun’s rays radiate out from the sun in every direction, so the radius is the distance from the centre of a circle, e.g. the sun, to the outer edge of a circle surrounding it, e.g. earth’s orbit (the circumference).
- Area of a circle = πr^2
- Circumference = $2 \pi r$
- You can use the above to solve for radius or diameter.

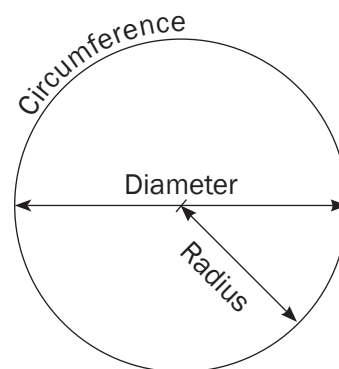

7. Reading Tables

7.1 Reading Tables

A table is a way of showing information in rows and columns.

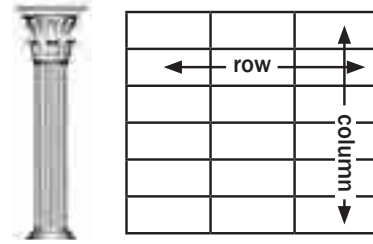

Getting information from tables

Reading a table means finding information in the cells. Each block in a table is called a cell. Reading a table is like reading a grid.

Look at the table on the right.

	A	B
1.		
2.		
3.		
4.		
5.		

A and B are the column headings.

1, 2, 3, 4, and 5 are the row headings.

- What is in A2? Go across to column A and read down to row 2. A bell.
- What is in B3? A hand.
- Give the row and column for the star. Row 4 and column A. You can also write A4.
- Give the row and column for the clock. Row 5 and column B. You can also write B5.



Worked example 14

Look at the table below. In a question, you might have to find information in the table and write it down, or you might have to use the information in the table to do a calculation.

The table below shows the average maximum and minimum temperatures (highs and lows) in Mauritius (measured in degrees Celsius) each month.

Average monthly maximum and minimum temperatures in Mauritius

Month of the year	Average maximum temperature °C	Average minimum temperature °C
January	35	24
February	30	22
March	30	21
April	29	21
May	25	19
June	24	17
July	26	18
August	27	19
September	29	20
October	32	22
November	32	22
December	34	24



This shows that in April the average maximum temperature was 29 °C. This shows that in November the average minimum temperature was 22 °C.



The table doesn't have units in the cells, but we know the units because they are in the headings for each column. Always give the units in your answer.

Look at the table above to answer these questions.

- Which month of the year had the highest average maximum temperature in Mauritius?
- Which month had the lowest average maximum temperature?
- What is the difference between the average maximum temperature in December and the average minimum temperature in December?

Solution

- Reading down the average maximum temperature column, you can see that January has a temperature of 35 °C, and none of the other temperatures are higher.
- The lowest maximum temperature is 24 °C in June.
- Here you will need to find the row for December and look across to get the lowest and highest temperatures for that month, then subtract the lowest temperature from the highest temperature to find the difference: $34 - 24 = 10^{\circ}\text{C}$.



Be careful! Here we are still working with the **average maximum temperature** column.



The difference between the lowest and highest numbers is called the **range**.



Worked example 15

The average monthly increases in the cost of electricity (excluding VAT) between 2011 and 2012

	Electricity consumption in kWh			
	50	150	600	1 000
Amount payable in 2011	R27,35	R85,83	R393,67	R728,63
Amount payable in 2012	R28,83	R94,99	R467,43	R888,83
Increase between 2011 and 2012	R1,48	R9,16	R73,67	R160,20
Percentage increase between 2011 and 2012	5,39%	10,67%	18,74%	21,99%

Read from the table to answer the questions.

- If a household used 600 kWh of electricity in 2011, what would they have paid?
- How much more would you pay for 1 000 kWh of electricity in 2012 compared to 2011?
- What was the percentage increase for 150 kWh of electricity between 2011 and 2012?
- Was the percentage increase higher for lower electricity consumption, or for higher electricity consumption?

Solution

When you answer a question like this, take a few minutes to look at the table and write down some notes about what it shows. Don't get too detailed, just to understand what the table is showing.

The columns show 4 different amounts of electricity consumption. The unit is kWh.

	Electricity consumption in kWh			
	50	150	600	1 000
Amount payable in 2011	R27,35	R85,85	R393,67	R728,63
Amount payable in 2012	R28,83	R94,99	R467,43	R8883,83
Increase between 2011 and 2012	R1,48	R9,16	R73,67	R160,20
Percentage increase between 2011 and 2012	5,39%	10,67%	18,74%	21,99%

First row shows the cost for 2011 and 2nd row shows 2012. This is what the table is comparing.

These amounts are calculated for us! These are differences between 2011 and 2012: Amount and Percentage.



The question is asking for the increase in the amount of money. So we are interested in the third row. The consumption is 1 000 kWh, so look at the 4th column and third row: R160,20.

Notice that there is an increase in costs this way. →

- a) Read off the 2011 row showing the amount, and the 600 kWh column: R393,67.
- b) You don't have to calculate; this difference is given in the third row.
- c) The percentage increase is given in the last row. So look at the last row and second column (for 150 kWh): 10,67%.
- d) In the fourth row, there is a steady increase in the percentages from lower to higher electricity consumption. So the percentage increase is bigger for higher consumption.



These numbers are for the same group of learners.

7.2 Reading Two-Way Tables

Two-way tables are a useful way to display information, and they help you to work out missing information.

These tables show the numbers of two categories for the same sample. One category is shown in rows, and the other category is shown in columns.

For example, the table below shows how many Grade 12 learners in a school own a cell phone or not and how many of the same learners own a music player or not.

	Own an MP3 player	Do not own an MP3 player
Own a cell phone	57	21
Do not own a cell phone	13	9

What's interesting about this table is that the totals of both columns and the totals of both rows are the same. We can see that the sample was of 100 learners.

	Own an MP3 player	Do not own an MP3 player	Total
Own a cell phone	57	21	78
Do not own a cell phone	13	9	22
Total	70	30	100



Worked example 16

During one month, 75 of the 180 babies born in a hospital were boys, and 40 of the babies weighed 4 kg or more. There were 26 baby boys who weighed 4 kg or more.

- Put this information in a two-way table and fill in the missing numbers.
- What percentage of girl babies weighed 4 kg or more?

Solution

- First draw up the grid and fill in the information given. (It doesn't matter whether you put the weights or the gender in the columns or rows.)

	Boys	Girls	Total
Weighed less than 4 kg			
Weighed 4 kg or more	26	0	40
Total	75		180

When you've got the table in this form, you can find the missing information. Work back from the totals. For example, if 26 of the baby boys weighed 4 kg or more, then $75 - 26 = 49$ of them weighed less than 4 kg.

	Boys	Girls	Total
Weighed less than 4 kg	49	91	140
Weighed 4 kg or more	26	14	40
Total	75	105	180

- There were 14 girl babies who weighed 4 kg or more, out of a total of 105 girl babies.

$$\frac{14}{105} \times 100\% = 13,33\%$$



Worked example 17

One hundred passengers on a bus trip were asked whether they wanted chicken or beef and whether they preferred rice or potato for their meals. Out of 30 passengers who liked rice, 20 liked chicken. There were 60 passengers who chose chicken.

- Put this information in a two-way table and fill in the missing numbers.
- How many meals with beef and potato should the bus company produce?

Solution

- Here is the information we are given:

	Chicken	Beef	Total
Rice	20		
Potato			
Total	60		

- Here is the rest of the information:

	Chicken	Beef	Total
Rice	20	10	30
Potato	40	30	70
Total	60	40	100

Numbers and calculations with numbers

1.1 Using a calculator

Basic calculators have a layout of keys similar to this:

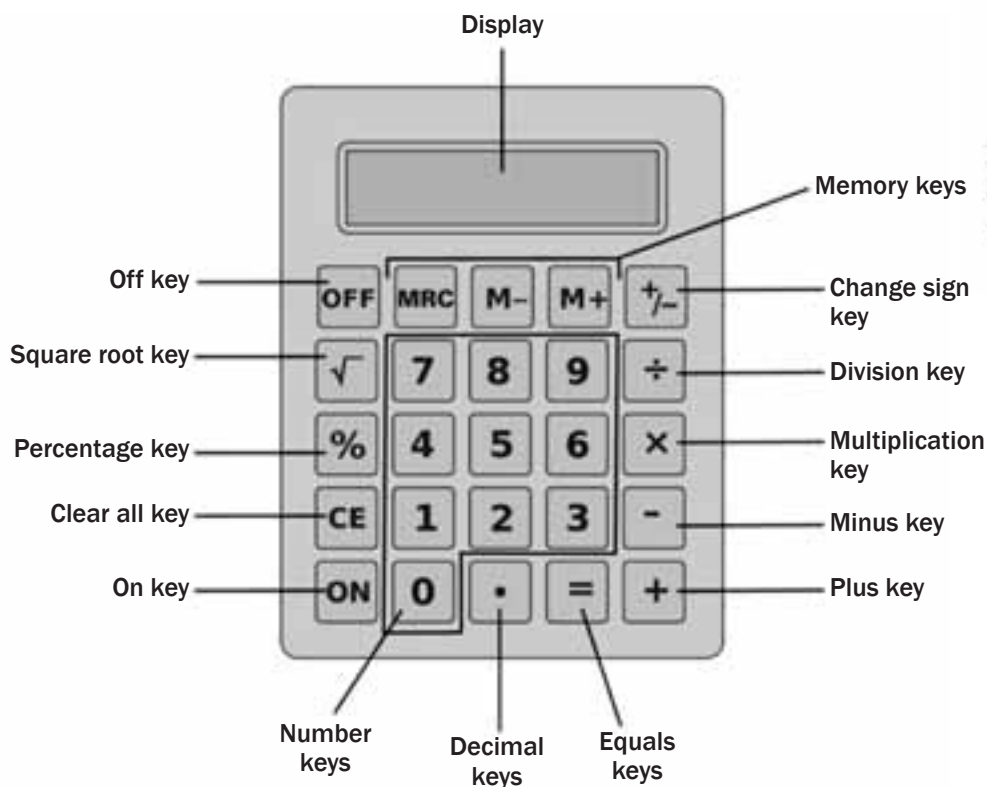

Identify all of these keys on your own calculator. The basic operations are +, -, x and \div . The more advanced functions are $\sqrt{\quad}$, % and [+/-].



Note: Large numbers can look different on a calculator display, e.g. 24 900 can look like this:

24900 or 24'900.

Changing the sign of numbers

Practise changing the sign of a number on your calculator. For example, change

100 to -100 . Calculators usually have a [+/-] key, which changes the sign of a number.

Checking your calculations

Sometimes you may press the wrong button on a calculator and get the wrong answer.

If you estimate quickly before doing the calculation, you may realise your answer is wrong, and then you can do the calculation again. It is easier to pick up a big mistake than a small one, e.g. you will notice a difference if you enter 67 instead of 657.

Always do a calculation twice. If the two answers are different, you need to do it again. This is especially useful when you are adding long lists of numbers.

Estimating means you make a rough calculation. It doesn't mean you are guessing. An easy way to estimate is to round off the numbers and then do the simpler calculation.

In this case, you don't have to round off to a certain digit. You can decide what number to round off to by looking at the calculation.

We will revise rounding off in Section 1.6.



When you divide, you sometimes need to round off to the closest numbers that are easier to divide.



Worked example 1

Estimate and then calculate:

- a) $467 - 93$
b) $6\ 808 \div 74$

Solutions

- a) $467 - 93$

Estimate: $500 - 100 = 400$

Round off both numbers to the nearest 100.

Calculate: $467 - 93 = 374$

374 is reasonably close to 400.

- b) $6\ 808 \div 74$

Estimate: $7\ 000 \div 70 = 100$

Calculate: $6\ 808 \div 74 = 92$

BODMAS

If there are no brackets in a calculation, we use the BODMAS rule to remember in which order we must do the operations. This is a rule for the correct order:

B	→	Brackets ()
O	→	Of or orders: powers, roots, etc.
D	}	→ Division and multiplication
M		
A	}	→ Addition and subtraction
S		

e.g. Worked example 2

$$40\ 000 - 2\ 000 \times 3 = 34\ 000.$$

You must first multiply 2 000 by 3 and then subtract the answer from 40 000. There is no other way to do this calculation.

If there are brackets, first do the operation in the brackets; then do the multiplication or division (from left to right); and last, do the addition or subtraction (from left to right).

e.g. Worked example 3

Kepa wrote this formula to show the cost of some clothes that he bought:

$$\text{Cost} = 4 + (\text{R}160 + 5) \times \text{R}85.$$

Work this out using the correct order of operations.

Solution

$$\begin{aligned} \text{Cost} &= 4 + (\text{R}160 + 5) \times \text{R}85 \\ &= 4 + 14\ 025 \\ &= \text{R}14\ 029 \end{aligned}$$



Remember BODMAS at all times. Don't let it trip you up!

e.g. Worked example 4

Work out $(80 - 40 + 8) \div 4 \times 2$

Solution

$$\begin{aligned} &(80 - 40 + 8) \div 4 \times 2 \\ &= (40 + 8) \div 4 \times 2 \\ &= 48 \div 4 \times 2 \\ &= 12 \times 2 \\ &= 24 \end{aligned}$$

1.2 Common fractions

A fraction is a measure of how something is divided into parts.



The fraction $\frac{5}{6}$ means five parts out of a total of six parts, where the whole is divided into 6 parts.

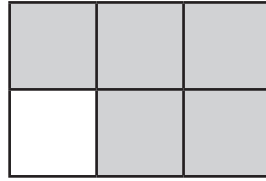

$\frac{5}{6}$ → numerator

6 → denominator

- This is called a common fraction. The numerator and the denominator are both whole numbers and they are separated by a line that represents division.
- Common fractions are called proper fractions when the numerator is smaller than the denominator, e.g. $\frac{2}{10}$ or $\frac{3}{5}$.
- When the numerator is bigger than the denominator, the fraction is called an improper fraction, e.g. $\frac{5}{2}$ or $\frac{7}{4}$.
- When we convert improper fractions to whole numbers with a fraction they are called mixed numbers, e.g. $\frac{9}{2} = 4\frac{1}{2}$ and $\frac{4}{3} = 1\frac{1}{3}$.

1.3 Decimals



Therefore the decimal fraction is a fraction where the denominator is a power of ten.

What is a decimal fraction?

Think back to place value: Thousands; Hundreds; Tens and Units.

$1\ 000 \div 10 = 100$
$100 \div 10 = 10$
$10 \div 10 = 1$
$1 \div 10 = 0,1$

The number 0,1 is equal to $\frac{1}{10}$. This is how a basic calculator shows one tenth.

The bar below is divided into ten equal parts; 1 is divided into 10.



We have found that $1 \div 10 = 0,1$.

Think back to fractions:

$1 \div 2 = 0,5$

So $1 \div 10 = 0,1$

0,1 is just another way of writing $\frac{1}{10}$.

Place value

The value of a digit depends on its place in a number. For example, in 808,713 kg the first 8 is 800 kg and the second 8 is 8 kg.

Hundreds	Tens	Units	tenths	hundredths	thousandths
8	0	8	7	1	3

Every digit has a place value $10\times$ more than the digit on its right.

e.g. Worked example 5

a) Write these numbers in a place value table.

Hundreds	Tens	Units	tenths	hundredths	thousandths

(i) 30,44

(ii) 302,404

Solution

Hundreds	Tens	Units	tenths	hundredths	thousandths
	3	0	4	4	
3	0	2	4	0	4



Another trick to keep in mind is how we multiply numbers by 10, 100 and 1 000.

- To multiply by **10**, every digit moves to the left by **one** decimal place, OR the decimal comma moves to the right **once**.
- To multiply by **100**, every digit moves to the left by **two** decimal places, OR the comma moves to the right **twice**.
- To multiply by **1 000**, every digit moves to the left by **three** decimal places, OR the comma moves to the right **three** times.

It is useful to do these calculations in a place value table, or in columns.

e.g. Worked example 6

Look at the example in the place value table below. We multiply the number 287,5 by 10, then 100 and then 1 000.

HTh	TTh	Th	H	T	U	t	h	
			2	8	7	5		
		2	8	7	5			$\times 10$
	2	8	7	5	0			$\times 100$
2	8	7	5	0	0			$\times 1\,000$

1.4 Percentages

To solve a percent problem, first identify the three parts in the calculation. Two of the parts should be given, and you need to calculate the third part.

Types of percent problems

1. Find the unknown amount. \rightarrow $\overset{\text{(given)}}{\text{percent}} \times \overset{\text{(given)}}{\text{whole}} = \overset{\text{(unknown)}}{\text{new amount}}$

2. Find the unknown percent. \rightarrow $\overset{\text{(unknown)}}{\text{percent}} \times \overset{\text{(given)}}{\text{whole}} = \overset{\text{(given)}}{\text{new amount}}$

3. Find the unknown "whole". \rightarrow $\overset{\text{(given)}}{\text{percent}} \times \overset{\text{(unknown)}}{\text{whole}} = \overset{\text{(given)}}{\text{new amount}}$

7. Percentage increase or decrease. \rightarrow $\overset{\text{(given)}}{\text{percent}} \times \overset{\text{(given)}}{\text{whole}} = \overset{\text{(unknown)}}{\text{new amount}}$
 $\text{whole} - \text{new amount} = \text{final amount}$
 $\overset{\text{(given)}}{\text{percent}} \quad \overset{\text{(calculated)}}{\text{new amount}} \quad \overset{\text{(unknown)}}{\text{final amount}}$
OR
One step:
 $\text{whole} - \% \text{ of whole} = \text{final amount}$

Some calculators work differently. Check your own calculator and make sure you know the correct key sequences to use.



Type 1: Find the unknown amount

If you know the whole and the percent, you need to find the unknown amount.

NOTE:

The rule: Percent \times whole = new amount

e.g. Worked example 7

What is 18% of 300?

Solution

Write the equation: $18\% \times 300 = \text{new amount}$
 $\frac{18}{100} \times 300 = \text{new amount}$
 $54 = \text{new amount}$



Remember: "of" means "multiply".

Type 2: Find the unknown percent

1. If the amount is less than the whole, the percent will be less than 100%.
2. If the amount is greater than the whole, the percent will be greater than 100%.



Worked example 8

A group of 30 out of 150 learners represents the Grade 12s in athletics. What percentage is this?

Solution

We know the amount, 30, and the whole, 150. The percent is the unknown.

Write an equation: percent \times whole = amount

$$\frac{30}{150} = 0,2 \times 100 \text{ percent}$$

Divide both sides by 150: percent = 20%

Type 3: Find the unknown whole



Worked example 9

You get 40% for a test, or a mark of 28. What is the total number of marks for the test?

Solution

We know the amount, 28, and the percent, 40%. The whole (total marks) is the unknown.

Write an equation: percent \times whole = amount

$$40\% \times \text{whole} = 28$$

$$\frac{40}{100} \times \text{whole} = 28$$

$$0,4 \times \text{whole} = 28$$

Divide both sides by 0.4: whole = $\frac{28}{0,4}$

$$\text{whole} = 70$$

28 marks is 40% of 70 marks.

The total for the test is 70 marks.

Type 4: Percentage increase or decrease

These kinds of problems combine ordinary percent problems with final addition or subtraction.

RULE:

$$\text{new amount} = \text{whole} + (\text{percentage} \times \text{whole})$$

Percentage added to an amount (Percentage increase)

Percentage increase on a price means the normal price plus the increase.



Worked example 10

The price of petrol increases by 12%. The original price was R10,70 per litre. What is the new petrol price?

Method 1

New price = old price + 12% of old price

$$\begin{aligned} \text{New price} &= \text{R}10,70 + 12\% \times \text{R}10,70 \\ &= \text{R}10,70 + 0,12 \times \text{R}10,70 \\ &= \text{R}10,70 + \text{R}1,284 \\ &= \text{R}11,984 \\ &\text{which is R}11,98 \end{aligned}$$

Method 2

New price = old price + 12% of old price

$$\begin{aligned} &= 112\% \text{ of old price} \\ &= 1,12 \times \text{old price} \\ &= 1,12 \times \text{R}10,70 = \text{R}11,98 \end{aligned}$$

Always round off money to the nearest cent.



Worked example 11

Nomalizo receives a salary increase of 7%. If her new salary is R10 600, what was her salary before the increase?

New salary = original salary + 7% of original salary

$$\text{R}10\ 600 = (100\% + 7\%) \text{ of original salary}$$

$$\text{R}10\ 600 = 107\% \times (\text{original salary})$$

$$\frac{\text{R}10\ 600}{107\%} = \text{original salary}$$

So the original salary is R9 907.

Percentage taken away from an amount (Percentage decrease)

Percentage decrease on a price means the normal price less the decrease.

RULE:

$$\text{new amount} = \text{whole} - (\text{percentage} \times \text{whole})$$



Worked example 12

A pair of jeans is on sale with a mark down of 20%. If the original price of the jeans was R199,00, what is the sale price?

Method 1

$$\begin{aligned} \text{Discount} &= 20\% \times \text{R}199 \\ &= 0,2 \times \text{R}199 \\ &= \text{R}39,80 \end{aligned}$$

The sale price = original price – discount
 = R199 – R39,80
 = R159,20

Method 2

Sale price is normal price less 20%, so sale price is 80% of normal price.

Sale price = 80% of R199
 = $0,8 \times R199$
 = R159,20

In the exam, you won't be told which calculation you must do. You have to read the question carefully. Let's see how to do this.

**Working with VAT**

All prices that we see in shops include VAT (Value Added Tax). You need to calculate VAT when:

- you are selling something and have to add VAT to the price
- you want to check an invoice and make sure that the correct amount of VAT is included
- VAT-inclusive: means that 14% VAT has already been added to the price
- VAT-exclusive price + amount of VAT = the price including VAT.

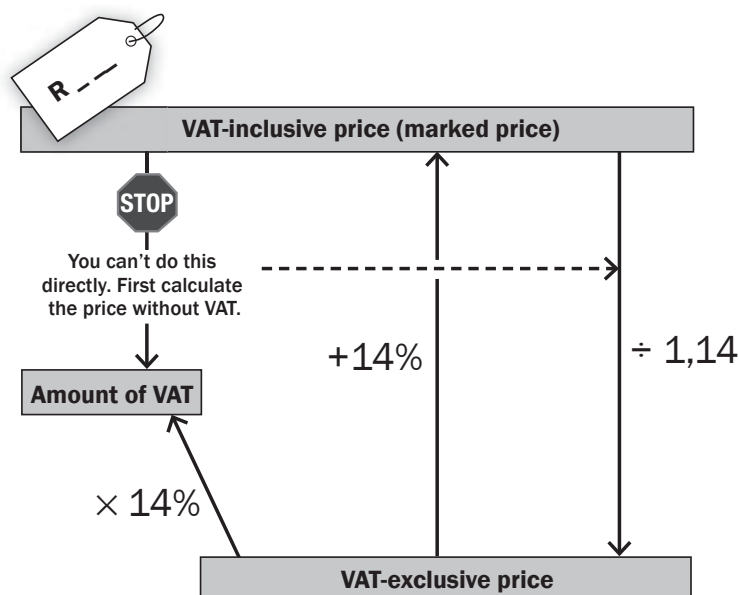
**Worked example 13**

The item costs R100. It includes 14% VAT.
 VAT was added to the original price.
 The original price + 14% VAT = R100.
 Original price + 14% × original price = R100
 Now think: original price is 100%, so:
 114% × original price = R100
 1,14 × original price = R100
 original price = $R100 \div 1,14$
 = R87,719

Write down three digits after the decimal comma from your calculator so that you can round off.

The original price was R87,72.

**Worked example 14**

The item costs R87,72 excluding 14% VAT.
 VAT must be added to the original price.
 Original price + 14% VAT = VAT-inclusive price
 114% × original price = VAT-inclusive price
 1,14 × original price = VAT-inclusive price
 The VAT-inclusive price is:
 1,14 × R87,72 = R100

1.5 Ratio, proportion and rate

1.5.1 Ratio

Ratios are used in many kinds of calculations and problems. Ratios compare values.

A ratio says how much of one thing is compared to another thing.

Here are 3 grey squares to 2 white squares:



$$3 : 2$$

$$3 \text{ to } 2$$

Ratios can be shown in different ways:

Use “:” to separate the values: $3 : 2$

Instead of “:” you can use the word “to”: $3 \text{ to } 2$

or write it as a fraction: $\frac{3}{2}$

Ratios can be scaled up or down:

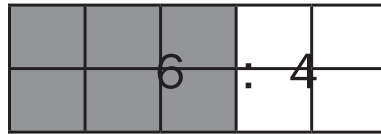

$$= 3 : 2$$

$$6 : 4 = 3 : 2$$

The ratio $6 : 4$ is the same as $3 : 2$, even though there are more squares in total.

The trick with ratios is to always multiply or divide both of the numbers by the same value.

$$\begin{array}{ccc} 3 & : & 2 \\ \times 2 & & \times 2 \\ \downarrow & & \downarrow \\ 6 & : & 4 \end{array}$$

$3 : 2$ is the same as $3 \times 2 : 2 \times 2 = 6 : 4$.

Writing ratios in the simplest form and equal ratios

You can write a ratio in its simplest form in the same way as you would write a fraction in its simplest form. Check if there is a number that divides into both numbers, starting with the smallest number in the ratio, and then checking with 2; 3; 5; etc. If there is none, then the ratio is already in its simplest form.

To check if ratios are equivalent write both of them in their simplest form, which will be exactly the same if they are equal. For example 5 : 10 and 30 : 60 are equivalent ratios because they both simplify to 1 : 2.



Worked example 15

A recipe for pancakes uses 3 cups of flour and 2 cups of milk. So the ratio of flour to milk is 3 : 2.

If you need to make pancakes for many people you might need 4 times the quantity, so you multiply both of the numbers by 4:

$$3 \times 4 : 2 \times 4 = 12 : 8$$

12 cups of flour and 8 cups of milk.

The ratio is still the same.



Always use the numbers in the same order;
3 cups of flour to 2 cups of milk is not the same as
2 cups of flour to 3 cups of milk.



Worked example 16

If there are 80 learners who travel by bus and 120 learners who travel by taxi, then we have a ratio of 80 (bus) to 120 (taxi). What is this ratio in its simplest form?

$$80 : 120$$

means the same as 8 : 12 (divide both numbers by 10)

which means the same as 2 : 3 (divide both numbers by 4)



Activity 1: Working with ratio

A company has a total of 150 employees and 25 of them are managers. What is the ratio of managers to non-managers?

- (A) 1 to 3
- (B) 1 to 4
- (C) 1 to 5
- (D) 1 to 6
- (E) 2 to 5

[5]

Solution

The company has 25 managers, so the remaining 125 employees are non-managers. Express this ratio as a fraction and then reduce it:

$$\frac{\text{Managers}}{\text{Non-managers}} = \frac{25}{125} = \frac{1}{5}$$

The ratio of managers to non-managers is 1 to 5, so the correct answer is Choice (C).

[5]

1.5.2 Ratios that compare 3 numbers

Sometimes 3 quantities are mixed together in a fixed ratio.

You work with these ratios in the same way.



Worked example 17

A grandmother wants to share R800 between her three grandchildren, in the ratio of their ages 20 years, 15 years and 5 years. How much should they each get?

Solution

Simplify the ratio 20: 15: 5
= 4: 3: 1

The total number of parts is 4 + 3 + 1 = 8

The shares are $\frac{4}{8} \times R800 = R400$

$$\frac{3}{8} \times R800 = R300$$

$$\frac{1}{8} \times R800 = R100$$

The shares add up to R800.

1.5.3 Different kinds of problems to solve with ratios

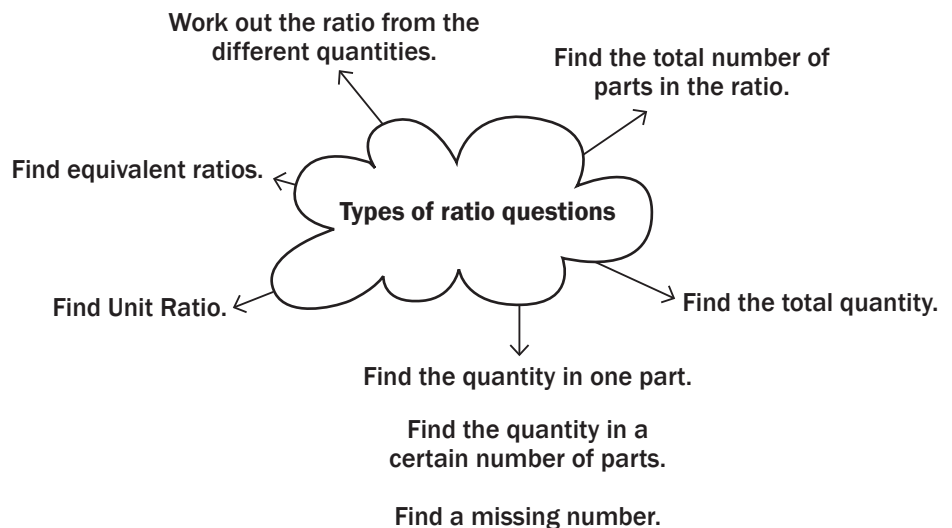

1.5.4 Writing ratios in unit form

Writing a ratio in the simplest form will sometimes result in one of the numbers being equal to 1. This is called a unit ratio. For example, the ratio of 5 roses to 15 daisies in a bunch of flowers is simplified to the unit ratio 1 : 3.

In some situations a unit ratio is not in the simplest form. For example, 5 : 9 can be written as 1 : 1,8, which is a unit ratio, but is not in the simplest form. To calculate the unit ratio, we simply divide both numbers by the smaller number, so $5 \div 5 : 9 \div 5 = 1 : 1,8$.

Let's look at some situations in which the unit ratio is useful.



Worked example 18

- a) There are 23 nurses in a hospital and 7 567 patients. How many patients does each nurse have to care for?
- b) In a Grade 10 class, learners are voting for a class badge. 4 learners vote for badge A and 17 vote for badge B. How many learners vote for badge B for each learner voting for badge A?

Solutions

$$\begin{aligned} \text{a)} \quad & 23 : 7\,567 \\ & = 1 : 329 \end{aligned}$$

Each nurse must care for 329 patients.

- b) Learners voting for badge B = 17 and learners voting for badge A = 4.

$$\begin{aligned} & 17 : 4 \\ & = 4,25 : 1 \end{aligned}$$

Approximately 5 learners vote for badge B for each learner who votes for badge A.

Proportions

A proportion is an **equation** with a ratio on each side. It is a statement that two ratios are equal.

$\frac{1}{20} = \frac{5}{100}$ is an example of a proportion.

When one of the four numbers in a proportion is unknown, we can cross-multiply to find the unknown number. We can use question marks, placeholders (\square) or letters in place of the unknown number.



Worked example 19

Sipho is making up bunches of flowers to sell at a flower shop. He is instructed to use three times as many daisies as roses in each bunch. So the ratio of roses to daisies is 1 : 3.

He has 15 daisies in one bunch. How many roses should he put in this bunch? We don't know how many flowers there are in the bunch altogether.

If you can't solve a proportion problem, making a table can help.



In a proportion you might see a variable x that stands for the unknown number, like $\frac{1}{3} = \frac{x}{15}$. Follow the same method to calculate what x stands for.



Solution

Write the problem as a proportion. Here is a proportion with ? standing for the unknown number:

$$1 : 3 = ? : 15$$

$$\text{Or } \frac{1}{3} = \frac{?}{15}$$

The ? represents the number of roses he should put in.

There are many ways to find the unknown value. We can use what we know about equivalent fractions to make $\frac{?}{15}$ the same as $\frac{1}{3}$. We need to multiply the denominator 3 by 5 to get the denominator 15, so we would also have to multiply the numerator 1 by 5. So we get the fraction $\frac{5}{15}$.

Another way to find the value of the unknown is to cross-multiply.

$$\frac{1}{3} = \frac{?}{15}$$

$$1 \times 15 = 3 \times ?$$

$$15 = 3 \times ?$$

We want to solve this equation by getting the unknown on its own on one side of the equation. So we divide both sides of the equation by 3 and we get:

$$5 = ?$$

This gives us the same answer.

So Siphu must use 5 roses and 15 daisies.

Notice that there are 20 flowers in this bunch. We did not need to use this fact to find the answer, because we knew the ratio and one number.

When we use ratio and proportion to solve problems, it is important to state very clearly which numbers represent which quantities. It can help to use tables for this.

In the example of the bunch of flowers above, we could have represented the information in a table like this:

Roses : daisies	1 : 3	? : 15
Number of roses	1	?
Number of daisies	3	15



Worked example 20

A summer camp has a boy-to-girl ratio of 8 : 11. If the camp has 88 boys, what is the total number of children in the camp?

- (A) 121
- (B) 128
- (C) 152
- (D) 176
- (E) 209

Solution

Begin by setting up the proportion as the following equation:

$$\frac{\text{Boys}}{\text{Girls}} = \frac{8}{11}$$

Before continuing, notice that the ratio specifically mentions boys first and girls second, so this order is maintained in the equation. The camp has 88 boys, so substitute this number for *Boys* in the equation. You don't know how many girls there are, so use the variable *g*. Here's what your equation now looks like:

$$\frac{88}{g} = \frac{8}{11}$$

To find out how many girls are in the camp, solve for *g* using algebra. First, cross-multiply to get rid of the two fractions:

$$88(11) = 8(g)$$

$$968 = 8g$$

Now divide both sides by 8:

$$121 = g$$

The camp has 121 girls and 88 boys, so you know it has a total of 209 children; therefore, the correct answer is Choice (E).

1.5.5 Rate

What is a rate?

A rate, like a ratio, also compares two numbers or measurements, but the two numbers in a rate have different units.

Some examples of rate include cost rates, (for example potatoes cost R16,95 per kg or 16,95 R/kg) and speed (for example, a car travels at 60 km/h).

When we calculate a rate, we divide by one of the values, so we are finding the amount per one unit, which is a unit rate.

One example of a unit rate is speed in km/h.

If a car's speed is 60 (km/h) kilometres per hour, then for every hour of driving, a distance of 60 km is covered.

If we want a unit cost rate for R20 for 2 kg of flour, we write:

$$R20 : 2 \text{ kg} = R10 : 1 \text{ kg}$$

$$= R10/\text{kg}.$$

This rate is a unit rate.

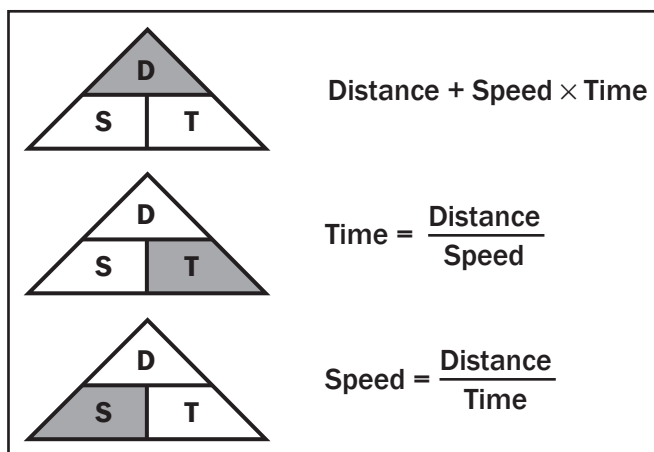

1.6 Rounding off according to the context

When we round off numbers, we need to be aware of the context of the problem. This will determine whether we round up or down.

When we round off to the nearest 10, we follow the simple rule that numbers with unit digits from 1 to 4 are rounded **down** to the lower ten, while numbers with units digits from 5 to 9 are rounded **up** to the higher ten.

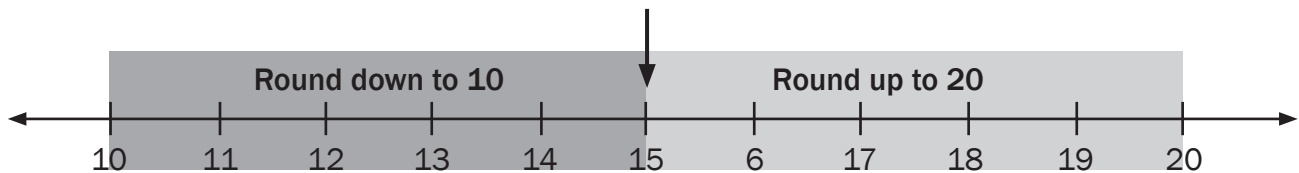

However, when we are working in some practical, real-life situations, we must think carefully about the effect of rounding off. In other words, the answer must be reasonable so that it is not only correct, but also makes sense in the situation.

For example, South Africa no longer has 1c and 2c coins, so shops need to round off the totals to a 5c value if customers are paying cash. Shops round down, rather than rounding up. So if your total is R13,69, you would pay R13,65 in cash. If you pay by credit or debit card however, the totals are not rounded off.



Worked example 21

Answer the following questions and in each case explain why you would round up or down to get a reasonable answer.

- a) Jacolene is catering for a group of 54 people. The muffins are sold in packs of 8. How many packs of muffins must she buy?
- b) A group of learners is going to the Maropeng Centre at the Cradle of Humankind. There are 232 learners and teachers going on the outing. The school needs to hire buses and each bus can carry 50 passengers.
- (a) How many buses should they hire?
- (b) How many empty seats will there be?
- c) Ludwe is buying blinds for a large window in his home. Each blind is 100 cm wide. The window is 260 cm wide. How many blinds does he need?

Solutions

a) Number of packs = $\frac{54}{8}$
= 6,75

She must buy 7 packs.

b) (a) Number of buses = $\frac{232}{50}$
= 4,64

The school will need 5 buses.

(b) Number of empty seats = $250 - 232$
= 18 empty seats

c) Number of blinds needed = $\frac{260}{100}$
= 2,6

He needs 3 blinds.

1.7 Squares and cubes of numbers

Squares of numbers

The square of a number is the number multiplied by itself.

4^2 means '4 squared' or 4×4 .

We can represent squares of numbers in diagrams. The number of blocks along one side of the square is the number that is being squared. The total number of small squares in each diagram is equal to the square of the number.

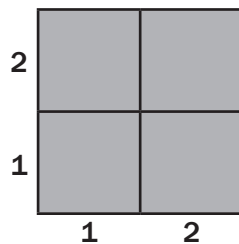

$$2^2 = 2 \times 2 = 4$$

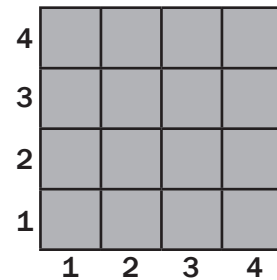

$$4^2 = 4 \times 4 = 16$$

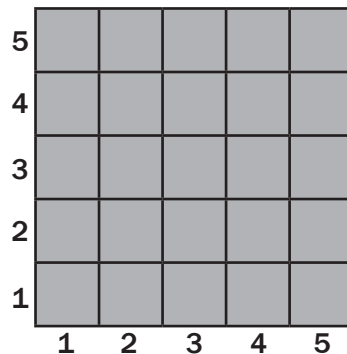

$$5^2 = 5 \times 5 = 25$$

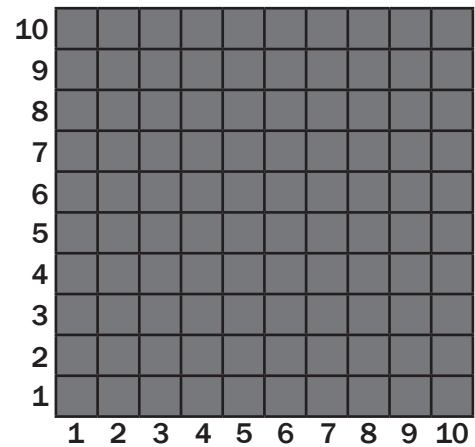

$$10^2 = 10 \times 10 = 100$$

You need to know how to square numbers in order to work with area.

Square roots

In each example above, the number that is squared is the square root of the answer. So the square root of 4^2 is equal to 4. We can write this as $\sqrt{16} = 4$. Similarly $\sqrt{25} = 5$, and $\sqrt{100} = 10$.

To work out square roots on your calculator: enter the number, and then use the square root key.

Finding the square root of a number is the same as finding the side of the square. It is the opposite of squaring the number.

Cubes of numbers

In the same way, a number to the power of three is called the cube of the number. So 3^3 is $3 \times 3 \times 3$, or 'three cubed' and is equal to 27. In the diagram below, the length of each side is the number that is cubed.

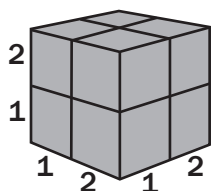

$$2^3 = 2 \times 2 \times 2 = 8$$

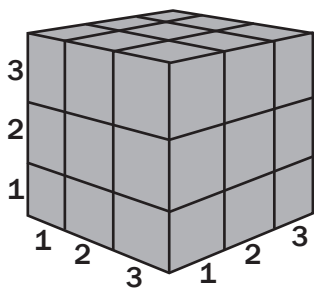

$$3^3 = 3 \times 3 \times 3 = 27$$

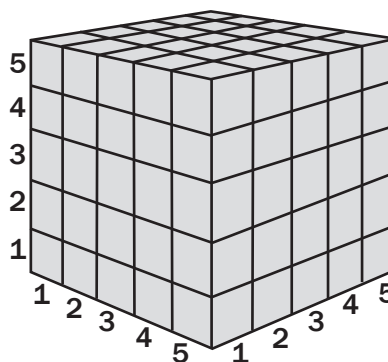

$$5^3 = 5 \times 5 \times 5 = 125$$

1.8 Time

Time values can be expressed in different formats, e.g. 8 o'clock, 8:00 a.m., 8:00 p.m. and 20:00. The two most common formats are the 12-hour format and the 24-hour format.

12-hour format: 8:00 a.m. and 8:00 p.m. are examples of readings of time using the 12-hour format. This format is seen on analogue clocks and watches. In the diagram below, the short hand shows us the hour and the long hand shows us the minutes. Sometimes a third hand shows the seconds.

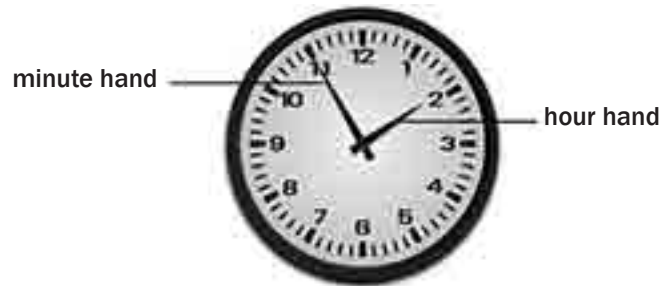

When we use the 12-hour clock, we use the letters “a.m.” to show that the time is before midday (12 o'clock or noon) and “p.m.” to show that it is after midday. For example, school may start at 7:30 a.m. (in the morning) and finish at 2 p.m. (in the afternoon).

24-hour format: 20:00 is an example of the 24-hour time format. This format is seen on digital watches, clocks and stopwatches. On digital clocks, the number on the left shows the hour and the number on the right shows the minutes. Some digital watches have a third, smaller number on the far right which shows seconds.

Sometimes we also speak of “hundred hours format”. In “hundred hours” time format, we replace the colon (:) with an “h”, so, 20:00 is written 20h00.



Worked example 22

- a) Write the following times in the 24-hour format.
- (i) Jane goes to bed at 9:56 p.m.
 - (ii) The local shop opens at 8:30 a.m.
 - (iii) Archie's cricket practice ends at 4:05 p.m.
- b) Write the following times in the 12-hour format.
- (i) David's school day ends at 14:45.
 - (ii) Mrs Gwayi has morning tea at 10:25.
 - (iii) The Dube family eats dinner at 19:35.

Solutions

- a) (i) $09:56 + 12 \text{ hours} = 21:56$
 (ii) 8:30 (This is before midday so it's written the same.)
 (iii) $4:05 \text{ p.m.} + 12 \text{ hours} = 16:05$
- b) (i) $14:45 - 12 \text{ hours} = 2:45 \text{ p.m.}$
 (ii) 10:25 a.m. (This is before midday so it's written the same.)
 (iii) $19:35 - 12 \text{ hours} = 7:35 \text{ p.m.}$

As with all the conversions we have already done, we use different units of time to measure different events. For example, you would measure the length of your school holidays in days or weeks, not seconds. But the time it takes to walk across a road would be measured in seconds, not years!

**Converting units of time**

The relationships between the units of time are given in the table below.

Time Conversions
60 seconds = 1 minute
60 minutes = 1 hour
24 hours = 1 day
7 days = 1 week
365 days = approximately 52 weeks = 12 months = 1 year

**Worked example 23**

- a) It takes John 140 seconds to boil water in a kettle. How many minutes and seconds does the water take to boil?
- b) A movie lasts 138 minutes. How long is the movie in hours and minutes?

Solutions

- a) 60 seconds = 1 minute
 Therefore $140 \text{ seconds} = \frac{140}{60} = 2,33 \dots$

From our answer of 2,33 we know that we have 2 whole minutes and some remainder in seconds.

We can now work backwards to calculate the remainder:

$$2 \text{ minutes} = 120 \text{ seconds}$$

$$140 \text{ seconds} - 120 \text{ seconds} = 20 \text{ seconds}$$

$$\text{So } 140 \text{ seconds} = 2 \text{ minutes and } 20 \text{ seconds. } (0,33 \dots \times 60 = 20 \text{ sec.})$$

- b) 60 minutes = 1 hour
 Therefore $138 \text{ minutes} = \frac{138}{60} = 2,3$. This does not mean 2 hours and 3 minutes!

We know that we have 2 whole hours and some remainder in minutes.

We now work backwards to calculate the remainder:

$$2 \text{ hours} = 120 \text{ minutes}$$

$$138 \text{ minutes} - 120 \text{ minutes} = 18 \text{ minutes}$$

$$\text{So } 138 \text{ minutes} = 2 \text{ hours and } 18 \text{ minutes. } (0,3 \times 60 = 18 \text{ minutes})$$

This does not mean 2 minutes 33 seconds!





Activity 2: Convert units of time

This does not mean 1 day and 417 hours!



1. A train journey takes 34 hours. How many days and hours does the journey take? (3)
2. A plane trip (with stopovers) from South Africa to China takes 38 hours. How many days and hours does the trip take? (1)

[4]

Solutions

1. 24 hours = 1 day

$$\text{Therefore } 34 \text{ hours} = \frac{34}{24} = 1,417. \checkmark$$

From our answer of 1,417 we know that we have 1 whole day and some remainder in hours. \checkmark

We now work backwards to calculate the remainder:

$$1 \text{ day} = 24 \text{ hours}$$

$$34 \text{ hours} - 24 \text{ hours} = 10 \text{ hours}$$

$$\text{So } 34 \text{ hours} = 1 \text{ day and } 10 \text{ hours. } (0,417 \times 24 \text{ hours} = 10 \text{ hours}) \checkmark$$

2. $38 - 24 = 14$

The trip takes 1 day and 14 hrs. \checkmark

[4]



Patterns and graphs

2.1 Making sense of graphs that tell a story

- A graph is a picture of the relationship between two quantities, such as distance and time. The advantage of a graph is that you can see the whole story at one time.
- This section gives you tools to analyse the information in the graph of a relationship. You will consider the following questions.

What does the graph look like?

Straight line, smooth curve, broken-line, separate points?

Is the graph increasing or decreasing or staying the same?
Or does it change?

What quantity does the horizontal axis show?

What quantity does the vertical axis show?

Where does the graph start on the vertical axis?
Does it go through (0:0)?

Does the graph change?
Where?

What is the highest point of the graph (maximum)?

What is the lowest point of the graph (minimum)?

2.2 Plotting points on a graph grid

An ordered pair gives us the exact position of a point on a grid. The first number in an ordered pair is the horizontal coordinate and the second number is the vertical coordinate. The order is very important. For example, if 5 apples cost R4, then we could write an ordered pair like this: (5, 4).

'Plotting points' means to mark positions on a grid, given ordered pairs.

Steps: To plot the point representing the ordered pair (5; 4):

1. Start at the zero point on the graph (0; 0).
2. Move **across** the horizontal axis to the right until you reach 5.
3. Then, move **upwards** until you are in line with 4 on the vertical axis.
4. Draw a dot or a cross where the grid lines cross. You have plotted the point (5; 4).

To plot a point,
always move
across then up.



5 apples cost R4. Plot the point.

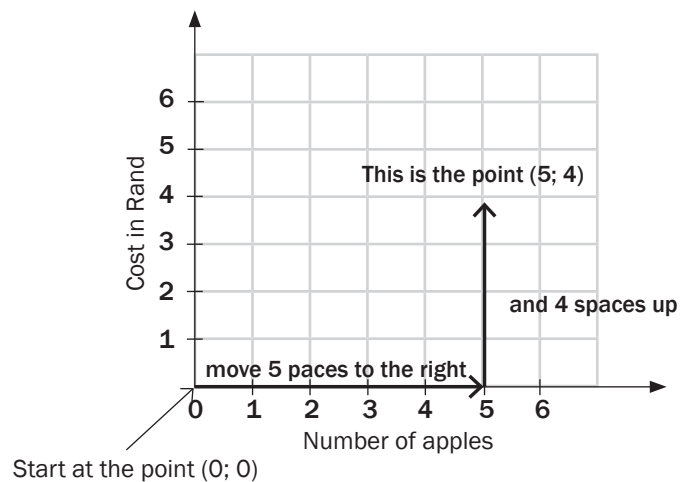

The line that runs left to right is called the horizontal or x -axis. The line that runs top to bottom is called the vertical or y -axis. The plural of axis is "axes", pronounced "akseez".

Ordered pair: Two numbers written in a particular order so that they give the location of a point on a grid.

Coordinate: A number in an ordered pair. The first coordinate shows the position along the horizontal axis, and the second coordinate shows the position up the vertical axis.

The **independent variable** is not changed by other factors, and we plot it on the horizontal axis.

The **dependent variable** has values that depend on the independent variable, and we plot it on the vertical axis.

2.3 Reading information from a graph

When you are given a graph, make some notes on it to help you understand it.

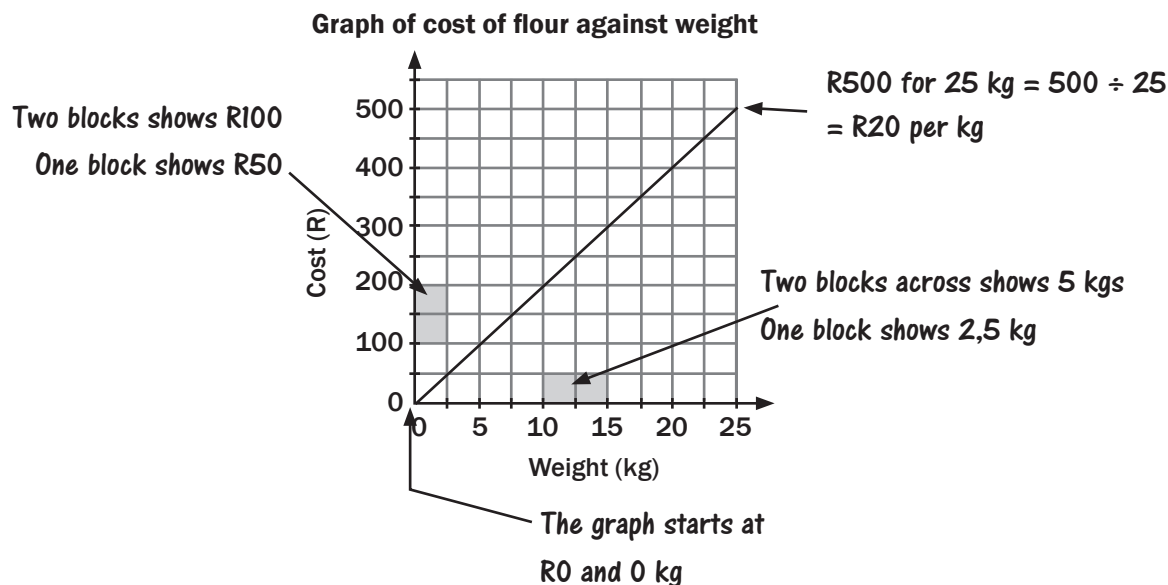

The two quantities are cost and weight of flour.

- The price increases as customers buy more flour.
- The graph starts at R0 for 0 kg and it shows R500 for 25 kg.
- Weight is the independent variable, and cost is the dependent variable.

2.4 Touching the axes

What does it mean when a graph touches the horizontal axis or the vertical axis?

- If the graph touches the vertical axis, it means that the quantity on the horizontal axis has reached 0.
- If a graph touches the horizontal axis, it means that the quantity on the vertical axis has reached 0.



Worked example 1

- Tumelo empties his 500 mℓ water bottle at a constant rate.
- Describe what you see in this graph.

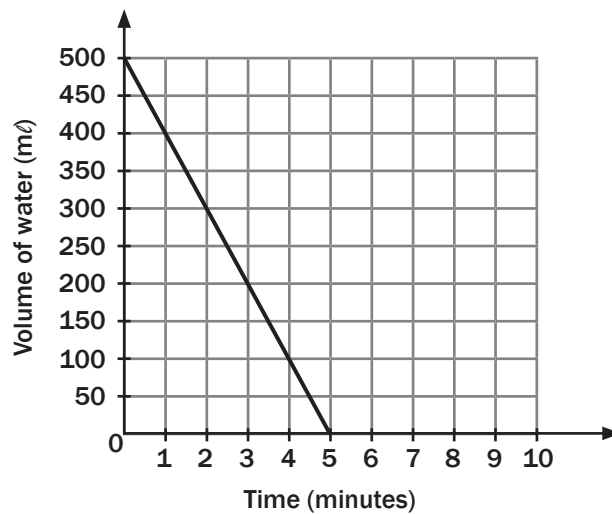

Solutions

- As time elapses, the volume of water decreases from 500 mℓ, until the bottle is empty at the end of the 5th minute.
- When $t = 0$, $v = 500$. When $t = 5$, $v = 0$.

2.5 Graphs going up (increasing) and going down (decreasing)

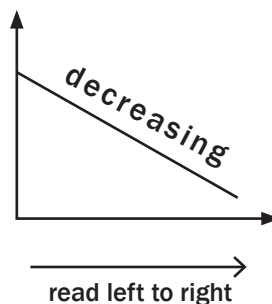
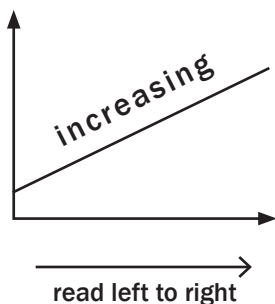

If a graph is increasing, the graph goes up from left to right.
If a graph is decreasing, the graph goes down from left to right.

How do we know if one line is steeper than another line? You can see the difference by looking at the slope or gradient.

A steeper slope shows a quicker rate of change. A gentle slope increases or decreases more slowly.

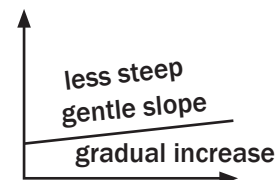
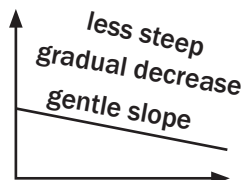
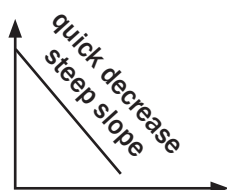
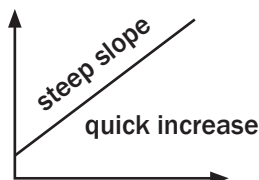

Put your finger on the graph and move along the graph from left to right: does the graph rise up to the right (increase) or go down to the right (decrease)?



2.6 Continuous and discrete graphs

Some types of values can only be whole numbers, while others, like length measurements, can have decimal fraction values. This is important when drawing graphs, because whole numbers must be shown by points on a graph, connected by dotted lines. We call these kinds of values, and graphs, **discrete**. **Continuous** values, such as length, should be connected by solid lines, to show that the values in between the points are also included.

Continuous or discrete graphs

Look at the graphs below. The first graph shows the number of passengers on a bus for six different trips. The second graph shows the distance that a bus travels for one trip. **Explain why the first graph has dotted lines connecting the points while the second has solid lines.**

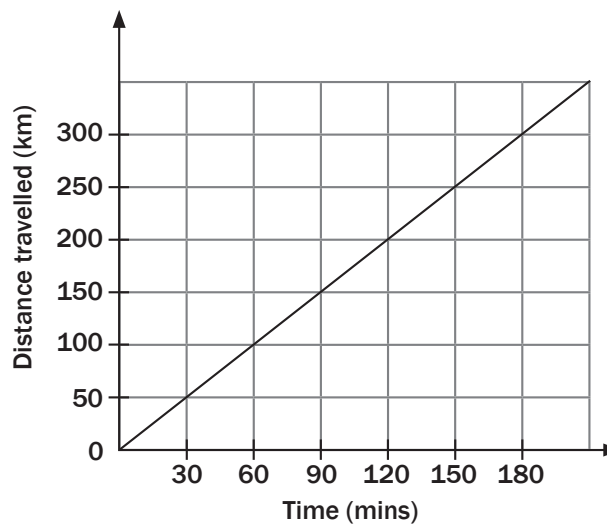
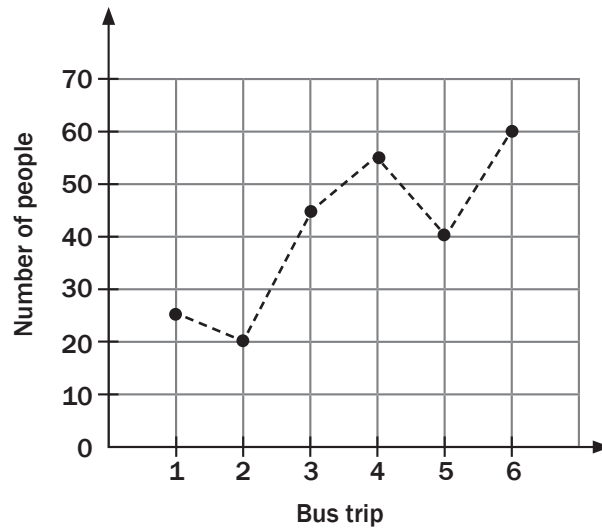

The number of people are counted in discrete (separate) units (persons), whereas time is continuous (no gaps).



Worked example 2: Interpret a graph

Naledi makes and sells beaded necklaces. Look at the graph below and answer the questions.

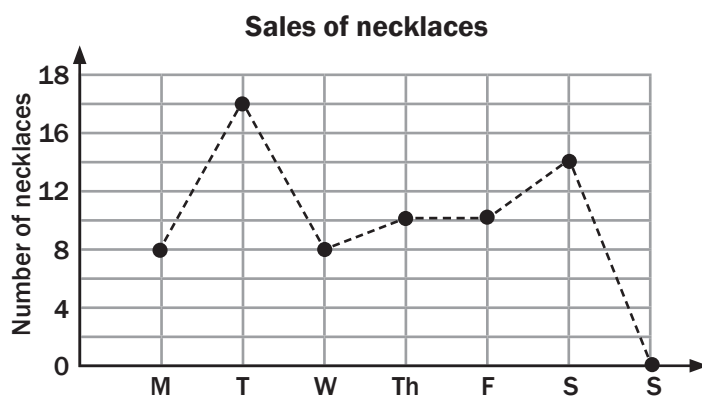

- On which day are the most necklaces sold? How many were sold on this day?
- On which day were there **no** sales? Give a possible reason for this.
- Between which two days is the biggest increase in sales? Explain.
- Between which two days do the sales stay the same?
- Describe what happens to the sales between Wednesday and Thursday.
- Why is the graph drawn with a dotted line?

Solutions

- On Tuesday, 17 necklaces.
- Sunday. People are not usually shopping on Sundays.
- Between Monday and Tuesday. Difference is $17 - 8 = 9$.
- Between Thursday and Friday.
- There is an increase in sales of 2 necklaces.
- This is a discrete graph, because necklaces are sold in whole numbers.



Activity 1: Interpret a graph

Buhle decides to graph her marks for English First Additional Language and for Mathematical Literacy on the same set of axes, for eight tests, two per school term. Look at the graph below and answer the questions that follow.

KEY: ■ Math Lit ■ EFAL

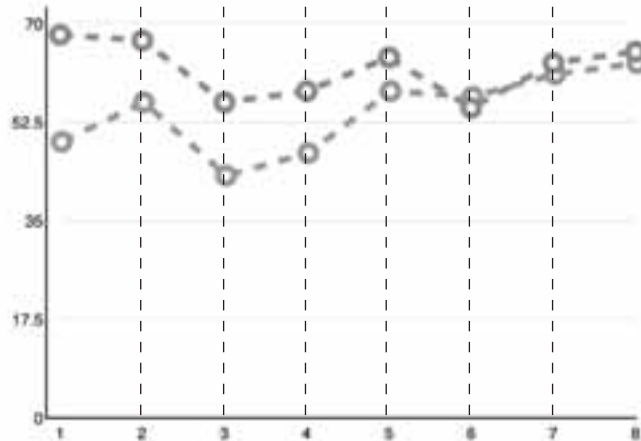

1. What is Buhle's highest mark? (1)
2. In which subject does Buhle generally score better marks? (1)
3. Does the graph show an overall improvement or an overall decline? (1)
4. What two interesting things can you tell about the marks? (2)
5. What did Buhle score for each subject in test 5? (any two) (2)
6. Is this a continuous or discrete graph, and why? (any two) (2)
7. Is this graph misleading in any way and why? (any two) (2)

[11]

Solutions

1. Approximately 68-70 for Mathematical Literacy, in Test 1. ✓ (1)
2. Mathematical Literacy. ✓ (1)
3. Overall decline (getting worse). ✓ (1)
4. The marks correlate, that is, they seem to go up and down at the same rate. ✓
They converge; that is, over time, her marks for the two subjects get more similar. ✓ (2)
5. 66% (Mathematical Literacy) ✓ and 53% (EFAL) ✓ approximately. (Note to marker: any numbers within 1-2% of these should be marked correct, i.e. 68-64 ✓ and 55-51 ✓ as long as the learner shows that they understand that one is larger than the other by a margin of about 5-6 marks (any two). (2)
6. Discrete ✓; because a learner is not constantly being tested ✓; there are only 8 tests so there cannot be items between the tests ✓; the graph is dotted ✓ (Note to marker: any two are correct) (any two). (2)
7. Yes, because the axes are not marked evenly in steps or increments of 10 ✓, and the marks are all positioned at the top, ✓ which creates the impression that Buhle is scoring well, whereas her marks are in fact just a bit better than average. ✓ (Any two). (2)

[11]

2.7 More than one line on the same graph

A graph can have more than one line. The aim is to compare two or more different situations.

You will often see this in questions about finances.

- We can put two graphs on the same set of axes, if they both compare the **same two variables**.
- The point where the two graphs meet is sometimes called the **break-even point**. (The values for the two graphs are the same at this point.)



Worked example 3

David's shop buys solar lamps for R45 each. He marks up the prices and sells them for R100 each. His monthly expenses (fixed costs) are R12 000.

- a) (i) Which expenses change? These are variable costs.
 (ii) Which expenses stay the same? These are fixed costs.
- b) Fill in both blank rows in the table below.

Number of lamps bought and sold	0	100	200	300	400	500
Total expenses						
Income						

- c) On the same grid, draw a graph of the total expenses and a graph of his income.
- d) Read from the graphs the number of lamps David needs to sell to break-even (not to make a profit or loss).
 (Assume that the amount is rounded off to the nearest R1 000 at this point).

Solutions

- a) (i) buying the lamps
 (ii) R12 000
 b) Total expenses = R12 000 + (number of lamps × R45)

Number of lamps bought and sold	0	100	200	300	400	500
Total expenses	12 000	16 500	21 000	25 500	30 000	34 500
Income	0	10 000	20 000	30 000	40 000	50 000

c) Graph:

Graph of money against number of lamps

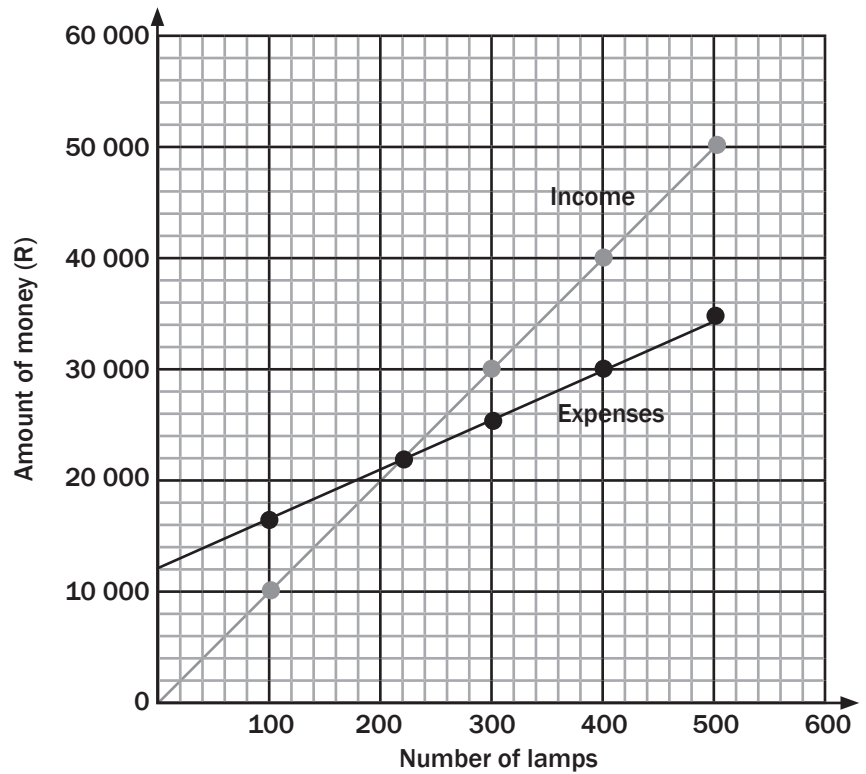

d) The break-even point is at 220 lamps.



Activity 2: More than one line on the same graph

Pieter wants to start a lift club, and he wants to know how many people he needs to give a lift to in his car in order to break even on petrol costs. People are not willing to contribute more than R 20 per day, and he gains a new passenger each week (starting with one passenger). Answer the questions that follow.

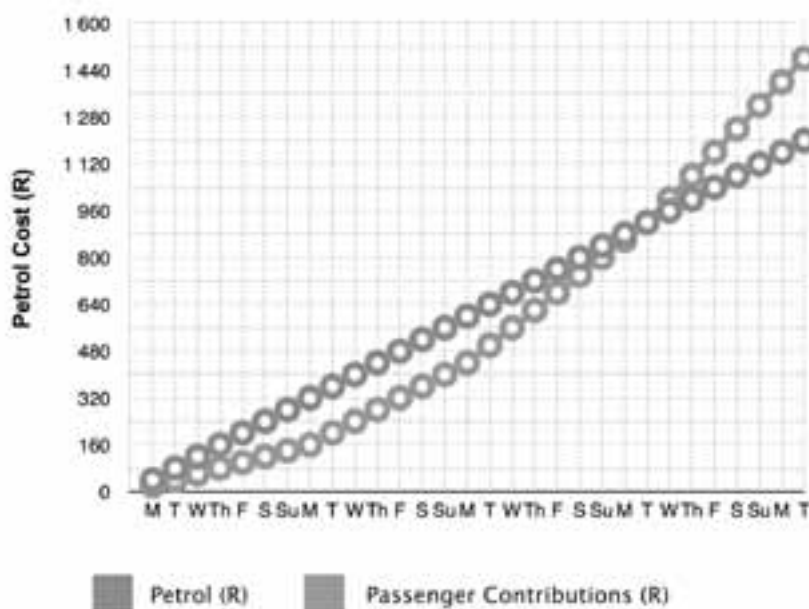

- How many people does he need to give a lift to to break even, if his petrol costs R 1200 per month? Why? (2)
- What value or quantity does the curved line show? (1)
- What day of the month does he break even? Assume that the first Monday is the 1st of the month. (1)
- Why does the curved line overtake the straight line? (1)
- What profit does he make each month? Use the income/expenditure/profit formula. (3)
- Assuming that Pieter has to service his car every six months at a cost of R 1000, is this still a viable business option for him? Why? (3)

[11]

Solutions

- Three. ✓ Because at the end of the week of having transported three people, he starts making a profit. ✓
Marker: bonus mark if they observe that two persons would never get him a profit. ✓ (2)
- Cumulative passenger contributions in Rands ✓ OR How much his passengers are paying. ✓ (any 1) (1)
- On day 23 / The 23rd. ✓ (1)
- Because he is now making a profit ✓ OR The passenger contributions or fares start to exceed his cumulative petrol cost. ✓ (any 1) (1)
- R 1480 (income) ✓ - R 1200 (expenditure) ✓ = R 280 (profit). ✓ (3)
- Since he makes R 280 profit each month, by six months, he would have made R 1680. ✓
Since the service costs R 1000, he will still make a profit of R 680 after 6 months ✓, so it is still a viable business. ✓ (3)

[11]

2.8 Direct and indirect proportion

Some relationships between quantities give patterns that form direct proportion graphs, or indirect proportion graphs.

How to recognise a direct proportion relationship

In a direct proportion, when one quantity is multiplied, the other quantity is multiplied by the same number. The resulting graph is a straight line that passes through the point (0; 0). The income graph in the worked example below shows that the income is directly proportional to the number of lamps sold.

How to recognise an indirect proportion relationship

In an indirect (or inverse) proportion, as one quantity decreases, the other increases OR as one quantity increases, the other decreases.

If we multiply the two amounts, they are always the same. Remember that when you multiply two amounts, the result that you get is called the “product”, so, product means “to multiply”.



Worked example 4

A rectangle has a fixed area of 32 square units, but the length ℓ and breadth b can both change. If the length gets smaller, the breadth gets bigger, because the area stays the same.

Area = 32 square units



- a) Complete the following table of possible values for the length and breadth of the rectangle.

length	1	2	4	8	16	32
breadth	32					

- b) Draw a graph to show all the possible values of the length and breadth.
 c) Is the graph continuous or discrete? Explain.
 d) Why does the curve not touch the axes?

Solutions

a) Table of values:

length	1	2	4	8	16	32
breadth	32	16	8	4	2	1

b) Graph of breadth and length values.

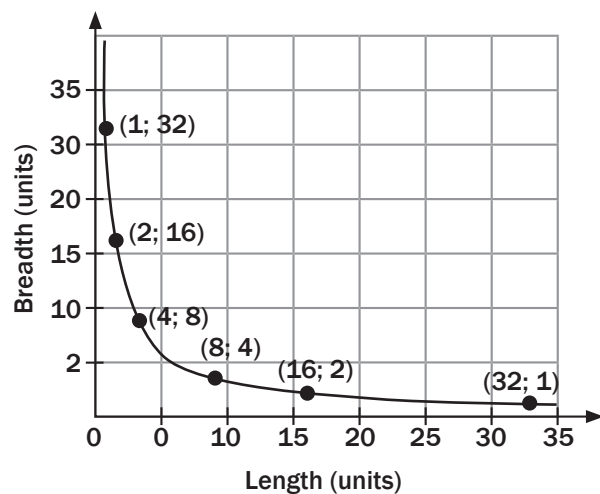

c) The measurement values are continuous values, so the graph is continuous.

d) Length and breadth cannot equal zero, so the graph does not touch either of the axes.

The important things to note about the graph of an inverse proportion are:

- it is a smooth curve with the shape shown below
- the curve never touches the **axes**
- at any point, the **product** of the two quantities is always the same.

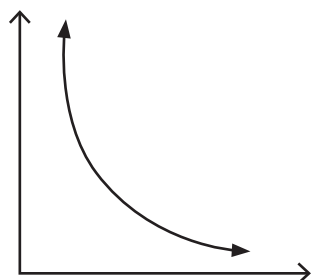

2.9 Exponential number patterns and graphs

Growth graphs

Some number patterns show exponential growth. This is a situation where the graph first increases slowly and then increases very fast.

You can recognise this in a real-life situation when an amount grows more each time.

This is different from a straight line, which shows a constant rate of growth.



Worked example 5

Increase in trees

- A farmer starts with 20 fruit trees and plants 20 more fruit trees every year. The rate of change is the same each year.
- The number of fruit trees is the dependent variable.

Number pattern

Year	0	1	2	3	4	5
Trees	20	40	60	80	100	120

This is a constant rate of growth (the rate stays the same).

The graph does show a change, but the change is the same between each point.

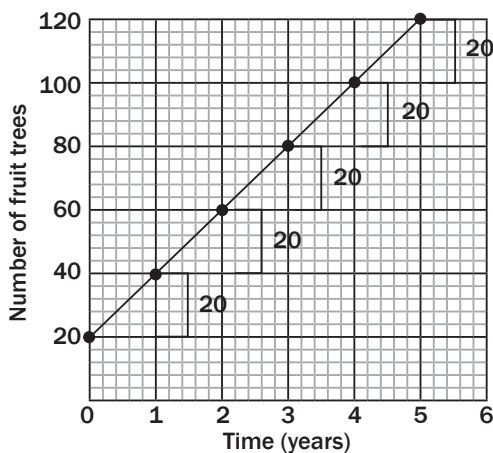

The horizontal axis shows 1 year for each space. This is the same for both graphs.

Increase in sheep

- The farmer starts with 10 sheep. Each sheep produces another lamb every year. The number of sheep doubles every year.
- The number of sheep is the dependent variable.

Number pattern

Year	0	1	2	3	4	5
Sheep	10	20	40	80	160	320

This is an increasing rate of growth.

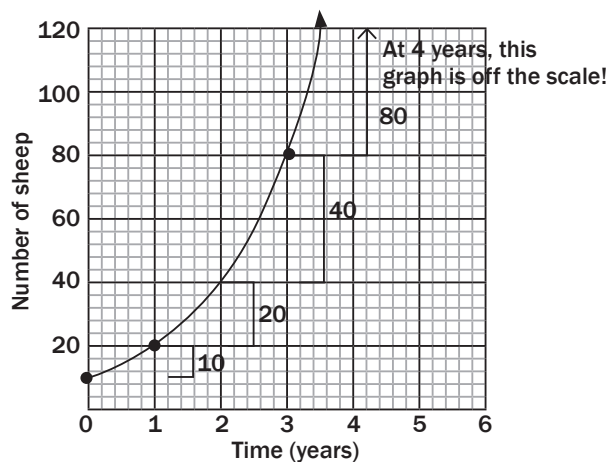

- It is a straight line graph.
- Linear number pattern.
- The constant difference is 20.
- Compound growth or exponential graph.
- Look at how the differences in the number of sheep increase each year.
- The constant ratio is 2.

Doubling is only one example of compound growth. A common example of compound growth is when someone saves an amount of money and earns compound interest on the savings.

e.g. Worked example 6

Thembi invests R1 000 at compound interest. The interest is added every year at 10% of the money she has in the account. Fill in the table to show how the money grows.

Year	0	1	2	3	4	5	6	7	8
Amount of money (R)	1 000	10% of R1 000 + 1000 = R1 100	1210	1331	1464,10	1610,51	1771,56	1948,72	2143,59



The year that she starts is called year 0, because this is when she puts in the money. No time has passed. This is where the graph starts. Plot the graph on the set of axes below.

Solution

Note: The amount will be multiplied by 110% (or 1,1) each time to get the next number in the pattern. This is a constant ratio pattern, or exponential growth.

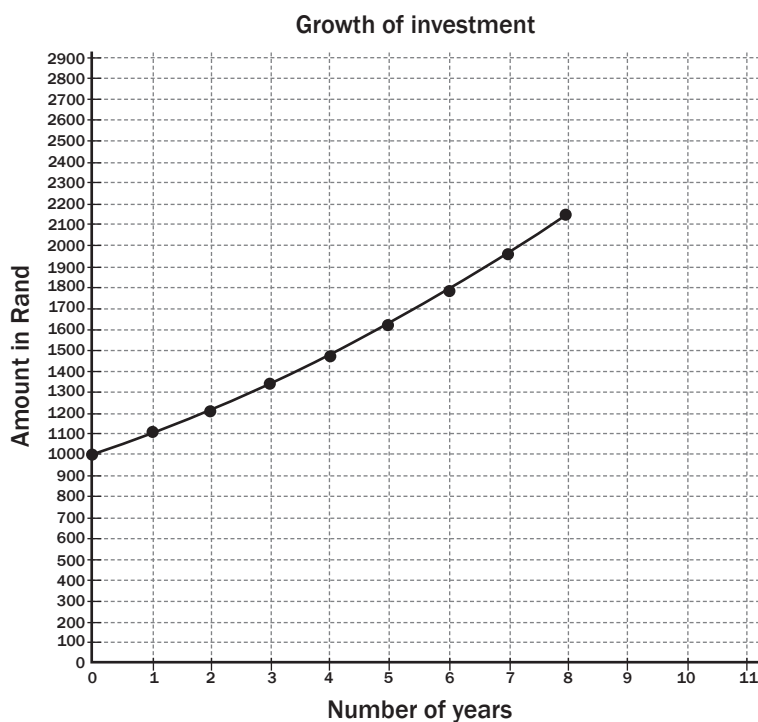

2.10 How to identify the kind of relationship in a graph

You can see what kind of graph it is by looking at the shape of the graph.
Here are some tips.

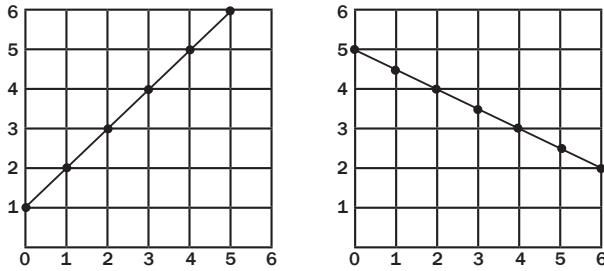
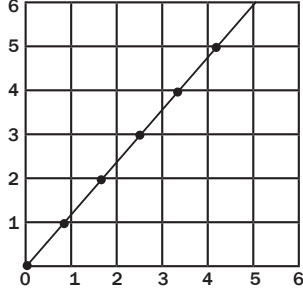
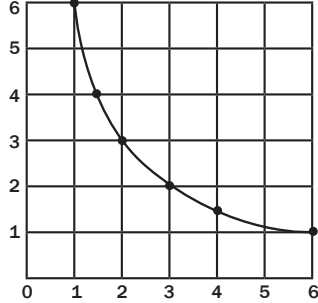
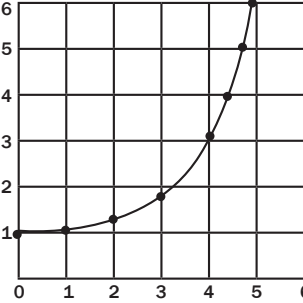
Linear graph/ straight line graph	
<p>Not in proportion</p>  <ul style="list-style-type: none"> • A straight line • Can be increasing or decreasing 	<p>If an increasing straight line graph starts at (0; 0), it shows a direct proportion</p>  <ul style="list-style-type: none"> • A straight line • Always increasing • Both quantities increase in the same proportion
<p>An inverse proportion</p>  <ul style="list-style-type: none"> • A curve • Does not touch either of the axes • As one quantity increases, the other one decreases 	<p>An exponential graph of growth</p>  <ul style="list-style-type: none"> • A curve • An increasing graph • Touches the vertical axis • The vertical quantity increases more and more quickly.

2.11 Reading the scale of a graph

When you are analysing a graph, check the scale on the axes. The scale means the number of things that each space on the graph represents.



Activity 3: Reading a graph scale

Answer the questions below about this graph.

Spend a few minutes looking at the graph before you start. Write the scale on the graph and some other quick notes, to help you understand the graph.



Use a ruler and pencil to help you read off the graph grid correctly.

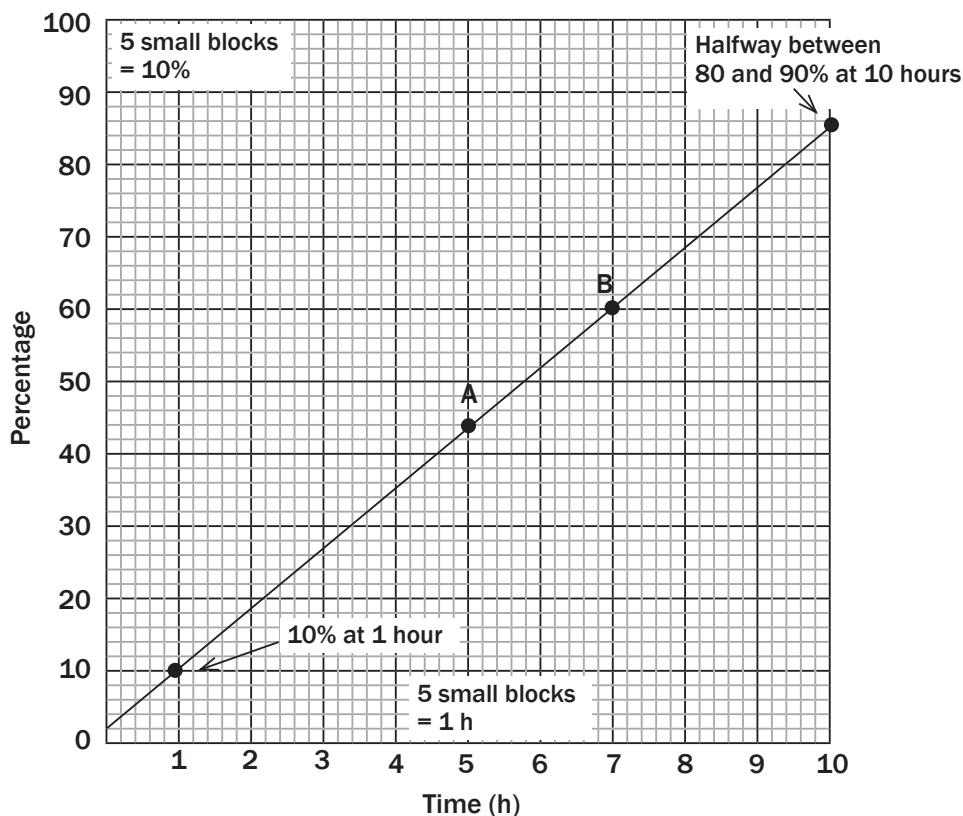

- How many blocks represent 10% on the vertical axis? (2)
 - How many blocks represent 1% on the vertical axis? Why? (3)
- Describe the scale on the horizontal axis. (2)
- What percentage is reached at 10 hours? (2)
- Where does the line begin? (1)
- Give the values at A and B in percentages and hours. Give your answer in two ordered pairs. (7)

[17]

Solutions

1. a) 1 large block, which has 5 small blocks, represents 10%. (2)
- b) One half of a small block represents 1%. This is because one small block represents $10\% \div 5 = 2\%$. (3)
2. 1 large block represents 1 hour. This means that one small block represents 0,2 h or one fifth of an hour. (2)
3. The percentage at 10 hours is halfway between 80% and 90%, so it is 85%. (2)
4. The line begins at 0 h and 2%. (1)
5. A is at exactly 5 hours. A is between 40% and 50%. It is 2 small squares up from 40. Each small square represents 2%, so the 2 squares show 4%. A is (5; 44) and B is (7; 60). (7)

[17]

Finance

3.1 Financial documents

You need to be able to find information from a variety of documents (till slips, account statements and bills). You also need to understand and check the calculations.

3.1.1 Till Slips

Every time you buy an item from a shop, you should receive a till slip. By law, South African till slips must include:

- the name of the shop
- the address of the shop
- the VAT number of the shop
- the words “Tax Invoice”
- the shop’s invoice number
- the date and time of the sale
- a description of the items or services bought
- the amount of VAT charged (14%)
- the total amount payable.

VAT is not charged on some essential groceries in South Africa. These include : paraffin; brown bread; maize meal; samp; mealie rice; dried mealies; dried beans; lentils; tinned sardines; milk powder; milk; rice; vegetables; fruit; vegetable oil and eggs.



Worked example 1

SUNSHINE SUPERETTE	
Welcome to our Store 7th Street Melville Tel No: 011 482 1992 VAT NO 1340763486 ---TAX INVOICE---	
Retain as proof of purchase	
LAST DAY FOR A FULL REFUND IS 27/07/2013	
VEGETABLE SOUP INST	R6,95
MINI TENNIS BISCUIT	R3,95
50G BILTONG	R19,99
24 LITRE VFC (FOODS)	R0,44
500ML VEG OIL	R16,99 *
YOGHURT 175G	R5,49
BREAD/BROWN	R6,99 *
1L MILK/LOW FAT	R11,95 *
COFF/CHEESE 250G	R15,99
SHAMPOO	R15,99
MUFFINS/CHOC	R13,95
11 BALANCE DUE	R130,27 A
CASH PAYMENT	R150,00
CHANGE	R19,75
Rate	
14,00%	Vat 11,59 B
+ 0,00%	0,00
TOTAL	R94,34 C
	R35,93 D
28/05/2013 18:15 CASHIER - Babalwa Noza	
Visit Our Website www.sunshinesuper.co.za Customer helpline 086 1456 345	

Boiketlo goes to buy groceries at the Sunshine Superette. Study the till slip alongside and answer the questions that follow.

- How did Boiketlo pay for her shopping?
- How much does 1 litre of vegetable oil cost at the Sunshine Superette?
- If there are 6 muffins in the pack of chocolate muffins that Boiketlo bought, how much does each muffin cost?
- What is the last date for a refund and why might Boiketlo need a refund?
- Boiketlo gave the cashier R150,00 and received R19,75 change.
 - Calculate what she paid for her shopping.
 - Why do you think the amount is slightly different to the balance due?
- Why do three items (vegetable oil, brown bread and milk) have stars next to them?
- Add up the total of the items which are subject to VAT.
 - Calculate the VAT (14%) of the total value of these items. Which letter (A, B, C or D) on the till slip does this correspond to?
 - Add the 14% VAT to the total value of the items which are subject to VAT. Which letter (A, B, C, or D) on the till slip does this correspond to?
 - Add up the total of the three items that are exempt from VAT. Which letter (A, B, C or D) on the till slip does this correspond to?
 - Add together the total (including VAT) of the items that include VAT and the total of the VAT exempt items. Which letter on the till slip does this correspond to?

Solutions

- She paid with cash.
- 500 ml of vegetable oil costs R16,99, so 1 litre costs $R16,99 \times 2 = R33,98$.
- 6 muffins cost R13,95, so one muffin costs $R13,95 \div 6 = R2,33$.
- 27/07/2013. She may need a refund if the food she bought is stale.
- $R150,00 - R19,75 = R130,25$.
 - The amount she paid is 2c less than the balance due. The total has been rounded to the nearest multiple of 5c because we no longer use 2c and 1c coins in South Africa.
- The three starred items are exempt from VAT, because they are basic foodstuffs.
- $R6,95 + R3,95 + R19,99 + R0,44 + R5,49 + R15,99 + R15,99 + R13,95 = R82,75$.
 - 14% of $R82,75 = 82,75 \times 0,14 = R11,59$: Letter B.
 - $R82,75 + 11,59 = R94,34$: Letter C.
 - $R16,99 + R6,99 + R11,95 = R35,93$: Letter D.
 - $R94,34 + R35,93 = R130,27$: Letter A.



Activity 1: Till slip

Sakhile goes to his local store and buys some clothes and groceries. He receives the following till slip. Study the slip and answer the questions that follow.

1. What item did Sakhile buy on sale, and how much was the discount? (2)
2. Can Sakhile return the sale item for refund? Explain your answer. (2)
3. How many eggs did Sakhile buy? (1)
4. Calculate the total value of the VAT exempt items Sakhile bought. (2)
5. Demonstrate how the amount indicated by Letter A was calculated. Show all your calculations. (3)
6. Demonstrate how the amount indicated by Letter B was calculated. Show all your calculations. (5)

[15]

GREEN MARKET STORE	
Welcome to our Store 21 Brickfields Rd Tel No: 031 645 1228 VAT NO 156892340075 Retain as proof of purchase	
LAST DAY FOR A FULL REFUND IS: 18/04/2013 Except for SALE items purchased	
T-SHIRT/RED	23.99
R47.98 less sale 50% R23.99	
TRACK PANTS/GREY	89.99
SARDINES/200G TIN	20 5.99 *
BISCUIT/GINGER 500G	14.49
0.5L MILK	6.95 *
TOMATOES 1KG	11.95 *
EGGS 6 JUMBO	20 7.99 *
SUNDAY TIMES NEWS	15.99
CRISPS/CHEESE	6.69
*** TOTAL	219.17 — B
CARD FNB	219.17
ACCOUNT NR *****47054	
CHANGE	0.00
Total Promotion Disc	23.99
-----TAX INVOICE-----	
14% VAT	21.16 — A
VAT TOTAL	21.16
-----VALID VAT INVOICE-----	
18/03/2013 13:10 CASHIER - James Hatfield	

Solutions

1. A red T-shirt, ✓ 50% discount. ✓ (2)
2. No, ✓ full refunds are only available for non-sale items. ✓ (2)
3. 2 packs of 6, so 12 eggs. ✓ (1)
4. $2(R5,99) + R6,95 + R11,95 + 2(R7,99) ✓ = R46,86. ✓$ (2)
5. VAT incl. items total R151,15. ✓ 14% VAT ✓ of this = R21,16. ✓ (3)
6. Non-VAT items total R46,86. ✓ VAT incl. ✓ + VAT excl. ✓ + R21,16. ✓
VAT = R219,17. ✓ (5)

[15]

3.1.2 Account statements

At some clothing and food stores, it is possible to open an account, buy goods on credit and pay off what you owe the store on a monthly basis.



MISS BN DUBE
25 HARRINGTON HOUSE
BEACH RD
PORT ELIZABETH

7450

CREDIT AVAILABLE
3307.00

Date: **07/05/12**
 Account Number: **4056747070001001001**

STATEMENT

Edgars, Boardmans, Prato, Temptations and GHA trading as divisions of Edcon (Pty) Limited
 1 First Avenue, Cross Street, 2092 Registration No. 2007/003425/07 NCR Reg. No. NCRCP62 EMAIL: ACCOUNTS@EDCON.CO.ZA

DATE	REF NO:	DETAILS	AMOUNT	BALANCE
25/04/12		OPENING STATEMENT BALANCE		692.42
		ATM PAYMENT	240.00	452.42
24/04/12		6 MONTHS PLAN		
25/04/12		PURCHASE EDG WALMER PARK	99.95	552.37
		PURCHASE EDG WALMER PARK	190.00	742.37
CLOSING STATEMENT BALANCE				742.37

Use the Account Number above as your Reference Number if you are paying electronically, and please ensure your bank links your payment to the following bank account:

FNB BRANCH CODE 251105
ACCOUNT NUMBER 50451141440

PLEASE NOTE: Even if you don't receive a statement every month, you must pay Total Due to avoid late payment charges

CREDIT LIMIT
 You now have: **4049**
 You qualify for:
 For credit limit increases, account enquires and address or telephone number changes call:

0860 112 442 (South Africa, Lesotho and Swaziland)
061 225 432 (Namibia)
0800 133 268 (Botswana)

Office Hours:
 Mon-Wed 09:00 - 18:00
 Thu 09:00 - 19:00
 Fri 09:00 - 21:00
 Sat 09:00 - 18:00
 Sun & Public Hol 09:00 - 17:00

Late charges at 22.18%PA will be added to your account.
 A 50.00 admin charge will be added to all processing statements that have been outstanding.

FROM 6 MAY 2012, THE PREMIUM ON YOUR EDGARS ACCOUNT PROTECTION PLAN AND/OR ACCOUNT PARTNER PROTECTION PLAN WILL INCREASE FROM 33 CENTS PER 100.00 TO 35 CENTS PER 100.00. FOR FURTHER INFORMATION CALL 0860 112 442.



Worked example 2

Bulelwa has an Edgars store account. She receives the account statement shown above.

- a) At which six stores can Bulelwa use her store card?
- b) (i) How much must she pay on her account?
(ii) When is this amount due?
(iii) Will she be charged extra if she pays the due amount late? If so, how much?
- c) How much did Bulelwa pay into her account on 25/04/2012?
- d) (i) How much credit does she still have available?
(ii) What is the difference between “credit available” and “credit limit”?
- e) How much is the balance brought forward from the previous statement?
- f) How much did Bulelwa spend at Edgars in the month of April 2012?
- g) The closing balance on this statement includes 14% VAT. Calculate the VAT included in the closing balance of R742,37.

Solutions

- a) Edgars, Boardmans, Prato, Temptations, CNA and Red Square.
- b) (i) R240,00.
(ii) 01/06/2012.
(iii) Yes. A charge of 22,10% per annum is added to late payments.
- c) She paid R240,00 into her account.
- d) (i) Bulelwa has R3 307,00 credit on her account.
(ii) Credit available is how much credit Bulelwa has left. Credit limit is how much credit is allowed in total, at any one time (i.e. she can buy items totaling R4 049 on credit).
- e) R692,42.
- f) $R99,95 + R190,00 = R289,95$.
- g) The closing balance is 114% of the balance before VAT was added.
The VAT is 14% of this final amount.
So, $VAT = R742,37 \div 114\% \times 14\%$
 $= R742,37 \times 14 / 114$
 $= R91,17$.



Activity 2: Reading an account statement

Jet Stores		★	Edgars Stores	▲	CBS stores
Ms D T Bears 222 Straight Str Hababa City 1313			Credit available: R1 550,35		
			Date: 02/06/2011		
			Account number: 3472411756		
			Statement e-mail address debt@jetstores		Instalment R280.00
Date	Ref. no.	Details	Amount	Balance	Total Due R280.00
22/05/11		Opening balance		3 450.15	Due Date 07/06/2011
22/05/11		Cash payment Thank you!	280.00	3 170.15	Credit limit R5 600.50
23/05/11		12 months plan Purchase Jet Menlyn	55.50	3 225.65	Enquiries 0860231453
		Purchase Jet Menlyn	120.15	3 345.80	Office Hours 8:00 -18:00
		Purchase Jet Menlyn	500.00	(a)	
Closing balance				(b)	

Study the account statement above and answer the following questions.

1. What is Daisy's opening balance? (1)
2. How much is her credit limit? (1)
3. Why is there a due date on the statement? (2)
4. Calculate the value of the goods she purchased this month. (2)
5. Calculate the values (a) and (b). (2)
6. The company charges 33% per annum on late payments. How much will Daisy owe if she does not pay the R280,00 installment until 07/07/2011? (6)
7. The closing balance includes VAT. Calculate the original total, excluding VAT. (2)
8. Why is the "Credit Available" amount not the same as the "Credit Limit"? (2)

[18]

Solutions

1. R3 450,15. ✓ (1)
2. R5 600,50. ✓ (1)
3. To regulate payment ✓ and also add charges ✓ if the account is not paid by that date. (2)
4. Purchases = R55,50 + R120,15 + R500,00 ✓
= R675,65. ✓ (2)
5. (a) R3 845,80. ✓ (b) R3 845,80. ✓ (2)
6. $(33/100 \times R280,00) \div 12 = R7,70$. ✓✓ (6)
She will owe R3 845,80 ✓ - R280 ✓ + R7,70 ✓
= R3 573,50. ✓
7. VAT (excl.) Price = R3 845,80 ✓ $\div 1,14 = R3 373,51$. ✓ (2)
8. It shows that she still owes the company ✓, although they gave her buying power of R5 600,50. ✓ (2)

[18]

3.1.3 Bills

Municipal bills

A household must pay municipal charges for rates, water and electricity.

Page 1 of 2



THIS CITY WORKS FOR YOU

MRS J. GWAYI
145 GORDON AVE
MOWBRAY
7853

Civic Centre
12 Hertzog Boulevard 8001
PO Box 655 Cape Town 8000
VAT Registration number
4500192497

Tax invoice number **160003571479**

Customer VAT registration number

Account number **634812459**

Distribution code

Business partner number **1001923733**

Tel: 086 010 3089 • Fax: 086 010 3090
Tel: overseas clients +27 21 401 4701
E-mail: accounts@capetown.gov.za
Correspondence: Director: Revenue, P O Box 655,
Cape Town 8000
Web address: www.capetown.gov.za

Account summary as at 23/08/2013		Due date 19/09/2013
At 145 GORDON AVE / MOWBRAY / Erf 26146		
Previous account balance		2032.67
Less payments (29/07/2013) Thank you		349.67-
Arrears (a)	Payable immediately	1683.00
Latest account - see overleaf		393.72
Current amount due (b)	Payable by 19/09/2013	393.72
	Total (a) + (b)	2076.72
Total (a) + (b) above	2076.72	
Total liability	2076.72	



Electricity is expensive. Saving is simple.
For top electricity saving tips, visit www.loadingelectricity.org.za

Our dam levels are below average - save water and repair leaks.

Please note:

- Cheques must be made payable to the City of Cape Town. Post-dated cheques will not be accepted.
- Interest will be charged on all amounts still outstanding after the due date.
- Failure to pay, could result in your water and/or electricity supply being disconnected/restricted. Immediate reconnection of the supply after payment cannot be guaranteed. A disconnection fee will be charged and the amount of your deposit may be increased.
- You may not withhold payment, even if you are engaged in a dispute with the City concerning this account.
- A convenient debit order facility is available. For further details please phone 086 010 3089.
- Bank charges on payment amounts in excess of R4 000,00 made by credit/debit card will be debited to your account.
- When making a direct deposit at ABSA Bank, please state your account no. 209671750.
- Register at your bank for internet payments. Log onto your bank's website and select 'City of Cape Town Municipality' and insert your nine-digit municipal account number in the beneficiary reference field. Please ensure that there are no spaces between the numbers.

Payment: At any City of Cape Town cash office or the following:

ABSA Checkers SHOPRITE Post Office

MRS J. GWAYI



>>>> 915552096717502

Account number **634812459**

Amount due if not paid in cash **2076.72**

Amount due if paid in cash **2076.70**

Rounded down amount carried forward to next invoice **0.02**



Worked example 3

Look at the municipal bill given on the previous page.

- a) Mrs Gwayi received the above municipal invoice for electricity and refuse.
 - (i) At which four stores or outlets can she pay for electricity and refuse?
 - (ii) If Mrs Gwayi wants to query this bill, what number should she phone?
- b) (i) According to the bill, when did Mrs Gwayi last make a payment to the municipality?
 (ii) How much was her last payment?
- c) If Mrs Gwayi receives the invoice on 10 September 2013:
 - (i) What is the minimum amount that she needs to pay immediately?
 - (ii) What additional amount must she pay before 19 September?
- d) If Mrs Gwayi wants to pay her invoice in full, what is the total amount she owes?
- e) The total amount due ('total liability') includes 14% VAT but that percentage is not listed separately on this invoice. Calculate the VAT included in the total amount. Round off your answer to 2 decimal places.

Solutions

- a) (i) She can pay at Absa, Checkers, Shoprite and the Post Office.
 (ii) 086 010 3089
- b) (i) 29/07/2013
 (ii) R349,63
- c) (i) R1 683,00
 (ii) R393,72
- d) R2 076,72
- e) Total amount = R2 076,72

$$\text{VAT} = 2\,076,72 \times 14 \div 114$$

$$= \text{R}255,04$$



Activity 3: Municipal bills

Study the Eskom bill below and answer the questions that follow.



ESKOM HOLDINGS SOC LIMITED REG NO 2002/015527/06
VAT REG NO 4740101508

DU PLESSIS, ROBERT
PO BOX 8453
PORTERVILLE
7925

CENTRAL REGION
PO BOX 8610 JHB 2000

CONTACT CENTRE: (0860) 037566
FAX NO: (0866) 979065
E-MAIL: CENTRAL@ESKOM.CO.ZA
WEB: WWW.ESKOM.CO.ZA

YOUR ACCOUNT NO	6392794507
SECURITY HELD	3097.96
BILLING DATE	2012-07-12
TAX INVOICE NO	639279492961
ACCOUNT MONTH	JULY 2012
CURRENT DUE DATE	2012-08-06
VAT REG NO	NOT SUPPLIED
NOTIFIED MAX DEMAND	25.00



TEL: 08600 37556
SMS: 082 941 3707
083 647 1951
084 655 5778

CUSTOMER SELF SERVICE WEBSITE:
<https://csonline.eskom.co.za/>

CENTRAL REGION
PO BOX 8610 JHB 2000

DIRECT DEPOSIT DETAIL	
BANK:	First National
BRANCH CODE:	255405
BANK ACC NO:	62005191077

TAX INVOICE

E-MAIL: No email address supplied

READING TYPE: ACTUAL	READING DATES: 2012/05/10 - 2012/07/10	NO OF DAYS: 61	SEASON		
Your next actual reading will be on 10/08/2012					
CONSUMPTION SUMMARY FOR BILLING PERIOD					
METER NUMBER	PREV. READING	CURR. READING	DIFFERENCE	CONSTANT	CONSUMPTION
356413	36067.0000	39034.0000	3,019.0000	1,0000	3,019.0000
382471	60664.0000	63437.0000	2,773.0000	1,0000	2,773.0000
382709	50248.0000	50556.0000	608.0000	1,0000	608.0000
TOTAL ENERGY CONSUMED FOR BILLING PERIOD (kWh)					6,400.00

PREMISE ID NUMBER 9161190613 **TARIFF NAME:** Homepower Standard

STAND 00145 128 OAK STREET

Energy Charge (<= 50 kWh) 85 kWh @ R0.5883 /kWh : (for 51 of 30 days) R 50.01
 Energy Charge (<= 50 kWh) 17 kWh @ R0.5733 /kWh : (for 10 of 30 days) R 9.75
 Energy Charge (> 50 kWh <= 350 kWh) 510 kWh @ R0.7309 /kWh : (for 51 of 30 days) R 372.76
 Energy Charge (> 50 kWh <= 350 kWh) 100 kWh @ R0.7159 /kWh : (for 10 of 30 days) R 71.59
 Energy Charge (> 350 kWh <= 600 kWh) 524 kWh @ R1.0942 /kWh : (for 51 of 30 days) R 465.04
 Energy Charge (> 350 kWh <= 600 kWh) 83 kWh @ R1.0792 /kWh : (for 10 of 30 days) R 89.57
 Energy Charge (> 600kWh) 4,331 kWh @ R1.2021 /kWh : (for 51 of 39 day) R 5,206.30
 Energy Charge (> 600kWh) 849 kWh @ R1.1871 /kWh : (for 10 of 33 days) R 1,007.85
 Retail Environmental levy charge 5,351 kWh @ R0.02 /kWh R 107.02
 Retail Environmental levy charge 1,049 kWh @ R0.035 /kWh R 36.72

REBILLED ADJUSTMENTS (Summary - See attachment for details) R -3,062.76

TOTAL CHARGES FOR BILLING PERIOD R 4,353.85

ACCOUNT NO / REFERENCE NO
6392794507

NAME
DU PLESSIS, ROBERT

FAX NUMBER

TOTAL AMOUNT DUE

4,963.40

ARREARS				CURRENT	TOTAL AMOUNT DUE	R	4,963.42
>90 DAYS	61-90 DAYS	31-60 DAYS	0.00				
0.00	0.00	0.00	4,963.42	TOTAL AMOUNT DUE			R 4,963.42

Balance brought forward is reflected in the current amount and must be paid by 2012-17-14 to avoid disconnection. Please ignore if already paid.

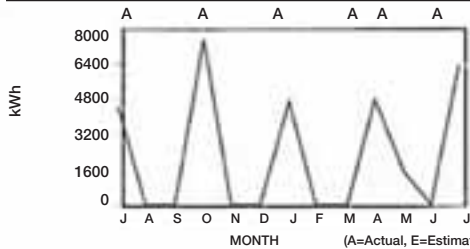

kWh

MONTH (A=Actual, E=Estimate)

Message

Save electricity if you are not using an appliance, please switch it off

PAGE RUN NO	PP1624
BILL GROUP	
BILL PAGE	1 OF 2

PAYMENT ARRANGEMENT

INSTALMENT 0.00

ARREARS 0.00

DUE DATE 2012-08-06

AMOUNT PAID

LATE PAYMENT CHARGES WILL BE ADDED TO OVERDUE ACCOUNTS



Mr du Plessis gets the account for his electricity consumption over 2 months (see above bill). He has three electricity meters on his property for two small houses and a flat on the premises and they are billed together.

1.
 - a) What is the total amount due? (1)
 - b) What does “billing period” mean and how long is it in this case? (4)
 - c) When did Mr du Plessis last pay his electricity account and how much did he pay? (2)
 - d) Why is the amount for “Payment(s) Received” negative (-R2 520,25)? (3)
 - e) What do you think “Balance brought forward” means? (3)

2. The consumption levels for the first two meters listed (meter numbers 356413 and 382471) are fairly similar, both close to 3 000 kWh. The consumption level for the third meter (number 382709) is much lower.
 - a) Why do you think this might be so? (2)
 - b) Give examples of factors that might increase a household’s electricity consumption. (2)

3. The graph in the bottom left corner of the invoice shows the meter readings for Mr du Plessis’ electricity consumption over the previous 12 months.
 - a) What do you think the letters under the horizontal axis mean? Is there anything unusual about their order? (2)
 - b) What does the spiky shape of the graph indicate? Give a possible reason for why the consumption (in kWh) is high for some months and at zero for others. (3)
 - c) Can you see a pattern between the high points (spikes) on the graph and the number of months that has passed? What does this pattern suggest about how often Mr du Plessis’ metre is read? (3)

[25]

Solutions

1.
 - a) R4 963,42 ✓ (1)
 - b) The billing period is a specific number of days ✓ covered by the invoice. The standard billing period is one month. ✓ In this case it is 61 days ✓, so this invoice includes electricity consumption for the 61 days before the billing date. ✓ (4)
 - c) His last payment was on 2012-06-27, for R2 520,25. ✓✓ (2)
 - d) The amount is negative to indicate that R2 520,25 ✓ was subtracted from what Mr du Plessis owed. (This payment is called a credit ✓ – it is money being paid into the account). ✓ (3)
 - e) “Balance brought forward” is the amount of money from the previous ✓ invoice that must be paid, or is still outstanding. In this invoice, the amount still outstanding was due to be paid by 2012-07-14 ✓, and Mr du Plessis paid it in full on 2012-06-27. ✓ (3)

- 2. a)** If the third meter is for the small flat on the property, for example, then the consumption will be lower ✓ because there will be fewer ✓ lights and plugs. (2)
- b)** One major factor that affects how much electricity people use is the weather. In winter, ✓ for example, people use more ✓ lighting (because it gets dark ✓ earlier), heaters, electrical blankets, and appliances like tumble driers. (any 2) (2)
- 3. a)** The letters under the graph stand for the months of the year. They are not in the usual order (J (January), F (February), M, A, etc.) ✓ but are arranged in the order of the last months starting 12 months ago and ending with the most recent month (J (July), A (August) ✓, S (September) to J (June)). (2)
- b)** The large spikes indicate when the meter reading for consumption was high ✓, and the flat segments of the graph indicate that it was at 0kWh ✓. It is unlikely that Mr du Plessis used no electricity in the months when the meter reading was zero – it is more likely that the meter was not read at all (for example, if no one was home when the meter reader arrived) in those ✓ months, and so consumption was entered into the system as being 0kWh. (3)
- c)** Initially, the peaks in the graph occur once every three months ✓ (July, October, January, April). Then the graph changes and there are non-zero readings for April and May ✓, no reading for June and again a reading for July ✓. So, from July 2011 to April 2012, the meter was read once every 3 months. Then it was read for 2 consecutive months (April and May), and then again two months later. (3)

[25]

Cell phone bills

Many different cell phone packages are available for pre-paid or contract accounts. You need to decide on your own needs, and then work out which account would be best for you.



Worked example 4

TAX INVOICE



MTN Service Provider (Pty) Limited
 215 14th Avenue, Fairland, Roodepoort, 2195
 Private Bag 9955, Cresta, 2118
 MTN SP Reg. No.: 1993/002648/07
 VAT Registration No.: 4130141247

CUSTOMER CARE ENQUIRIES
 Tel.: +28(0)83-1-808
 Tel.: 808 (free from MTNSP cellphone)
 E-mail: mtmsp@mtn.co.za
 Website: www.mtmsp.co.za



Mr Rael Finlay
 Mr Rael Finlay
 103 The Vines
 Alphen Mill Road
 MAYNARDVILLE
 -
 7834

VAT REG. NO.:		INVOICE NO.:	
ACCOUNT NO.:		INVOICE DATE:	
CELLPHONE NO.:		NAME:	

Standard Services currently available on your package

BASIC DATA AND FAX

BIS

BASIC TELEPHONY

CALLING LINE IDENTITY

MOBILE ORIGINATING SMS

CONFERENCE CALLING

PACKET SWITCHED DATA

ALLOW INTERNATIONAL DIALLING

Unless a query is raised in respect of the contents of this bill within 30 days from the date thereof, the contents shall be deemed to be correct.

Please note: all disputes which have not been resolved by MTNSP may be referred to the Ombudsman at oia@emas.co.za and/or 083 209 2677 / 083 209 2678

DATE	TRANSACTION	AMOUNT
20/05/2012	BLACKBERRY INTERNET SERVICE HIGH	51.75
20/05/2012	BLACKBERRY SERVICE FEE DISCOUNT	-51.75
20/05/2012	CALL LINE IDENTITY MONTHLY FEE	7.02
20/05/2012	PROMO SERVICE FEE	86.84
20/05/2012	MTN 200 TopUp SUBSCRIPTION	175.44
20/05/2012	CLI MONTHLY DISCOUNT	-7.02

TOTAL EXCLUDING VAT	262.28
VAT AT 14.00 %	36.72
TOTAL	R 299.00

Dial *141*9# and this could be less
 Join the MTN 1-4-1 Loyalty programme and you save on your monthly bill
 Dial *141*9#Your ID Number# from your phone or visit www.mtn.co.za/loyalty to join for free.

LAST SIX BILLING PERIODS

11-2011	12-2011	01-2012	02-2012	03-2012	04-2012
R 398.00	R 299.00	R 299.00	R 299.00	R 299.00	R 299.00

AVERAGE SPENT	R 315.50
----------------------	-----------------

Study the mobile phone invoice on the previous page.

- a) What is Mr. Finlay's cell phone number?
- b) What kind of cell phone do you think Mr. Finlay owns? Explain your answer.
- c) For which service did he receive a 100% refund? Explain your answer.
- d) Does Mr. Finlay receive any other discounts? If so, what were they?
- e) What is the most expensive item in the list of transactions? What do you think this amount is for?
- f) How do we know that Mr. Finlay has been an MTN client since at least November 2011?
- g) Can Mr. Finlay make calls to international numbers on his phone? Explain your answer.
- h) How many days does he have to query this invoice?
- i) MTN includes the average spent per month, over the last 6 months. Show how they calculate this average.
- j) Show how MTN calculated the 14% VAT that is added to the total excluding VAT.

Solutions

- a) 081 423 7012
- b) The transaction column lists his phone as a Blackberry.
- c) The Blackberry Internet service (added and then subtracted)
- d) Mr. Finlay received a R7,02 discount for "CLI Monthly Discount".
- e) The most expensive item is "MTN 200 TopUp Subscription". This is the fixed amount that Mr. Finlay pays for his cell phone contract (an MTN TopUp 200 type contract) each month.
- f) The invoice includes Mr. Finlay's last 6 billing periods, the first of which is dated 11-2011.
- g) Yes. One of the "Additional Services" listed in the grey column on the left hand side of the page is "Allow International Dialling".
- h) Mr. Finlay has 30 days to query the invoice.
- i) Average = Total amount over 6 months \div number of amounts

$$= (398 + 299 + 299 + 299 + 299 + 299) \div 6$$

$$= 1\,893 \div 6 = R315,50$$
- j) Total excluding VAT = R262,28

$$14\% \text{ of } R262,28 = R262,28 \times 14 \div 100 = R36,72$$



Activity 4: Cell phone bill



STROOM / 204 / 01 / 000000 / 241004 / *



L9243867-2
OLIVER MICHAELS
407 MONTFRERE
1 CLAIR STREET
WESTDENE
BLOEMFONTEIN
6523

Tax invoice

Account number: **L9243867-2**
Date: **03/07/2012**
Your VAT registration number:

All data Contract customers on any data bundle will qualify for additional data to be used between midnight and 5am, e.g. if you have a MyMeg 250, you will get another 250MB of Night Owl. This offer excludes Top Up and Prepaid customers. T&Cs apply.

Account summary:

Date	Description	Item number	Reference	Amount	Total
04/06/2012	Balance Brought Forward			99.00	99.00
03/07/2012	Payment	8C21369863	159019863	-99.00	0.00
03/07/2012	Invoice	B227108838	726371238	99.00	99.00

Invoice summary:

Cellular number: **0731455720**
Invoice number: **B227108838**
Due date: **31/07/2012**

Description	Amount	VAT	Total
Subscription Services			
Data Promoton - Top Up MyGig1	July 86.84	12.16	99.00
HSDPA Voice Tariff	July 0.00	0.00	0.00
VAS - Balance Notification	July 5.70	0.80	6.50
VAS- Free Balance Notification	July -5.70	-0.80	-6.50
Total Subscription Services	86.84	12.16	99.00
Subtotal	86.84	12.16	99.00
This invoice amount	86.84	12.16	99.00

>>> 9 2060 1903 149 721 9

Invoice Total

99.00

Page 1 of 1

Your bank account will be debited with the full outstanding balance as reflected on this statement on the 1 August 2012.
Vodacom (Pty) Ltd. Registered office: P O Box 3306 Claremont 2000. Company Registration No. 1993/003367/07. V A T Registration No. 401013921

Oliver receives the cell phone bill on the previous page.

1. What is the balance brought forward from the previous invoice? (1)
2. On what date was the payment of this balance made? (1)
3. When is the payment for the current outstanding amount due? (1)
4. What subscription service does Oliver get for free? (1)
5. What subscription does Oliver get a full refund for? (1)
6. What is the billing period for this invoice? (1)
7. Oliver wants to query the last payment he made. List four things he could use as a reference number. (4)
8. Oliver wants to check that the VAT calculated on the total amount due is correct. Show how he can do this. Show all your calculations. (3)

[13]

Solutions

1. R99,00 ✓ (1)
2. 02/07/2012 ✓ (1)
3. 31/07/2012 ✓ (1)
4. HSDPA Voice Tariff ✓ (1)
5. VAS Balance Notification ✓ (1)
6. The month of July 2012 ✓ (1)
7. His cell phone number ✓, his account number ✓, the invoice number ✓ and the payment ✓ reference number. (4)
8. Total without VAT = R86,84. ✓ 14% of this = R86,84 ✓ $\times 14 \div 100$
= R12,157 \approx R12,16 ✓ (3)

[13]

3.2 Budgets, income and expenditure statements

A budget is a plan for using income to cover expenses.

Table of some Income and Expenses

INCOME	EXPENSES
<ul style="list-style-type: none"> • Salary – monthly earnings from an employer • Wages – weekly earnings from an employer • Commission – money earned for selling • Profit – extra money gained on sales of goods and services • Gifts • Financial assistance • Rental income for a property 	<ul style="list-style-type: none"> • Living expenses • Accounts • Telephone • Insurance • Personal taxes • Loan repayments • Savings • Salaries and wages • Business running expenses

Types of Income or Expenses:

- **Fixed** means it does not change with time.
- **Variable** means it changes over time, according to the situation.
- **Occasional** means it occurs from time to time.

There are several things you should aim for in your personal budget:

- It should list all of the items that are needed and should try to anticipate unforeseen expenses.
- It should be realistic, so that you can stick to it.
- It should focus on the high priority items (essential items such as food and health care). If too much of the income is spent on non-essential items and not on savings, your budget is going to become problematic in the future.
- An ideal budget should include a plan to save money for the future, or to pay off debts to allow for savings in the following months.
- It should be balanced. If your income is less than your expenses, then you need to revise it until the two sides balance. If your income is more than your expenses, then you should plan to save the extra money.



Worked example 5

Douglas wants to travel from Cape Town to Durban to visit his cousin. His parents said that they can give him R500 towards the trip. He decides to draw up a budget to determine how much money the trip will cost. His uncle has offered to give him a lift home so he only needs to budget for the trip to Durban. He has R2 000 saved in his bank account. He wants to have some spending money left over when he gets there.

He phones Rainbow Buses to find out how much it costs to travel from Cape Town to Durban. They give him two options:

OPTION 1: Leave Saturday morning and travel straight to Durban. The trip costs R1 200 and he will need to pay for 3 meals at R30 per meal.

OPTION 2: Leave Saturday morning and travel to Plettenberg Bay first. The trip costs only R400. He can then catch a bus on Sunday morning to Durban. This bus trip will cost R500. If he does this he needs to find a place to stay on Saturday night and budget for three extra meals (estimated at R30 each). He estimates that a Backpackers' Lodge would be the cheapest place to stay, at R200 a night.

	Income	Expenses	Running total of money that he has
Money from parents			
Savings			
Bus fare			
Meals on bus			
Accommodation			

- a) Copy the above budget sheet and fill in the amounts for income and expenses in the correct columns for Option 1 and Option 2.
- b) Would you advise Douglas to take Option 1 or Option 2? Explain your answer.

Solutions

a) OPTION 1

	Income	Expenses	Running total
Money from parents	500		500
Savings	2 000		2 500
Bus fare		1 200	1 300
Meals on bus		$3 \times 30 = 90$	1 210
Accommodation		0	1 210

OPTION 2

	Income	Expenses	Running total
Money from parents	500		500
Savings	2 000		2 500
Bus fare		$400 + 500 = 900$	1 600
Meals on bus		$6 \times 30 = 180$	1 420
Accommodation		200	1 220

- b) Although the bus fare for Option 2 was cheaper the costs are quite similar in the end. Option 1 is much more convenient and is quicker, so he should choose this option.



Activity 5: Travel budgets

Consider the previous activity, where Douglas planned to travel to Durban. He eventually decided to travel to Durban using bus Option 1. He kept all the receipts and till slips so that he could write a statement to see how much money he actually spent. Read the summary below of Douglas's bus trip.

When Douglas arrives at the bus station to buy the ticket, he finds that the advertised price does not include VAT, and he needs to add 14% to the cost. To add to his problems, the bus breaks down and Douglas needs to find a place to stay the night in Knysna. He finds a backpackers' lodge that costs R200 a night for a shared room. He also needs to rent a locker for R20 to keep his luggage safe. Apart from three meals on the bus, he needs to buy an extra supper and breakfast, which cost him R30 each.

1. Fill in a table like the one used for his budget, to show his actual expenses and the running total of expenses.

Expense description	Amount	Running total of expenses

2. What is the amount of money he ends up with as spending money in Durban?
Remember: he had R2 500 to begin with.

Solutions

1.

Expense description	Amount	Running total of expenses
Bus Fare	R1 200 + R168 VAT	R1 368
Meals on Bus	R90	R1 458
Backpacker's accommodation	R200	R1 658
Locker	R20	R1 678
Meals	$R30 \times 2 = R60$	R1 738

2. He has saved R2 000 and received R500 from his parents.
 $R2\ 500 - R1\ 738 = R762$ to spend in Durban

e.g. Worked example 6

A household has the following monthly expenses:

- rent R2 300
- transport R520
- cell phone R200
- pre-paid electricity R800
- water bill R350
- TV contract R250
- loan repayment R310
- furniture store account R570
- clothing store account R315
- groceries R2 500
- medical expenses R75

They live on the following monthly income: a state pension of R1 140, a disability grant of R1 140 and a salary of R5 250. This month, one of the children falls ill and they have additional medical expenses of R500 for doctor's visits and medication.

- a) Draw up an income and expense statement for the household for this month.
- b) What is the total difference between the income and expenses?
- c) Which costs could be reduced in their budget?
- d) If those costs were reduced, would the family have enough money to cover their expenses?

Solutions

a)

	Income	Expenses
State Pension	1 140	
Disability grant	1 140	
Salary	5 250	
Rent		2 300
Transport		520
Cell phone		200
Pre-paid electricity		800
Water bill		350
TV contract		250
Loan repayment		310
Furniture store account		570
Clothing store account		315
Groceries		2 500
Medical expenses		75 + 500 = 575
Total	7 530	8 690

- b) $R8\ 690 - R7\ 530 = R1\ 160$ more for expenses than they receive in income.
- c) Water and electricity usage could be reduced, the furniture and store accounts could be paid off and closed, and grocery expenses could be reduced.
- d) Probably. They aren't thousands of rands over budget so a series of small reductions across their expenses would bring their expenses in line with their income.



Activity 6: Family budget

Look at the family budget for the month of December 2013, for the Philander family. There are two adults and two school children in the family.

Item	Expenditure		Income
	Fixed	Variable	
Mrs Philander's salary			R9 500
Mr Philander's salary			1.
Additional income			2.
Bond repayment	3.		
Food		4.	
Edgars clothing account	5.		
School fees	6.		
Transport		7.	
Entertainment		8.	
Savings	9.		
Car repayment	R1 300		
Municipality rates	10.		
Electricity	R200	11.	
Vodacom contract cost	R700		
Total	?	?	?
Surplus or deficit?			

Complete the above family budget by using the following information.

- Mr Philander's income: He works 20 days per month at a rate of R500 per day. (1)
- Additional income: Mr Philander owns additional property which he rents out to people at a fixed charge of R2 500 per month. (1)
- The monthly bond repayments are fixed at R5 550 per month. (1)
- The average amount spent on food each month comes to R2 500. Mrs Philander believes that this should be increased by 10% due to recent food price increases. (1)
- Mr Philander pays Edgars an amount of R800 per month. However, since he bought his children their school uniforms on account, he estimates that this amount will increase by a further 12%. (1)

6. The school fees are R1 200 per child per month. (1)
7. Transport costs are as follows: For the children, taxi fare per child = R5,00 per trip to school and another R5,00 each for the trip home. There are 20 school days in a month. Mr Philander first drives his wife to work and then goes to work himself. In the evenings he picks her up and they drive home again. They both work 20 days per month. Mr Philander has noticed that his car uses an average of 4 litres of petrol per day each time he does this. On the other 10 days of the month, his car uses an average of 3 litres per day. The cost of petrol is R10,50 per litre. Calculate the total amount that should be budgeted for transport. (5)
8. The amount budgeted for entertainment is estimated at 5% of the combined income of Mr and Mrs Philander. (2)
9. Savings are currently 5% of Mrs Philander's income. (2)
10. The amount budgeted for municipal rates is 5% of the total income earned by the Philander household. (5)
11. The fixed component of the electricity account is currently R200 per month. The variable component is calculated as follows: the average amount of electricity consumed by the Philander household is 550 kilowatt hours per month at a rate of R0,50 per kilowatt hour. (4)
12. Is the Philander family within budget? Explain your answer. (5)
- [29]

Solutions

1. $20 \times R500 = R10\ 000$ ✓ (1)
2. R2 500 ✓ (1)
3. R5 500 ✓ (1)
4. $R2\ 500 + R250 = R2\ 750$ ✓ (1)
5. $R800 + R96 = R896$ ✓ (1)
6. $R1\ 200 \times 2 = R2\ 400$ ✓ (1)
7. Taxi fare: $R10$ per day \times 2 children \times 20 days ✓ = R400. ✓
 Petrol: $(20 \times 4 \text{ litres} \times R10,50)$ ✓ + $(10 \times 3 \text{ litres} \times R10,50)$ ✓ = R1 555 ✓ (5)
8. Total salaries = R19 500. ✓ 5% of this is R975. ✓ (2)
9. 5% of R9 500 ✓ = R475. ✓ (2)
10. Total income = salaries ✓ + additional income ✓ = R19 500 + R2 500 ✓ = R22 000. ✓ 5% of this is R1 100. ✓ (5)
11. $550 \times R0,50$ ✓ = R275; ✓ monthly is R275 ✓ + R200 = R475. ✓ (4)
12. The total for fixed expenses is R12 621 ✓. The total for variable expenses is R5 755 ✓. So, the total for all expenses is R18 376. The total income for the household is R22 000, so yes – they are within budget ✓, because their income is greater than their total ✓ expenditure and they have a surplus of money. ✓ (5)

[29]

3.3 Banking, interest and tax

Banks offer different types of accounts and services.

- **Savings account:** A bank account that earns interest. You can use a savings account for short – term savings.
- **Cheque or current account:** A bank account that is used to deposit and withdraw money by visiting the bank branch, using an ATM or Internet banking or by writing a cheque. These are usually available to people who earn a regular income.
- **Fixed deposit account:** This account is aimed at those who have a lump sum they want to invest over a fixed period of time (i.e. a medium or long term saving). Interest is also earned on the investment.
- **Credit account (with credit card):** An account either with a store or bank, that allows the account holder to purchase items now and pay for them later.
- **Debit account (with debit card):** Debit cards can be used to pay for purchases. When it's swiped, money is deducted from the account. Credit is not available on this account.

3.3.1 Bank statements

A bank statement is usually sent to the account holder monthly. Bank statements show the following for each transaction:

- the date of the transaction
- a description of the transaction, showing the type of transaction
- the amount of the transaction, indicating whether it is a debit or credit (often in different columns)
- a column for the balance after each transaction.

Account holder: The person whose name the account is in.

Opening and closing balance: The amount of money in the account at the beginning and the end of the period.

Transaction: Any event where money moves into or out of an account.

Debit transaction: Amount of money paid out of an account.

Credit transaction: Amount of money deposited into an account.



Worked example 7

Xola receives the following statement from her bank, detailing her transactions from 25/01/2013 to 20/02/2013. Study the statement and answer the questions that follow.

Date	Description	Amount	Amount	Balance
25/01/2013	Salary	8 000,00		8 050,50
27/01/2013	Car insurance		-100,00	7 950,50
01/02/2013	Electronic transfer Mr. Serei (RENT)		-3 000,00	4 950,50
01/02/2013	Debit order Healthsaver medical aid		-500,00	4 450,50
02/02/2013	Debit order Mobi contract		-250,00	4 200,50
03/02/2013	Debit order Supa Fashion Store		-300,00	3 900,50
05/02/2013	Purchase at Shop 'n Save		-2 000,00	1 900,50
14/02/2013	PAYMENT Mrs. S Khumalo	500,00		2 400,50
20/02/2013	Automechanix		-1 000,00	1 400,50
Total remaining:				1 400,50

- How can you tell the difference between the debits and the credits in this statement?
- List Xola's debits and credits for the month.
- In the first line of this statement, Xola receives a salary of R 8 000. Look at the balance and work out what she had in the account before the payment was made.
- Xola receives some birthday money as well as her salary this month. Identify and write down the birthday transaction.
- How much money would she have been left with on 20/02/2013, if she hadn't received money for her birthday?
- Xola wants to save 15% of her remaining money this month. How much can she save?

Solutions

- The credits are positive values and are in the left-hand column, while the debits are negative and are in the right-hand column.
- Credits: Salary, deposit from Mrs S Khumalo. Debits: car insurance, rent, medical aid, cell phone contract, clothing store account, groceries, car repair.
- $R\ 8\ 050,50 - R\ 8\ 000 = R\ 50,50$, so she had R 50,50 in her account before her salary was paid.
- 14/02/2103 PAYMENT Mrs S Khumalo R 500.
- $R\ 1\ 400,50 - R\ 500 = R\ 900,50$.
- $15\% \text{ of } R\ 1400,50 = 1400,50 \times 0,15 = R\ 210,08$.



Activity 7: Bank statements

Below is an incomplete bank statement for Koketso's savings account at the end of March.

Date	Transaction	Payment	Deposit	Balance
27/02/2013	OPENING BALANCE			2 304,85
01/03/2013	INTEREST ON CREDIT BALANCE		13,95	
01/03/2013	CHEQUE (SALARY)		2 100,00	
01/03/2013	ATM CASH	400,00		
05/03/2013	ATM CASH	800,00		
10/03/2013	ATM DEPOSIT		600,00	
22/03/2013	SPENDLESS DEBIT CARD PURCHASE	235,95		

- How can you tell the difference between the debits and the credits in this statement? (2)
- Copy Koketso's statement and complete the balance column as a running total. (6)
- What is Koketso's balance on the 22nd of March? (1)
- Koketso aims to keep a minimum balance of R2 500 in his account to earn interest. Is he succeeding? (1)

[10]

Solutions

- As payments (debits) ✓ and deposits (credits) ✓ respectively. (2)

2.

Date	Transaction	Payment	Deposit	Balance	
27/02/2013	OPENING BAL			2 304,85	
1/03/2013	INTEREST ON CREDIT BALANCE		13,95	2 318,80	✓
1/03/2013	CHEQUE (SALARY)		2 100,00	4 418,80	✓
1/03/2013	ATM CASH	400,00		4 018,80	✓
5/03/2013	ATM CASH	800,00		3 218,80	✓
10/03/2013	ATM DEPOSIT		600,00	3 818,80	✓
22/3/2013	SPENDLESS DEBIT CARD PURCHASE	235,95		3 582,85	✓ (6)

- R3 582,85 ✓ (1)
- He has succeeded since the beginning of March. ✓ (1)

[10]

3.3.2 Banking fees

Banks charge fees for the services they provide.



Worked example 8

Arthur's bank, Egoli Bank lists the following banking fees.

Arthur subscribes to self-service banking and pays a monthly maintenance fee. In the space of a month Arthur performs the following transactions:

TRANSACTION	FEE
MONTHLY FEES	
Monthly maintenance fee	R5,00
Self-service banking subscription fee	R15,00
DEPOSITS	
Cash (over the counter/at Egoli Bank ATM)	R5,00
Cheque (over the counter/at Egoli Bank ATM)	Free
CASH WITHDRAWALS	
Over the counter	R10,00
Egoli Bank ATM	R5,00
Another bank's ATM	R7,00
Tillpoint - cash only	R1,00
Tillpoint - cash with purchase	R2,00
ACCOUNT PAYMENT AND PURCHASES	
Electronic transfers between accounts	Free
Electronic account payment	Free
Stop order	R5,00
Debit order - internal	R2,50
Debit order - external	R5,00
BALANCE ENQUIRIES	
Over the counter	First free per month, then R10,00
Egoli Bank ATM	First free per month, then R1,00
Another bank's ATM	R2,00
Self-service banking	Free

- He deposits R335,00 in cash at an Egoli Bank ATM.
- He withdraws R500 cash at another bank's ATM.
- He withdraws R100 cash over the counter at an Egoli Bank branch.
- He enquires twice about his balance, over the counter at an Egoli branch.
- He draws cash, whilst buying groceries at a till point at his local supermarket.
- He makes 3 electronic account payments to pay his rent, electricity and phone bill.

1. Calculate the total bank charges for these transactions.
2. Arthur has a balance of R650 in his bank account at the end of the month.
 - (a) Calculate the ratio of the total bank fees to the month end balance.
 - (b) Express this ratio as percentage. (Round off your answer to 1 decimal place.)
3. Suggest ways in which Arthur could reduce his banking fees.

Solutions

1. R5,00 (Monthly maintenance fee) + R15,00 (self-service banking) + R5,00 (cash deposit at Egoli bank) + R7,00 (cash withdrawal at other bank) + R10,00 (cash withdrawal over the counter) + R0,00 (first balance enquiry) + R10,00 (second balance enquiry) + R2,00 (till point cash withdrawal) + (3 × R0,00) (free electronic account payments) = R54,00.
2. (a) Banking fees: closing balance = 54 : 650 or 27 : 325
 (b) $54 \div 650 \times 100 = 8,3\%$ or $27 \div 325 \times 100 = 8,3\%$
3. Arthur could withdraw cash at Egoli Bank ATM's only, not at other banks' ATM or over the counter at a bank branch. He could ask for a balance enquiry from an Egoli ATM, or via self-service banking, instead of over the counter. He could withdraw cash only at a till point, without purchasing anything.



Activity 8: Calculating banking fees

Mia has recently opened a Global account at Capital Bank. She is concerned about her monthly bank charges. Use the provided brochure and list of her account activities for the month of April to answer the questions below.

Date	Activities	Amounts
01 April 2013	Balance of previous month carried forward	R210,25
01 April 2013	Old Mutual Policy x74534: Debit order returned: insufficient funds*	R254,39
01 April 2013	Balance enquiry (mobile)	R0,00
02 April 2013	Davidsons Textiles: Salary deposit*	R450,00
02 April 2013	Shoprite Purchases: debit card*	R847,21
02 April 2013	Shoprite: Cash withdrawal*	R250,00
07 April 2013	Old Mutual Policy x74534: Branch Payment	R254,39
15 April 2013	Edgars: Purchases: Debit card*	R149,59
20 April 2013	Capital Bank ATM Withdrawal: *	R200,00
23 April 2013	Shoprite: municipal account payment*	R639,00
28 April 2013	FNB ATM withdrawal*	R500,00
29 April 2013	Balance statement at the branch	R3,00
30 April 2013	Monthly admission fee	R4,50

TRANSACTION	FEE
Monthly fees	
Monthly administration fee	4.50
Mobile banking subscription	FREE
Internet banking subscription	FREE
Cash withdrawals	
Supermarket tillpoints	1.00
Capital bank ATM	4.00
Other ATM	7.00
Balance enquiries	
Mobile banking	FREE
Cashier	FREE
Capital Bank ATM	FREE
Other ATM	4.00
Transfers/Payments/Purchases	
Debit card purchase	FREE
Debit order/recurring payment at branch	3.00
Debit order/recurring payment with internet banking	1.50
Payment to other Capital Bank account at branch	3.00
Payment to other Capital Bank account with internet banking	1.50
Other	
SMS notification	0.40
Statement in branch	3.00
Create, change or cancel recurring payment at branch	4.00
Returned debit order/recurring payment (stop order)	4.00
Returned early debit order	FREE
Insufficient funds (other ATM)	4.00

*denotes SMS notification for April

- How many withdrawals did Mia make during this month? (1)
- Calculate the amount of money that was spent on monthly shopping purchases. (1)
- Use the relevant resources to calculate the amount of bank fees that Mia will pay for April. (9)
- Suggest how Mia can further reduce her banking charges. (3)

[14]

Solutions

- Three. ✓ (1)
- $R847,21 + R149,59 = R996,80$ ✓ (1)
- Returned debit order R4,00 ✓. Cash withdrawal at Shoprite: R1,00 ✓. Old Mutual debit order payment at branch: R3,00 ✓. Capital Bank ATM withdrawal: R4,00 ✓. FNB ATM withdrawal: R7,00 ✓. Balance statement in branch: R3,00 ✓. Monthly admin fee: R4,50 ✓. 8 SMS notifications: R3,20 ✓. Total: R29,70 ✓. (9)
- She could do away with SMS notifications ✓, only draw cash at till points ✓ and make sure that her debit orders ✓ don't get returned. (3)

[14]

3.3.3 Simple interest

Interest rate: A **percentage** charged for the borrowing, or loan, of a sum of money over a given period of time.

Interest: The amount of money that you are charged (by the lender of money, e.g. the bank) for borrowing an amount of money, over a period of time.

Simple interest is calculated on the original amount, and is the same each time it is paid.

Calculating interest amounts and interest rates

If we know what the interest rate is, we can calculate the interest value quite simply. For example, 10% interest on R3 500 = $R3\ 500 \times 10\% = R350$. So the interest amount is R350 and the total amount is $R3\ 500 + R350 = R3\ 850$.

If you are given the final amount, then you follow these steps to find the interest rate:

- Find the difference between the final amount and the original amount: this gives you the amount of interest.
- Work out what percentage the amount of interest is of the original value, or of the amount owed (in hire purchase).



Worked example 9

You see an advert for a wall unit. The cash price of the wall unit is R6 499,99. Alternatively, you could choose to buy it on hire purchase and pay for it in instalments over 3 years. If you choose to pay it off in instalments, you will pay interest every month on the wall unit.

- Calculate what the wall unit will cost if you pay a cash deposit of R650, and 36 monthly instalments of R449 each. (The total = cash deposit + 36 monthly instalments.)
- Calculate how much interest you will pay in total (in Rands) if you pay off the wall unit in instalments. (Hint: Interest amount = total payments – cash price.)
- Calculate the interest rate. (Interest rate = $(\text{Interest} \div \text{money owed}) \times 100$).
- Do you think it is better to save up and buy the wall unit at the cash price, or pay it off over 3 years? Explain your answer.

Solutions

- Total = cash deposit + 36 monthly instalments = $R650 + (R449 \times 36 \text{ months}) = R16\ 814$.
- Interest = total payments – cash price = $R16\ 814 - R6\ 499,99 = R10\ 314,01$.
- You owe $R6\ 499,99 - R650 = R5\ 849,99$. Interest rate = $(R10\ 314,01 \div R5\ 849,99) \times 100 = 176,3\%$ over 3 years which is 58,8% per annum.
- It is much cheaper to save up and buy the wall unit at the cash price. Over three years, the total amount you would pay in instalments is almost three times the cash price.



Activity 9: Simple Interest

You found the following advertisement in a local newspaper. Answer the questions below.

ON SALE!

Limited stocks in five different colours!



40-inch Plasma TV set

Cash price: R15 600

Or: monthly instalments of R356,24 over 5 years

Deposit: R1 560

- Does the advertisement indicate the percentage of interest that will be charged if the TV is not paid for in cash? (1)
- What will the balance be once the deposit has been paid? (4)
- Will the interest be charged on the full purchase price or on the balance? (1)
- How much will the instalment be per month? (1)
- How much will you have to pay for the TV in total?
Use the formula:
Total to be paid = Deposit + (Instalment x number of instalments) (6)
- How much interest (in Rands) will you have paid once you have completed paying off the TV? Use the formula:
Interest = Total paid – cash price. (3)
- What simple interest rate per annum will you be paying on the outstanding balance? (4)

[20]

REMEMBER:

You calculate the interest rate on the money that you owe after you pay the deposit.

Solutions

- No. ✓ (1)
- Balance = Cash price ✓ – Deposit ✓ = R15 600 – R1 560 ✓ = R14 040. ✓ (4)
- It will be charged on the account balance. ✓ (1)
- R356,24. ✓ (1)
- Total Payable = Deposit + (Instalment amount × number of instalments)
= R1 560 ✓ + [R356,24 ✓ × (12 × 5)] ✓ = R1 560 ✓ + R21 374,40 ✓
= R22 934,40. ✓ (6)
- Interest = total paid – cash price
= R22 934,40 ✓ – R15 600 ✓ = R7 334,40 ✓ (3)
- $R7\,334,40 \div R14\,040 \times 100\% = 52,24\%$ ✓ over 5 years, which is 10,45% ✓ p.a. (4)

[20]

3.3.4 Compound interest

- Compound interest is calculated on the current balance.
- It yields more interest over time than simple interest.



Worked example 10

Mr. Moloke has two options for borrowing money.

- His uncle has offered to lend him R16 000 for five years at 18% per annum, simple interest.
- His personal bank will lend him R16 000 for five years at 16% interest compounded per annum.

Determine the cost of the two options to recommend which one would be best for Mr. Moloke.

Solutions

a) Simple interest = $R16\ 000 \times 18 \div 100 \times 5 = R14\ 400$

Total amount = $R14\ 400 + R16\ 000 = R30\ 400$

b) Compound interest

First year = $R16\ 000 \times 16 \div 100 = R2\ 560$

Total = $R2\ 560 + R16\ 000 = R18\ 560$

Second year = $R18\ 560 \times 16 \div 100 = R2\ 969,60$

Total = $R2\ 969,60 + R18\ 560 = R21\ 529,60$

Third year = $R21\ 529,60 \times 16 \div 100 = R3\ 444,74$

Total = $R3\ 444,74 + R21\ 529,60 = R24\ 974,34$

Fourth year = $R24\ 974,34 \times 16 \div 100 = R3\ 995,89$

Total = $R3\ 995,89 + R24\ 974,34 = R28\ 970,23$

Fifth year = $R28\ 970,23 \times 16 \div 100 = R4\ 635,24$

Total = $R4\ 635,24 + R28\ 970,23 = R33\ 605,47$

Therefore the personal loan is cheaper.

3.3.5 Loans

People borrow money when they need it most and they have to pay interest on the borrowed amount.



Worked example 11

The table below is an extract from a letter from Sanlam to Mr. Moloke. It shows the amounts that are available on instant loan from Sanlam and the repayment involved.

Dear Mr. Moloke

As a valued customer, we are pleased to be able to offer you a personal loan at the following rates.

Loan amount	24 months	36 months	48 months	60 months
R4 000	R229	R174	R147	R131
R8 000	R448	R338	R285	R253
R16 000	R864	R643	R534	R470
R25 000	R1 344	R1 000	R830	R730

These loan repayments include a monthly premium of R3,95 per R1 000 of the loan and a monthly administration fee of R9,50 for your optional personal protection plan.

Answer the following questions.

If Mr. Moloke chooses to borrow R16 000 from Sanlam, calculate how much he will finally repay if he takes the loan over:

- 24 months
- 60 months.

Do you advise him to borrow for a longer or shorter time?

Solutions

- $24 \times R864 = R20\ 736$
- $60 \times R470 = R28\ 200$

Borrowing for a short time involves less interest.



Activity 10: Loans

Mosima wants to buy an LCD TV and saw it advertised at R25 000. She does not have enough money to pay cash for the TV, so she has the option of either taking a loan from a microlender or paying by means of an instalment sale (hire purchase) agreement.

Suppose Mosima borrows R25 000 from a microlender to pay for the TV. The amount she has to repay every month depends on the length of time she takes to repay the loan. The table below shows the different options she can choose from.

	Number of monthly instalments				
	12	18	24	36	42
Loan amount	R25 000	R25 000	R25 000	R25 000	R25 000
Initiation Fee	R1 140	R1 140	R1 140	R1 140	R1 140
Monthly Admin. Fee	R57	R57	R57	R57	R57
Monthly Instalment	R2 283	R1 875	R1 562,50	R1 145,83	A
Total Amount paid by the end of loan period	R29 220	R35 916	R40 008	R44 441	R48 534,06

NOTE:

- An initiation fee is the amount charged by the microlender to process the loan application and is payable when the loan has been approved.
- A monthly instalment is the amount paid monthly.
- A monthly administration fee is an additional cost that is added to the monthly instalment.
- The total amount to be repaid = Initiation fee + [no. of instalments × (monthly instalment + admin fee)].

1. Use the formula to calculate the missing value A. (2)
2. Suppose Mosima chose to repay the loan over 42 months. How much will the loan cost her in total? (1)
3. If she buys the TV at R25 000 by means of an instalment sale agreement, she must first pay a 10% deposit, and then pay off the balance owing in equal instalments over 24 months at 33% per annum simple interest. Calculate the amount she has to pay for the deposit. (1)
4. Calculate the amount she is required to pay for her equal monthly instalments. Use the formula:
(balance owing × interest × no. of years) ÷ 24. (2)
5. Calculate the total cost of the TV if she used this method of payment. (3)
6. Mosima decides that she wants to pay for the TV over a period of 24 months.
Why? (1)

[10]**Solutions**

1. $R48\,534,06 - R1\,140 = R47\,394,06$ over 42 months. ✓
Divide by 42 and subtract R57 to get $A = R1\,071,43$. ✓ (2)
2. $R48\,534,06$ ✓ (1)
3. $R2\,500$ ✓ (1)
4. $(R22\,500 \times 0,33 \times 2) \div 24$ ✓
 $= R618,75$ ✓ (2)
5. $R2\,500$ ✓ + $(24 \times R618,75)$ ✓ = $R17\,350$. ✓ (3)
6. It costs less in total. ✓ (1)

[10]

3.4 Inflation

Inflation is the increase of the price of a typical basket of goods and services calculated over a period of time.

Inflation rate is calculated as a percentage.



Worked example 12

- a) A litre of milk currently costs R9,11. The expected inflation rate for 2015 will be 6,5%. What will the price of the milk be in 2015?

Solution

$$\begin{aligned} \text{New price will be} &= 9,11 + 6,5\% \times 9,11 \\ &= 9,11 + (6,5/100 \times 9,11) \\ &= 9,11 + 0,6 \\ &= \text{R}9,71 \end{aligned}$$

- b) The price of Nike shoes in 2014 is R650,95. What was the price of Nike shoes in 2013, if the inflation rate for 2013 was 6,4%?

Solution

$$\begin{aligned} \text{Inflation value} &= 650,95 \times 6,4/106,4 & \text{OR} & \text{Previous price} + 6,4\% = \text{R}650,95 \\ &= \text{R}39,15 & & \text{Prev. price} + (\text{prev. price} \times 0,064) \\ & & & = \text{R}650,95 \end{aligned}$$

$$\begin{aligned} \text{Therefore, Previous price} & & & \text{Prev. price} (1 + 0,064) = \text{R}650,95 \\ &= \text{R}650,95 - \text{R}39,15 & & \text{Prev. price} = \text{R}650,95 \div 1,064 \\ &= \text{R}611,80 & & = \text{R}611,80 \end{aligned}$$

- c) A box of jungle oats increases in price from R17,99 to R19,99. Calculate the inflation rate for this period. Use the formula:

$$\text{Inflation rate} = \frac{\text{current price} - \text{previous price}}{\text{previous price}} \times 100\%$$

Solution

$$\begin{aligned} \text{Inflation rate} &= \frac{19,99 - 17,99}{17,99} \times 100\% \\ &= 11,1\% \end{aligned}$$



Activity 11: Inflation

1. A bar of soap currently costs R8,51 in 2014. The expected inflation rate for 2015 will be 6,3%. What will the price of the soap be in 2015? (2)
2. The price of a dress is R1 300,95 in 2014. What was the price of the dress in 2013, if the inflation rate for 2013 was 6,5%? (4)
3. A set of chairs increases in price from R17 355,75 to R19 943,99. Calculate the inflation rate for this period.

$$(\text{Inflation rate} = \frac{\text{current price} - \text{previous price}}{\text{previous price}} \times 100\%) \quad (3)$$

4. In November 2009 Statistics SA announced that the annual inflation rate was 5,8%.
 - a) Determine the price of a bicycle in November 2008 if it cost R1 586,95 in November 2009. (4)
 - b) Calculate the projected cost of a loaf of bread in November 2014 if it cost R5,45 in November 2008. Assume that the annual inflation rate remained at 5,8% over the given period. You may use the formula

$$A = P(1 + i)^n \quad (2)$$

where

A = the projected cost

P = current cost.

i = the annual inflation rate.

n = number of years.

[15]

Solutions

1. Current cost = R8,51 × 106,3% ✓ = R9,05 ✓ OR (2)
 $R8,51 \checkmark + (R8,51 \times 6,3 \div 100) = R8,51 + R0,54 = R9,05 \checkmark$
2. Inflation Value = R1 300,95 × 6,5 ÷ 106,5 ✓ = R79,40 ✓
 Previous price = R1 300,95 ✓ – R79,40
 = R1 221,55 ✓
 OR
 $R1\ 300,95 \checkmark \div 1,065 \checkmark \checkmark = R1\ 221,55 \checkmark$ (4)
3. Inflation rate = (R19 943,99 – R17 355,75) ✓ ÷ R17 355,75 ✓ × 100
 = R2 588,24 ÷ R17 355,75 × 100% = 14,91% ✓ (3)
4. a) Price of bicycle ✓ × 105,8% = R1 586,95 ✓
 Price of bicycle = R1 586,95 ✓ ÷ 105,8% = R1 586,95 ÷ 1,058 = R1 499,95 ✓ (4)
- b) A = P (1 + i)ⁿ
 A = 5,45 (1 + 0,058)⁶ ✓
 = R7,64 ✓ (2)

[15]

3.5 Payslips, deductions and tax

PAYE on a payslip stands for “pay as you earn”. This is the income tax that is deducted directly from your salary every month. PAYE is compulsory for all employees. It is calculated according to a set percentage based on your gross annual income. Tax is collected by the South African Revenue Service (SARS).

UIF stands for “Unemployment Insurance Fund”. It serves as a form of insurance, so that if you lose your job, you may apply for UIF which is a small monthly payout from the government. Employers must pay 2% of each employee’s monthly pay towards UIF. The employees and the employer each contribute 1%.

Depending on your employer, you may be a member of a company pension fund or medical aid.

How is my tax rate calculated, and do I qualify for any rebates?

There are set tax thresholds, which are maximum amounts that you can earn before you are required to pay tax. In South Africa, the highest tax rate is 40%, which applies to individuals earning R638 601 and above per annum. The tax tables themselves are a little more complicated than this, but this will suffice for the purpose of understanding your payslip.

These are adjusted every year and the new tables are announced with the budget. The tax thresholds for individuals for the 2013/14 financial year are:

- individuals younger than 65: R67 111
- individuals aged 65–75: R104 611
- individuals older than 75: R117 111.

Individuals receive standard tax rebates calculated according to age. A tax rebate is an amount of tax by which the total tax due is reduced. In other words, tax rebates reduce the amount of tax you have to pay. The age categories are the same as for tax thresholds, and are known as primary (younger than 65), secondary (65 – 75) and tertiary (older than 75) rebates. They are as follows:

- Primary: R12 080
- Secondary: R6 750
- Tertiary: R2 250



Worked example 13

Company Name

1 Money Road, Cashville, 1000

Payslip date : 01/01/2013	Payslip No. : 01
Empl no. : 01	App. Date : 01/01/2012
Name : 0000001	I.D. Number : 7001120101015
Full name : Joe Bloggs	Bank Code : 100100
Paypoint :	Bank A/c No : 1001001001
Cost Centre :	Job Grade :
Job Title : Bookkeeper	

EARNINGS	DAYS/HOURS	AMOUNT	DEDUCTIONS	AMOUNT	BALANCE
Basic Pay	21.67	10000.00	P.A.Y.E	793.33	
			U.I.F.	100.00	
-----			-----		
Totals:	21.67	10000.00		893.33	
-----			-----		

Nett Amount: 993.33

Company : Company Name	Empl No. : 01
Name : Bloggs Joe	I.D. Number : 700110101015
Date : 01/01/2013	App. Date : 01/01/2012
Bank Name : Joe's Bank	Bank A/c : 1001001001
Address : 1 Bloggs Street Cashville 1000	

Accumulated Totals	Ytd Value	Other	Ytd Value
Gross Remuneration	120000.00	Pay Rate	10000.00
Tax Deducted	9520.00	TAXABLE EARNINGS	120000.00

Use the above payslip, and the information on tax to answer the following questions.

- Calculate the daily earnings of Mr. Bloggs.
- (i) How is the amount of UIF calculated?
(ii) How much does the company pay toward UIF?
- How is the amount of the PAYE calculated?

Solutions

- Earnings per day = $R10\ 000 / 21,67 = R461,47$
- (i) 1% of salary, i.e. 1% of R10 000 = R100
(ii) R100
- In the example above, Joe Bloggs pays R793,33 PAYE per month. Here's how that figure was calculated:

Joe Bloggs falls into the 18% tax bracket, as he earns less than R165 600 per year.

Gross annual income (R120 000) x tax rate (18%)	R21 600
Minus deductions (primary rebate)	– R12 080
Subtotal (total tax due per annum)	= R9 520
TOTAL (subtotal divided by 12 months)	R793,33



Activity 12: Payslips, deductions and tax

Study the payslip below and answer the questions.

FASHION DIVA			
NAME: Lucinda Adams		Payslip nr. 009	Pay date: 25 August 2013
ADDRESS: 4 Arcade Ave Kriel		BANK DETAILS: ASBA bank Cheque account 19056634486	
INCOME		DEDUCTIONS	
Basic salary:	R15 780	PAYE/TAX	R2 865,83
Overtime: (38 hrs @ R85 p/h)	____(a)	Medical Aid: UIF (1% of basic salary)	R1 420 ____ (b)
		Pension fund (of the amount paid to medical aid fund)	____(c)
Total income: ____ (d)		Total deductions: ____ (e)	
Net pay (Income – Deductions): ____ (f)			

- Calculate the missing values in order to complete the payslip. (6)
- Lucinda sees that R2 865,83 was deducted from her salary for PAYE (also known as personal tax). Use the table and example below to show that the amount was calculated correctly. (8)

INCOME TAX FOR INDIVIDUALS for the tax year 2011/2012	
TAXABLE YEARLY INCOME (R)	RATE OF TAX (R)
0 – 160 000	18% of each R1
160 001 – 250 000	28 800 + 25% of taxable income above R160 000
250 001 – 364 000	51 300 + 30% of taxable income above R250 000
364 001 – 484 000	81 100 + 35% of taxable income above R364 000
484 001 – 617 000	128 400 + 38% of taxable income above R484 000
617 001 and above	178 940 + 40% of taxable income above R617 000
TAX REBATES:	Primary rebates – R11 440 Secondary Rebates (persons 65–75 years) – R6 390 Tertiary Rebates (persons 75 years and older) – R2 130
TAX THRESHOLD:	Below age 65 years – R63 550 Age above 65 years to below 75 – R99 056 Age above 75 years and older – R110 889
EXAMPLE	R556 444 (yearly salary) R128 400 + 38% of amount above R484 000 (R556 444 – R484 000) = R128 400 + 38% × R72 444 = R155 928,72 – R11 440 = R144 488,72 (yearly tax) ∴ R12 040,73 (monthly tax)

- Lucinda wants to buy a coat from Fashion Diva. The coat costs R749 including VAT. As she is an employee of the shop, the owner gives her a discount by not charging her VAT (14%) on the coat. Calculate the amount she would have to pay. (2)

[16]

Solutions

1. a) R3 230 ✓
 b) R157,80 ✓
 c) R1 065 ✓
 d) R19 010 ✓
 e) R5 508,63 ✓
 f) R13 501,37 ✓ (6)
2. $R19\ 010 \times 12 = R228\ 120$ ✓
 Therefore = $R28\ 800$ ✓ + $(25\% \times [R228\ 120$ ✓ - $R160\ 000])$ ✓
 = $R28\ 800 + (25\% \times R68\ 120)$
 = $R45\ 830$ ✓
 Less rebate = $R45\ 830 - R11\ 440 = R34\ 390$ ✓
 $R34\ 390 \div 12$ ✓
 = $R2\ 865,83$ ✓ (8)
3. $R749,00 \div 1,14 = R657,02$ ✓✓ (2)

[16]

Measurement

In this chapter learners need to apply some of the skills from Chapter 3, such as changing the subject of a formula and correctly substituting values into a formula. Remember that the units are important when you work with measurements.

4.1 Converting between different units of measurement

4.1.1 Metric conversions

You need to memorise the conversions between metric units.

Length

Conversion factors for length
10 millimetres (mm) = 1 centimetre (cm)
1 000 millimetres (mm) = 1 metre (m)
100 centimetres (cm) = 1 metre (m)
1 000 metres (m) = 1 kilometre (km)

*To convert to a smaller unit, we multiply.
To convert to a larger unit, we divide.*



Here is a visual representation of converting between units of length:

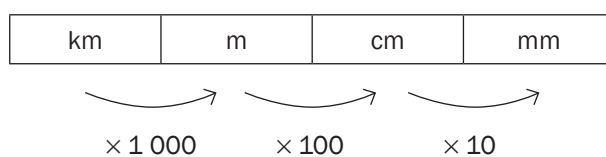

We can also reverse it to find lengths in larger units:

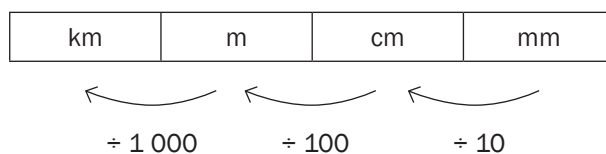

Volume

Conversion factors for volume
1 000 millilitres (mℓ) = 1 litre (ℓ)
1 000 litres (ℓ) = 1 kilolitre (kℓ)

Here is a visual representation of converting between units of volume:

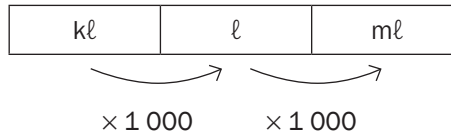

And you can also reverse it:

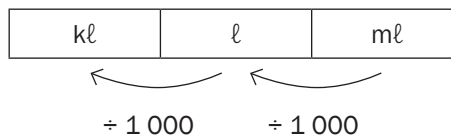
**Weight**

Conversion factors for weight
1 000 mg (mg) = 1 gram (g)
1 000 grams (g) = 1 kilogram (kg)
1 000 kilograms (kg) = 1 tonne (t)

Here is a visual representation of converting between units of weight:

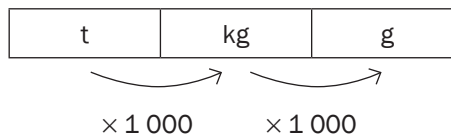

And one can also reverse it:

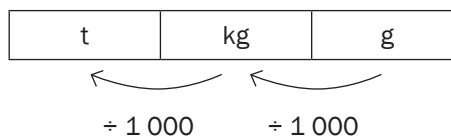



Worked example 1

Convert the following units. Remember to show all of your calculations.

- A leaf is 25 mm long. How long is it in cm?
- A sofa is 187 cm long. How long is it in metres?
- Harry's household uses 1 023 ℓ of water per month. How much water do they use in kℓ?
- A tin contains 3,5 ℓ of paint. How many millilitres of paint is in the tin?
- The cover of a book is 16,2 cm long. How long is the book in mm?
- A medicine tablet weighs 50 mg. How much does the tablet weigh in grams?
- A shopping bag weighs 2 850 g. How heavy is the bag in kg?

Solutions

- Converting to a larger unit, divide by 10: $25 \text{ mm} = 2,5 \text{ cm}$.
- Converting to a larger unit, divide by 100: $187 \text{ cm} = 1,87 \text{ m}$.
- Converting to a larger unit, divide by 1 000: $1\,023 \text{ ℓ} \div 1\,000 = 1,023 \text{ kℓ}$.
- Converting to a smaller unit, multiply by 1 000: $3,5 \times 1\,000 = 3\,500 \text{ mL}$.
- Converting to a smaller unit, multiply by 10: $16,2 \text{ cm} \times 10 = 162 \text{ mm}$.
- Converting to a larger unit, divide by 1 000: $50 \text{ mg} \div 1\,000 = 0,05 \text{ g}$.
- Converting to a larger unit, divide by 1 000: $2\,850 \div 1\,000 = 2,85 \text{ kg}$.



Activity 1: Converting units

Do the conversions.

- | | | | |
|-----|---|---|-----|
| 1. | A tennis court is 23,78 m long. | Convert to cm. | (1) |
| 2. | Thabiso fills a bath with 23,7 ℓ of water. | How much water is this in mL? | (1) |
| 3. | The distance between Cape Town and Betty's Bay is 90,25 km. | How far is this in metres? | (1) |
| 4. | The distance from Phumza's house to the shop is 1 890 000 mm. | How far is this in kilometres? | (1) |
| 5. | A can of cola has a capacity of 330 mL. | How many litres of cola is this? | (1) |
| 6. | A boulder weighs 2,35 t. | Convert the weight of the boulder into grams. | (1) |
| 7. | A book weighs 0,85 kg. | Convert the weight of the book into grams. | (1) |
| 8. | Jack and Thembile live 6 473 m apart. | Convert this distance to km. | (1) |
| 9. | The dam on Cara's farm contains 6,025 kℓ of water. | How much is this in litres? | (1) |
| 10. | A playground is 4,02 m wide. | How wide is the playground in cm? | (1) |
| 11. | A car weighs 1 250 000 g. | What is the mass in tonnes? | (1) |
| 12. | A long workbench is 295 cm long. | How long is it in metres? | (1) |

[12]

Solutions

- | | | | |
|-----|---|---|-----|
| 1. | A tennis court is 23,78 m long. | $23,78 \times 100 = 2\,378 \text{ cm}$ ✓ | (1) |
| 2. | Thabiso fills a bath with 23,7 ℓ of water. | $23,7 \times 1\,000 = 23\,700 \text{ ml}$ ✓ | (1) |
| 3. | The distance between Cape Town and Betty's Bay is 90,25 km. | $90,25 \times 1\,000 = 90\,250 \text{ m}$ ✓ | (1) |
| 4. | The distance from Phumza's house to the shop is 1 890 000 mm. | $1\,890\,000 \div 1\,000\,000 = 1,89 \text{ km}$ ✓ | (1) |
| 5. | A can of cola has a capacity of 330 ml. | $330 \text{ ml} \div 1\,000 = 0,33 \text{ ℓ}$ ✓ | (1) |
| 6. | A boulder weighs 2,35 t. | $2,35 \text{ t} \times 1\,000\,000 = 2\,350\,000 \text{ g}$ ✓ | (1) |
| 7. | A book weighs 0,85 kg. | $0,85 \times 1\,000 = 850 \text{ g}$ ✓ | (1) |
| 8. | Jack and Thembile live 6 473 m apart. | $6\,473 \div 1\,000 = 6,473 \text{ km}$ ✓ | (1) |
| 9. | The dam on Cara's farm contains 6,025 kℓ of water. | $6,025 \times 1\,000 = 6\,025 \text{ ℓ}$ ✓ | (1) |
| 10. | A playground is 4,02 m wide. | $4,02 \times 100 = 402 \text{ cm}$ ✓ | (1) |
| 11. | A car weighs 1 250 000 g. | $1\,250\,000 \div 1\,000\,000 = 1,25 \text{ t}$ ✓ | (1) |
| 12. | A long workbench is 295 cm long. | $295 \div 100 = 2,95 \text{ m}$ ✓ | (1) |

[12]

4.1.2 Cooking conversions and temperature

In recipes used for cooking and baking we often find the measurements for the ingredients required in cups, teaspoons and tablespoons. Measuring cups and spoons come in standard sizes, and are common in the kitchen and in recipes because they are quick and simple to use.

If you don't have measuring spoons and cups, you can use everyday household objects to approximate the same quantity of ingredients. For example, a small tea cup is roughly the same size as a measuring cup and a heaped, normal-sized spoon is about the same quantity as a measuring tablespoon. When following a recipe though, it is important to be as accurate as possible with your measurements, so using these rough approximations is often not suitable.

The following table shows some of the conversions used in cooking:

Conversions for cooking and baking
1 cup = 250 ml
1 tablespoon (tbsp) = 15 ml
1 teaspoon (tsp) = 5 ml

Note: you will be given these conversions in assessments

4.2 Measuring length

Estimation is used to find approximate values for measurements. For example, one metre is approximately the length from your shoulder to your fingertips, if you stand with your arm outstretched. A metre is also approximately the distance of one large step or jump.



Worked example 2

Carl needs to measure the width of a window, to find out how much material he must buy to make a curtain. The curtain material costs R55 per metre on sale, sold only in full metres.

- a) Carl estimates the width of the window to be 1,9 metres wide (using his arm). If Carl goes to the shop with this estimate:
- How many metres of material should he buy?
 - How much would the material cost?
- b) Carl decides to double-check his estimated measurement before he buys the material and so he uses his tape measure to accurately measure the width of the window. He determines that the window is actually 2,2 m wide.
- How many metres of material does he need to buy?
 - How much will the material cost?

Solutions

- a) (i) 2 m
 (ii) $2 \times R55 = R110$
- b) (i) 3 m (as the material is only available in units of 1 metre)
 (ii) $3 \times R55 = R165$



Worked example 3

Liz sews dresses for children. The material costs R89,50 per metre and she needs 2 metres of material to make a dress for a 4 year old; 2,5 metres to make a dress for a 7 year old and 3 metres to make a dress for 10 year old. The embroidery cotton costs R12,55 for a roll of 3 metres. She uses 2 rolls of cotton per dress.

- How many metres of material will she need to make the following four dresses: 1 dress for a 7 year old, 2 dresses for four year olds, and 1 dress for a 10 year old?
- What will the material cost for the four dresses?
- What is the length of embroidery cotton that Liz is going to use when sewing one dress, in metres and centimetres?
- What is the total amount that she will pay for the embroidery cotton?
- What is the total cost of a dress for a 10 year old?

Solutions

- a) $2,5 \text{ m} + 2 \text{ m} + 2 \text{ m} + 3 \text{ m} = 9,5 \text{ m}$
- b) Length of material \times price
 $= 9,5 \text{ m} \times \text{R}89,50$
 $= \text{R}850,25$
- c) Length of one roll of cotton $\times 2 = 3 \text{ m} \times 2$
 $= 6 \text{ m}$, or 600 cm per dress
- d) Number of dresses $\times 2$ rolls of cotton per dress \times price
 $= 4 \times 2 \times \text{R}12,55$
 $= \text{R}100,40$
- e) (Length of material \times price) + (2 rolls of cotton \times price)
 $= (3 \text{ m} \times \text{R}89,50) + (2 \times \text{R}12,55)$
 $= \text{R}268,50 + \text{R}25,10$
 $= \text{R}293,60$

**Activity 2: Measuring length**

Jenny has started a decorating business and has a contract to provide decor at a wedding reception.

- The tables used at this wedding are rectangular with a length of 3 m and a width of 1 m as shown below. The fabric she plans to use for the tablecloth costs R75 per metre (but can be bought in lengths smaller than a metre) and is sold in rolls that are 1,4 m wide. The bride and groom want the tablecloths to hang at least 20 cm over the edges of the tables.
 Calculate the cost of the cloth for each table. (2)
 - If there are 15 tables at the wedding, calculate how much she is going to spend on tablecloths alone. (1)
- [3]

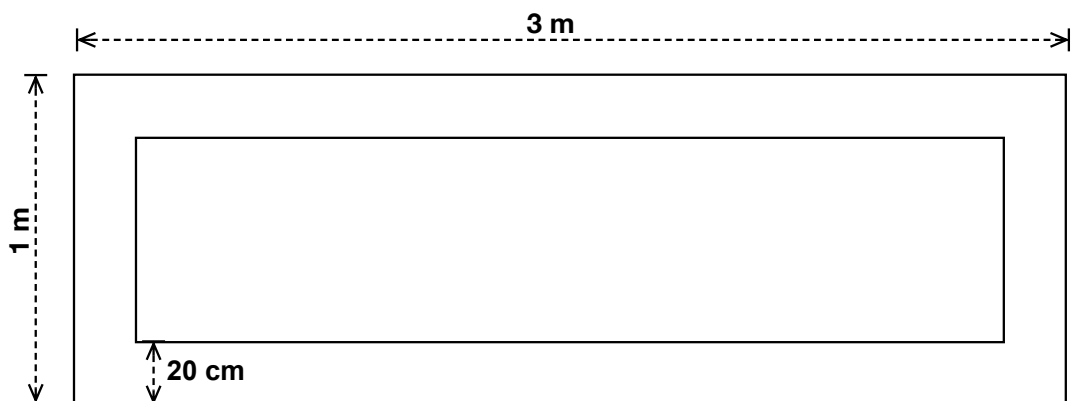
**Solutions**

- $3,4 \times 1,4 \times 75 = (3,4 \times 75) \checkmark$ in 1,4 m width = R255,00 \checkmark (2)
 - R3 825,00 \checkmark (1)
- [3]

4.3 Measuring mass or weight

- The scientific word for how much an object weighs on a scale is “mass”.
- In this book we will use the words “weight” and “mass” interchangeably, because both are used in everyday language.



Worked example 4

- a) A lift in a shopping mall has a notice that indicates that it can carry 2,2 tonnes or a maximum of 20 people. Convert the tonnes measurement to kilograms and work out what the engineer who built the lift estimated the average weight of a person to be.
- b) A long distance bus seats 50 passengers and allows each passenger to each have luggage of up to 30 kg.
- (i) If 50 people, with average weight of 80 kg per person, each have one piece of luggage that weighs an average of 29 kg, what would be the total load carried by the bus, in tonnes?
- (ii) If the bus weighs 4 tonnes, how much does it weigh in total (in kg) including all the passengers and the luggage?
- c) Sweet Jam can be bought in bulk from a warehouse in boxes that contain 25 tins of 250 g each.
- (i) Calculate the total weight of the jam in each box, in kg.
- (ii) If a trader orders 15 boxes of Sweet Jam, calculate the total weight of his order in kg.

Solutions

- a) $2,2 \text{ t} = 2\,200 \text{ kg}$. $2\,200 \text{ kg} \div 20 \text{ people} = 110 \text{ kg}$ each
- b) (i) $(50 \times 80 \text{ kg}) + (50 \times 29 \text{ kg})$
 $= 4\,000 \text{ kg} + 1\,450 \text{ kg}$
 $= 5\,450 \text{ kg}$
 $= 5,45 \text{ t}$
- (ii) $4 \text{ t} = 4\,000 \text{ kg}$. $4\,000 \text{ kg} + 5\,450 \text{ kg} = 9\,450 \text{ kg}$
- c) (i) $250 \text{ g} \times 25$
 $= 6\,250 \text{ g}$
 $= 6,25 \text{ kg}$
- (ii) $15 \text{ boxes} \times 6,25 \text{ kg} = 93,75 \text{ kg}$



Activity 3: Measuring weight

You should never carry more than 15% of your body weight. Elias weighs 66 kg and his backpack, with school books, weighs 12 kg. Elizabeth weighs 72 kg and her school bag, with school books, weighs 8 kg.

1. Determine 15% of Elias's weight. Is his bag too heavy for him? (1)
 2. Determine 15% of Elizabeth's weight. Is her bag too heavy for her? (1)
- [2]

Solution

1. 9,9 kg. The bag is too heavy for him because it weighs more than 9,9 kg. ✓ (1)
 2. 10,8 kg. The bag is not too heavy for her because it weighs less than 15% of her body weight. ✓ (1)
- [2]



Worked example 5

Khuthale School has two soccer fields. The grass needs to be covered with fertiliser. A 30 kg bag of fertiliser costs R42,60. The school needs to buy 96 bags.

- a) How much will they pay for the fertiliser?
- b) How many kg of fertilizer will they buy in total?

Solutions

- a) Number of bags \times price
 $= 96 \times R42,60$
 $= R4\ 089,60$
- b) Number of bags \times weight of one bag
 $= 96 \times 30\text{ kg}$
 $= 2\ 880\text{ kg}$



Worked example 6

Mr Booyens needs to buy sand to build a new room onto his house. Sand is sold for R23 per kg. Mr Booyens needs to buy 0,8 tonnes of sand in order to build the room.

- Write the amount of sand needed in kg.
- Calculate the total amount of money he will have to spend to buy enough sand for the project.
- If sand is only sold in 50 kg bags, how many bags will Mr Booyens need to buy?

Solution

- Remember that 1 tonne = 1 000 kg
so he needs $0,8 \text{ tonnes} \times 1\,000 \text{ kg} = 800 \text{ kg}$
- Quantity of sand needed \times Cost per kg
 $= 800 \times 23$
 $= \text{R}18\,400$
- He will need: $800 \text{ kg} \div 50 \text{ kg}$
 $= 16 \text{ bags of sand}$



Activity 4: Cost and weight

A chef is preparing a meal that needs 3,75 kg of rice and 1,5 kg of beef. The recipe will feed 8 people.

- Rice is sold in packets of 2 kg. How many packets will he need for the meal? (1)
 - If rice costs R 31,50 per 2 kg pack, calculate the total cost of the rice he will need. (1)
 - If beef costs R 41,75 per kg, calculate the total cost of the beef needed for the meal. (1)
 - Calculate the total cost of the rice and the beef. (1)
- [4]**

Solutions

- 2 ✓ (1)
 - R63,00 ✓ (1)
 - R62,63 ✓ (1)
 - R125,63 ✓ (1)
- [4]**

4.4 Measuring volume and capacity

Volume is a measurement of how much space an object takes up. Capacity is a measure of how much liquid a container can hold when it is full.

For example, if you have a 500 ml bottle of cola, with 200 ml of cola left inside it, the capacity of the bottle is 500 ml, while the volume of cola inside it is 200 ml.

Is it possible to estimate the quantities of a substance that we need?



Yes, we can use estimation for measuring quantities of substances. For example we can use heaped teaspoons or a fraction of a standard quantity, like a quarter teaspoon of salt, or half a brick of butter.



e.g. Worked example 7

An urn of boiling water in an office has a capacity of 20 litres.

- a) If it is filled to maximum capacity, calculate the number of 250 ml cups that can be shared from it.
- b) After everyone has had their morning tea, there are only 6 litres of water left in the urn.
 - (i) How much water is this in ml?
 - (ii) How many 250 ml cups of water are left in the urn now?
 - (iii) What percentage is the remaining 6 litres of the urn's capacity?

Solutions

- a) $20 \text{ litres} = 20\,000 \text{ ml}$
Then $20\,000 \text{ ml} \div 250 \text{ ml} = 80$
80 cups can be poured from the urn.
- b) (i) $6 \text{ l} = 6\,000 \text{ ml}$
(ii) $6\,000 \text{ ml} \div 250 \text{ ml} = 24$
There are 24 cups of water left in the urn.
(iii) $6 \text{ l} \div 20 \text{ l} \times 100 = 30\%$
The urn is 30% full.

e.g. Worked example 8

Jabu is building a new flower bed and is using a bucket to carry soil from another part of the garden to the new bed. He knows his bucket has a capacity of 10 l.

- a) If 300 l of soil must be moved, and for each trip Jabu fills the bucket to the top with soil, how many trips will Jabu have to make with the bucket to move all the soil?
- b) Jabu decides that 10 litres of soil is too heavy to carry. How many trips will he have to make to move all the soil if he only fills the bucket with 7 litres of soil at a time?
- c) Jabu's friend Matthew arrives with his wheelbarrow and a spade. He suggests that Jabu should rather move the soil using the wheelbarrow. If the wheelbarrow has a capacity of 150 litres and they fill it to capacity, how many trips will Jabu have to make to move all the soil?

Solution

- a) $300 \ell \div 10 \ell = 30$ trips
 b) $300 \ell \div 7 \ell = 42,8$
 Jabu can't make 0,8 of a trip so we round this up to 43 trips (even though the bucket won't have 7 litres of soil in it for the last trip).
 c) $300 \ell \div 150 \ell = 2$ trips

**Activity 5: Measuring volume**

Jonathan uses the following recipe to make chocolate muffins:

$\frac{2}{3}$ cup of baking cocoa

2 large eggs

2 cups of flour

$\frac{1}{2}$ cup of sugar

2 teaspoons of baking soda

$1 \frac{1}{3}$ cups of milk

$\frac{1}{3}$ cup of sunflower oil

1 teaspoon of vanilla essence

$\frac{1}{2}$ teaspoon of salt

1. If 1 teaspoon = 5 ml, calculate how much baking soda Jonathan will use. Give your answer in ml. (1)
 2. Calculate the amount of vanilla essence Jonathan will use in this recipe. Give your answer in ml. (1)
 3. Jonathan does not own measuring cups but he does own a measuring jug calibrated in ml. How many ml of flour does he need? (1 cup = 250 ml) (1)
 4. If Jonathan buys a 100 ml bottle of vanilla essence, how many times will he be able to use the same bottle, if he bakes the same amount of muffins each time? (1)
 5. The recipe above is used to make 30 muffins. Calculate how many cups of flour Jonathan will need to make 45 muffins. (1)
- [5]

Solutions

1. 10 ml ✓ (1)
 2. 5 ml ✓ (1)
 3. 500 ml ✓ (1)
 4. 20 times ✓ (1)
 5. He will need 3 cups of flour. ✓ (1)
- [5]

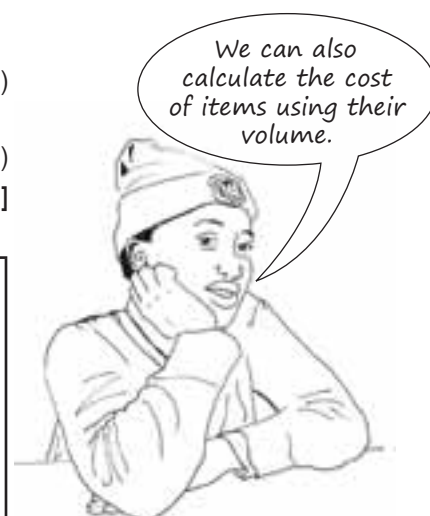

e.g. Worked example 9

Suppose paraffin is sold at R7,80 per litre at the service station.

- How much will you pay for 5 litres of paraffin?
- How many litres of paraffin will you be able to buy for R20? Round off your answer to two decimal places.
- If you have a paraffin lamp at home that can hold 500 mL of paraffin, how many times will you be able to refill the lamp if you buy 3 litres of paraffin?

Solutions

- Number of litres \times Cost per litre
 $= 5 \text{ litres} \times R7,80$
 $= R39$
- Amount of money \div Cost per litre
 $= R20 \div R7,80$
 $= 2,564 \ 102 \ 56\dots$
 $\approx 2,56 \text{ litres (to two decimal places)}$
- 3 litres = 3 000 mL
 $3 \ 000 \text{ mL} \div 500 \text{ mL}$
 $= 6$. You would be able to refill the lamp 6 times.

e.g. Worked example 10

Petrol costs R11,72 a litre.

- Calculate how much it costs to fill up a car that has a tank with a capacity of 50 litres.
- Calculate how many litres you could buy with R200. Round off your answer to two decimal places.

Solutions

- Number of litres \times Cost per litre
 $= 50 \text{ litres} \times R11,72$
 $= R586$
- Amount of money \div Cost per litre
 $= R200 \div R11,72$
 $= 17,064 \ 846 \ 4\dots$
 $\approx 17,06 \text{ litres (to two decimal places)}$



Activity 6: Cost and volume

1. Thandi is baking cupcakes and her recipe requires $1\frac{1}{3}$ cup of milk.
- 1.1** Calculate how many ml of milk she will need if 1 cup = 250 ml. (1)
- 1.2** If the recipe is for 20 cupcakes, calculate the amount of milk required to bake 30 cupcakes. Give your answer in litres. (2)
- 1.3** Milk is sold in bottles of 1 litre for R8,50 at the local store. Calculate the amount of money Thandi will need to spend on milk to make the 30 cupcakes. (1)
- [4]**

Solutions

- 1.1** 333 ml of milk. ✓ (1)
- 1.2** She will need 500 ml of milk, ✓ which is 0,5l. ✓ (2)
- 1.3** R8,50 (although she will only use half). ✓ (1)
- [4]**

2. Thabiso decides to sell homemade lemonade. He has made 5 litres of lemonade to sell at the local schools' rugby tournament.
- 2.1** Thabiso will be selling his lemonade in 250 ml plastic cups. Calculate the number of cups of lemonade he will be able to sell. (1)
- 2.2** If he sells the lemonade at R5 per cup, how much money will he make from the lemonade? (Assume that he sold all of his lemonade). (1)
- 2.3** If it cost Thabiso R120 to make the lemonade, how many cups would he need to sell (at R5 each) before he's made back the money he spent? (1)
- [3]**

Solutions

- 2.1** 20 cups ✓ (1)
- 2.2** R100 ✓ (1)
- 2.3** He would need to sell 24 cups just to cover his costs. ✓ (1)
- [3]**

4.5 Perimeter, area and volume

4.5.1 Estimation and direct measurement of perimeter

Perimeter is the total length of the outside of a shape or the continuous line forming the boundary of a closed geometric figure. Perimeter is calculated by adding together the lengths of each side of a shape. Perimeter is measured in mm, cm, m or km.

When we need to know how much of a material we require to do a certain task and how much it's going to cost, knowing how to calculate the perimeter and area of an object is important.



Some examples of how we can use this is when we need to calculate the area of a wall, to ensure we buy the correct quantity of paint, or when we need to calculate the perimeter of a vegetable garden, to know how much fencing we need to order.



Perimeter formula	
Rectangle $2 \times \text{length} + 2 \times \text{width}$	
Square $4 \times \text{length or } 4 \times \text{side}$	
Triangle $\text{length } 1 + \text{length } 2 + \text{length } 3$	
Circumference $\pi \times (2 \times \text{radius})$ or $\pi \times \text{diameter}$	



To measure the perimeter of a rectangle, a square or a triangle, we simply measure the length of each side using a ruler and add up the sides to get the perimeter.



To measure the perimeter of a circle, we need to use a piece of string: we can place the string along the outline of the circle, marking off how much string it took to go around the circle once. Then we measure that length of string on a ruler to estimate the perimeter of the circle.

The perimeter of a circle is the same as the **circumference** of the circle.



Worked example 11

Mr and Mrs Dlamini have recently moved into a new house. In the rectangular back yard, the house has a lawn and a rectangular patio as shown in the diagram.

- Using a ruler, measure the perimeter (in cm) of Mr and Mrs Dlamini's backyard on the diagram.
- If the diagram was drawn using a scale of 1 : 100, calculate the perimeter of the yard in metres.

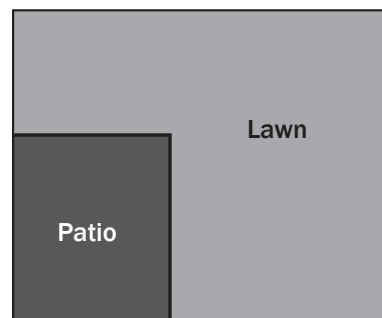

Solutions

- The length of the yard is 5 cm and the width is 4,2 cm.
Because the back yard is a rectangle, both pairs of opposite sides are equal in length.
The perimeter is the total length of the outside of the yard, therefore:
Perimeter = 4,2 cm + 4,2 cm + 5 cm + 5 cm
= 18,4 cm
- Using the scale of 1 : 100
Perimeter = 18,4 cm × 100
= 1 840 cm
= 18,4 m



Worked example 12

Mrs Dlamini wants to dig up some of the lawn and plant a triangular vegetable garden as shown in the diagram alongside.

- Using a ruler, measure the perimeter of the triangular garden in the diagram (in cm).
- If this diagram was drawn using a scale of 1 : 100, calculate the actual perimeter of the garden in metres.

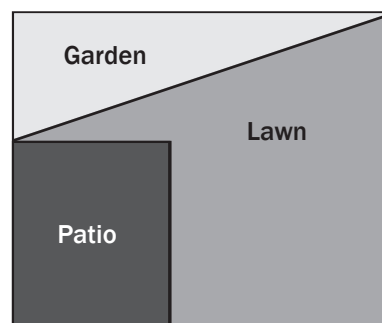

Solutions

- The perimeter of the triangle is = 1,7 cm + 5 cm + 5,3 cm
= 12 cm
- Using a scale of 1 : 100
= 12 cm × 100
= 1 200 cm
= 12 m



Activity 7: Measuring perimeter

Study the diagram alongside and answer the questions that follow.

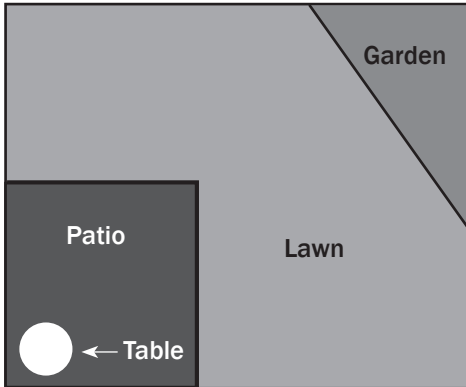

1. Before Mr Dlamini builds his fish pond, he decides he wants to make the patio smaller. Using a ruler, measure the new perimeter of the patio on the diagram (in cm). (1)
2. Mrs Dlamini decides it might be better to build her vegetable garden on the right of the garden because that area gets more sun. Using a ruler, measure the perimeter of the new triangular garden on the diagram (in mm). (1)
3. Mrs Dlamini also buys a new, circular table for the patio. Using a piece of string and a ruler, estimate the circumference of the table (in cm). (1)

[3]



You will always be given the perimeter formulae in your assessments.

Solutions

1. approximately 10 cm ✓ (1)
2. approximately 82 mm ✓ (1)
3. approximately 2,5 cm. ✓ (1)

[3]

Using formulae to calculate perimeter



e.g. Worked example 13

Using the formulae given earlier, study the diagram alongside and answer the questions that follow.

- Calculate the perimeter of the back yard, including the patio (i.e. the whole diagram) (in cm).
- Calculate the perimeter of the patio (in mm).
- Calculate the perimeter of Mrs Dlamini's garden (in cm).
- Calculate the perimeter of the table on the patio (in cm). Round your answer to 1 decimal place.
- Is your answer to number d) different to the table circumference you estimated in the previous activity, using string and a ruler? If it is, discuss why this could be with a friend.

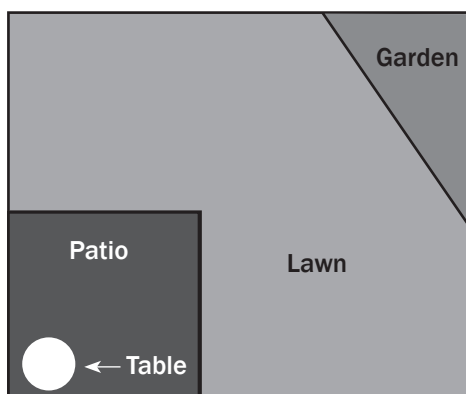

Solutions

- Perimeter of rectangular back yard = $2 \times \text{length} + 2 \times \text{width}$
 $= (2 \times 6,2 \text{ cm}) + (2 \times 5,2 \text{ cm})$
 $= 12,4 \text{ cm} + 10,4 \text{ cm}$
 $= 22,8 \text{ cm}$
- Perimeter of square patio = $4 \times \text{length}$
 $= 4 \times 2,5 \text{ cm}$
 $= 10 \text{ cm}$
 $10 \text{ cm} \times 10 = 100 \text{ mm}$
- Perimeter of triangular garden = $\text{length 1} + \text{length 2} + \text{length 3}$
 $= 2 \text{ cm} + 2,9 \text{ cm} + 3,5 \text{ cm}$
 $= 8,4 \text{ cm}$
- Circumference of table = $\pi \times \text{diameter}$
 $= \pi \times 0,8 \text{ cm}$
 $= 3,142 \times 0,8 \text{ cm}$
 $= 2,5136 \text{ cm}$
 $\approx 2,5 \text{ cm}$
- Previously, we estimated the circumference of the table using a piece of string and a ruler. Using the formula to calculate the circumference of a circle is more accurate than using a piece of string.

The shapes we have worked with so far have been simple. Sometimes we have to calculate the perimeter of a more complicated shape, which is made up of regular shapes that have been joined together, or in which the units are not all the same. We will look at how to do this in the next activity.





Activity 8: Combining shapes

Mrs Dlamini buys a new lampshade for a lamp. She measures the radius of the inside circle in the lampshade to be 50 mm. The diameter of the outside (larger) circle is 40 cm. (Note, the diagram is not drawn to scale.)

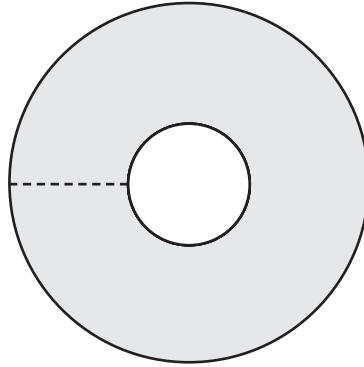

1. Calculate the circumference of the smaller, inner circle (in cm). (3)
 2. Calculate the circumference of the larger, outer circle (in cm).
Round off your answer to one decimal place. (3)
 3. Calculate the perimeter of half of the larger, outer circle (in cm). (1)
 4. Calculate the width of the area shown by the dotted line in the diagram above. (1)
- [8]**

Solutions

1. Inside circle perimeter/circumference = $2\pi r$ ✓ = $2 \times 3,142 \times 5 \text{ cm}$ ✓
= 31,42 cm ✓ (3)
 2. Circumference/perimeter = $2\pi r$ ✓ = $2 \times 3,142 \times 20 \text{ cm}$ ✓ = 125,7 cm ✓ (3)
 3. Half perimeter = $\frac{\text{Perimeter}}{2} = \frac{125,7}{2} = 62,85 \text{ cm}$ ✓ (1)
 4. Inner circle radius = 5 cm. Entire radius = 20 cm.
Difference between radii = $20 \text{ cm} - 5 \text{ cm} = 15 \text{ cm}$ ✓ (1)
- [8]**

4.5.2 Using formulae to calculate area



You will always be given these formulae in your assessments.

Area formula	Diagram
Rectangle $\text{length} \times \text{width}$	
Square $\text{length} \times \text{length} = \text{length}^2$ or $\text{side} \times \text{side} = \text{side}^2$	
Triangle $\frac{1}{2} \times \text{base} \times \text{perpendicular height}$	
Circle $\pi \times \text{radius}^2$	

A perpendicular line is a straight line that lies at an angle of 90° to a given line, plane, or surface.



e.g. Worked example 14

Using the appropriate formula from the given table, calculate the areas of the following three shapes (in cm^2). Diagrams are not drawn to scale.

a)

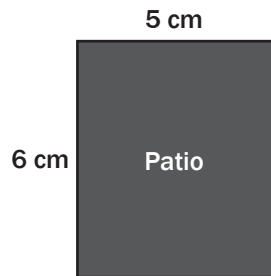

b)

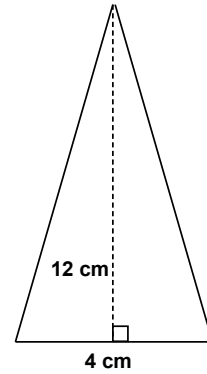

c)

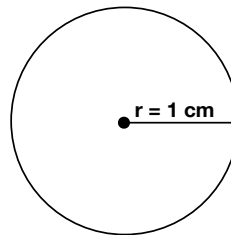

When using formulae to calculate area we will not always be working with regular, simple shapes. Sometimes we will be asked to calculate the area of more complex shapes.



Solutions

$$\begin{aligned} \text{a) Area of rectangle} &= \text{length} \times \text{width} \\ &= 5 \text{ cm} \times 6 \text{ cm} \\ &= 30 \text{ cm}^2 \end{aligned}$$

$$\begin{aligned} \text{b) Area of triangle} &= \frac{1}{2} \times \text{base} \times \text{perpendicular height} \\ &= \frac{1}{2} \times 4 \text{ cm} \times 12 \text{ cm} \\ &= 24 \text{ cm}^2 \end{aligned}$$

$$\begin{aligned} \text{c) Area of circle} &= \pi \times \text{radius}^2 \\ &= 3,142 \times (1 \text{ cm})^2 \\ &= 3,142 \times 1 \text{ cm}^2 \\ &= 3,142 \text{ cm}^2 \end{aligned}$$

In this case, it is easy to solve the problem by breaking down the complex object into smaller shapes, finding the area of each smaller shape, and then adding the individual areas together. The next worked example will show you how to work with such shapes.



e.g. Worked example 15

Your Mathematical Literacy classroom gets new tables, shaped as shown alongside.

- a) Using the appropriate formulae, calculate the area of the table, in m^2 .
- b) If each table cost R615 and ten tables were bought, calculate how much the tables cost per m^2 .
(Hint: calculate the total cost of the tables and their total area first.)

Solution

- a) We can see that the table is made up of two identical triangles, and one rectangle.

The formula for the area of a triangle is:

$$\frac{1}{2} \times \text{base} \times \text{height}.$$

So the area of one of our triangles is:

$$\begin{aligned} & \frac{1}{2} \times 500 \text{ mm} \times 70 \text{ cm} \\ &= \frac{1}{2} \times 0,5 \text{ m} \times 0,7 \text{ m (change the units to metres)} \\ &= 0,175 \text{ m}^2 \end{aligned}$$

The formula for the area of a rectangle is: length \times breadth.

So the area of the middle rectangle is:

$$\begin{aligned} & 0,9 \text{ m} \times 70 \text{ cm} \\ &= 0,9 \text{ m} \times 0,7 \text{ m (change the units to metres)} \\ &= 0,63 \text{ m}^2 \end{aligned}$$

Now we simply add the three areas together:

$$\begin{aligned} & \text{Area triangle} + \text{area rectangle} + \text{area triangle} \\ &= 0,175 \text{ m}^2 + 0,63 \text{ m}^2 + 0,175 \text{ m}^2 \\ &= 0,98 \text{ m}^2 \end{aligned}$$

- b) 10 tables will cost $\text{R}615 \times 10 = \text{R}6\,150$.
10 tables will have a total area of $0,98 \text{ m}^2 \times 10 = 9,80 \text{ m}^2$.
 $\text{R}6\,150 \div 9,80 \text{ m}^2 = \text{R}627,55$
So the tables cost R627,55 per square metre.

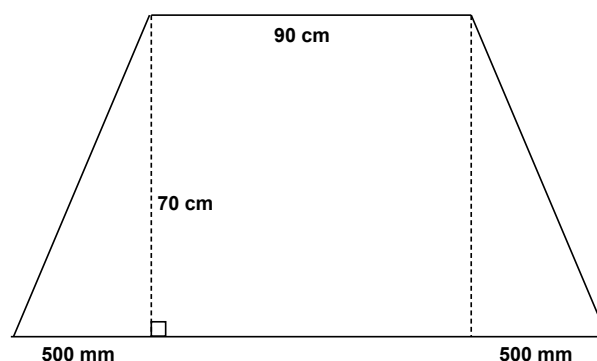

Activity 9: Combining areas

For your birthday, a friend gives you a rare, lucky coin that has a square cut out of the middle as shown in the photo and diagram.

- You measure the diameter of the circle to be 3 cm, and the length of one side of the square to be 0,9 cm. Calculate the area of the coin in cm^2 .
Round off your answer to one decimal place. (7)
- If the coin is worth R3,58 per cm^2 , calculate its value. (2)

[9]

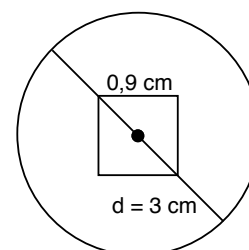

Solutions

1. To calculate the area of the coin, we need to calculate the area of the circle, and then subtract from this the area of the square cut-out.

The formula for the area of a circle is $\pi \times \text{radius}^2$. ✓

We know the diameter is 3 cm, therefore the radius is 1,5 cm.

Therefore the area of the circle is:

$$\begin{aligned} &\pi \times (1,5 \text{ cm})^2 \\ &= 3,142 \times 2,25 \text{ cm}^2 \checkmark \\ &= 7,0695 \text{ cm}^2. \checkmark \end{aligned}$$

(Remember, we shouldn't round off while we are still busy with our calculations! We should only round off our final answer.)

The formula for the area of a square is $\text{side} \times \text{side} = (\text{side})^2$. ✓

Therefore the area of the square is:

$$(0,9 \text{ cm})^2 = 0,81 \text{ cm}^2. \checkmark$$

We now subtract the area of the cut-out square from the area of the circle:

$$7,0695 \text{ cm}^2 - 0,81 \text{ cm}^2 = 6,2595 \text{ cm}^2 \checkmark$$

so the area of the coin is $6,2595 \text{ cm}^2 \approx 6,3 \text{ cm}^2$. ✓

(7)

2. $6,2595 \text{ cm}^2 \times R3,58 \checkmark = R22,409 \text{ 01} \approx R22,41 \checkmark$



(2)

[9]

Volume is used to measure the amount of space inside a 3-dimensional object or container.



4.5.3 Using formulae to calculate volume

Shape	Volume formula	
Rectangular box	$V = l \times b \times h$	
Cylinder	$V = \pi \times r^2 \times h$	



Cubic units are used to measure volume, for example: mm^3 , cm^3 , m^3 or km^3 . We will work with the volume of rectangular boxes and cylinders.



Worked example 16

Cedric is building a house. First he digs the rectangular foundation for the house. The foundation is filled with cement. The dimensions of the foundation are $8 \text{ m} \times 0,5 \text{ m} \times 0,5 \text{ m}$.

- Calculate the volume of the foundation.
- If concrete for the foundation costs R180,00/m³, what is the total cost of the concrete for the foundation?
- Cedric finds cheaper concrete at a total cost of R320 for 2 m³. Calculate the cost per m³.

Solutions

- Volume = $8 \times 0,5 \times 0,5$
= 2 m³
- Total cost of concrete = $2 \times \text{R}180,00$
= R360,00
- Cost per m³ = $\text{R}320,00 \div 2$
= R160,00



Activity 10: Calculating volume

Allison needs to bake cookies for her son's crèche. She finds a recipe for cookies. She needs to calculate the volume of 1 cookie so that she knows what size container she can use. Each cookie is shaped like a flat cylinder. She measures a cookie and finds that it has these dimensions: diameter = 80 mm; height = 7 mm.

- Calculate the volume of 1 biscuit, to one whole number. (3)
 - Calculate the volume of 50 biscuits. (1)
 - Would a container with a volume of 700 cm³ hold the biscuits? Explain. (2)
- [6]

Solutions

- 35 190 mm³ ✓
 $\pi r^2 h$ ✓
 = $\pi(40)^2(7)$ ✓ (3)
 = $\pi(1600)(7)$
 - 1 759 500 mm³ ✓ (1)
 - 1 759,5 cm³ (No 700 cm³ < 1 759,5 cm³) ✓✓ (2)
- [6]



Activity 11: Multi-step volume problem

A school builds a swimming pool with the following dimensions:

length = 15 m; depth = 1,3 m to the filling level, and width = 5 m.

($1 \text{ m}^3 = 1\,000 \text{ l}$ and $1\,000 \text{ l} = 1 \text{ k}\ell$)

1. Calculate the volume of the swimming pool up to the level it is filled. (1)
 2. Convert this volume (i) to litres (ii) and kilolitres. (2)
 3. When the school fills the pool, they use a pump which pumps water at a rate of 2 l per second. How long would it take to fill up the pool? Give your answer in hours and minutes. (1)
 4. Water costs R8,64 per kilolitre. How much will it cost the school to fill up the pool? (1)
- [5]**

Solutions

1. $97,5 \text{ m}^3$ ✓ (1)
 2. (i) 97 500 l (ii) 97,5 kℓ ✓✓ (2)
 3. So the total time taken is 13 hr 32½ min ✓ (1)
 4. R842,40 ✓ (1)
- [5]**

4.6 Calculating elapsed time

Elapsed time, or duration, is the measurement of time passing. When doing calculations like this, we add the units of time separately. Be careful when working with remainders!



Worked example 17

- a) School starts at 07:45. You are in class for 2 hours 30 minutes. What time will the bell ring for first break? Give your answer in the 24-hour format.
- b) Palesa starts cooking dinner at 6:00 p.m. She has to leave for her choir practice in 1 hour and 45 minutes.
- (i) What time must she leave? (Give your answer in the 12-hour format.)
- (ii) Convert your answer to the 24-hour format.
- c) The bus leaves school at 14:30. It takes 70 minutes to get to Mulalo's house.
- (i) What time will he arrive at home? (Give your answer in the 24-hour format.)
- (ii) Convert your answer to the 12-hour format.

Solutions

- a) First add the hours: $07:00 + 2 \text{ hours} = 9:00$
Then add the minutes:
 $45 \text{ minutes} + 30 \text{ minutes} = 75 \text{ minutes}$
 $75 \text{ minutes} = 60 \text{ minutes and } 15 \text{ minutes} = 1 \text{ hour and } 15 \text{ minutes}$
Calculate the total time elapsed:
 $9:00 + 1 \text{ hour } 15 \text{ minutes} = 10:15$
So the bell will ring for break at 10:15.
- b) (i) First add the hours: $6:00 \text{ p.m.} + 1 \text{ hour} = 7:00 \text{ p.m.}$
Then add the minutes: $0 \text{ minutes} + 45 \text{ minutes} = 45 \text{ minutes}$
Calculate the total time that will elapse: $7:00 \text{ p.m. and } 45 \text{ minutes} = 7:45 \text{ p.m.}$
So Palesa must leave at 7:45 p.m.
- (ii) To convert this to the 24-hour time format we simply add 12 hours to the time:
 $7:45 \text{ p.m.} + 12 \text{ hours} = 19:45.$
- c) (i) First we break down 70 minutes into hours and minutes.
We know that $60 \text{ minutes} = 1 \text{ hour}$. $70 \text{ minutes} - 60 \text{ minutes} = 10 \text{ minutes}$, so the bus ride takes 1 hour and 10 minutes.
Now we add the hours:
 $14:00 + 1 \text{ hour} = 15:00.$
Next we add the minutes: $30 + 10 = 40 \text{ minutes}$.
So Mulalo will arrive home at 15:40.
- (ii) To convert our answer to the 12-hour format we **subtract** 12 hours:
 $15:40 - 12 \text{ hours} = 3:40.$ We know that 15:40 is after midday, so Mulalo will arrive home at 3:40 p.m.



Activity 12: Calculating elapsed time

1. Unathi's father goes to work at 8:00 a.m. He fetches her from school 7 hours and 30 minutes later. What time will he fetch her? Give your answer in the 24-hour format. (1)
2. Lauren finishes her music class at 15:30. It takes her 30 minutes to get home. She then does homework for 50 minutes. Lauren meets her friend 20 minutes after she finishes her homework. What time do they meet? Give your answer in the 12-hour format. (1)
3. Heather starts baking biscuits at 6:15 p.m. The biscuits must come out of the oven at 6:35 p.m. and need to cool for another 20 minutes before they can be eaten.
 - a) How long will the biscuits be in the oven? (1)
 - b) What time will they be ready to eat? (Give your answer in the 12-hour format.) (1)
4. Alison's favourite TV show starts at 20:35. It is forty-five minutes long.
 - a) What time will it finish? (1)
 - b) If Alison watches the movie that follows her favourite show and it finishes at 10:50 p.m., how long was the movie (in hours and minutes)? (1)
5. Vinayak is meeting his brother for lunch at 13:15. He also wants to go to the shops before lunch. It will take him 20 minutes to get from the shops to the restaurant where he's meeting his brother. If he leaves home at 10:10 how much time does he have to do his shopping? Give your answer in hours and minutes. (1)

[7]

Solutions

1. 15:30 ✓ (1)
2. 5:10 p.m. ✓ (1)
3. a) 20 minutes ✓ (1)
- b) 6:55 p.m. ✓ (1)
4. a) 21:20 ✓ (1)
- b) 1 hour, 30 minutes ✓ (1)
5. 2 hours, 45 minutes ✓ (1)

[7]

4.6.1 Calendars

Calendars are useful tools to help us keep track of events that are going to happen and to plan our lives accordingly. We can add information to them about important events and dates (like birthdays and school holidays). We can read off days, weeks and months on a calendar and do conversions between these units of time.

You may have come across a time conversion that states that 4 weeks is approximately equal to one month. This is not quite correct. 4 weeks is equal to 28 days, but the months (except February!) have 30 or 31 days in them. When working with calendars, be careful to count the right number of days in a particular month!



Worked example 18

Jess's calendar for the month of May is given below. Study it carefully and answer the questions that follow.

						
MAY 2013						
MON	TUES	WED	THURS	FRI	SAT	SUN
		1 Workers' Day	2 Dad's birthday	3	4	5
6	7 Netball match	8	9	10	11	12 Mother's Day
13	14	15	16	17 School camp	18 School camp	19 School camp
20	21	22 Maths Lit test	23	24	25 Granny comes to visit	26
27	28	29	30	31		

- a) If it is Monday 6 May, calculate how many days it is until:
- Mother's Day
 - Jess goes on her school camp
 - Jess's granny comes to visit.
- b) If it is 8 May:
- How many weeks does Jess have to study for her Mathematical Literacy test?
 - How many days does she have to study for the test?
 - How many days ago was her dad's birthday?
- c) Will Jess go to school on 1 May? Give a reason for your answer.
- d) Jess needs to buy a present for her mother for Mother's Day. If she has plans with friends on 11 May, by when should she have bought the present?
- e) Jess is invited to a party on Saturday 18 May. Will she be able to attend?
- f) Jess wants to bake a cake for her granny but has plans with a friend for the morning of 25 May.
- If her granny arrives in the evening of 25 May, when should Jess bake the cake?
 - Given that she's busy on the morning of 25 May, when should Jess make time to buy the ingredients for the cake?

Solutions

- a) (i) 6 days (ii) 11 days (iii) 19 days
- b) (i) 2 weeks (ii) 14 days (iii) 6 days ago
- c) No. 1 May is Workers' Day which is a public holiday.
- d) Jess should buy a present for her mother by Friday 10 May.
- e) No. She will be away on her school camp.
- f) (i) On the afternoon of Saturday 25 May.
- (ii) On or before Friday 24 May.

4.6.2 Timetables

Timetables are similar to calendars in that they help us plan our time. Where calendars are useful for planning months and years, timetables are useful for planning shorter periods of time like hours, days and weeks. You may already be familiar with timetables like those for your different classes at school, and for TV shows. In this section we will learn how to read timetables and how to draw up our own.



Worked example 19

Look at the timetable below and answer the following questions.

	SABC 1	SABC 2	SABC 3	e-TV
5:30 p.m.	Siswati/Ndebele News	News	Days of Our Lives	It's My Biz
6:00 p.m.	The Bold and the Beautiful	Leihlo La Sechaba		eNews Early Edition
6:30 p.m.	Zone'd TV	7de Laan	On The Couch	Rhythm City
7:00 p.m.	Jika Majika	Nuus	News	eNews Prime Time
7:30 p.m.	Xhosa News	American Idol	Isidingo	Scandal!
8:00 p.m.	Generations		Mad About You	
8:30 p.m.	Shakespeare: uGugu No Andile	News	Welcome to The Parker	Panic Mechanic
9:00 p.m.		Muvhango		

- What is the difference in time between the English News at 5:30 p.m. and the English News at 8:30 p.m. (both on SABC 2)?
- How long, in minutes, is American Idol?
- If Zonke wants to watch Isidingo after dinner at 7:30 p.m., and she needs 90 minutes to cook and eat dinner, what time should she start cooking dinner?
- Mandla wants to watch It's My Biz and Generations. He plans to do his homework in between the two shows. If he expects each subject's homework to take 30 minutes, how many subjects worth of homework will he be able to complete between the two shows?
- Sipho wants to watch the news in English and in Afrikaans, at the same time. Would this be possible? Give a reason for your answer.
- Why are the blocks on the timetable for SABC 3, blank for 8:30 p.m. and 9:00 p.m.?
- What is the total time period allocated to the News (in all languages) across all four TV channels?

Solutions

- 3 hours
- $7:30$ to $8:30$ p.m. = 1 hour = 60 minutes
- 90 minutes = 1 hour + 30 minutes
 $7:30$ p.m. - 1 hour = $6:30$ p.m.
 $6:30$ p.m. - 30 minutes = $6:00$ p.m.
- It's My Biz finishes at $6:00$ p.m. and Generations starts at $8:00$ p.m. This gives Mandla 2 hours to do his homework.
 2 hours = 120 minutes
 $120 \text{ minutes} \div 30 \text{ minutes} = 4$
 So Mandla will be able to do homework for four subjects in between the two shows.

- e) Yes, there is the English News on SABC 3 at 7:00 p.m. and on SABC 2 there is the Afrikaans Nuus at that same time. However, he cannot watch two channels at the same time. He would need to choose a channel to watch.
- f) They are blank because the program “Welcome to the Parker” is still showing.
- g) There are 8 sets of news slots appearing on the timetable. Each slot is 30 minutes. Therefore, a total of 4 hours of news will be shown between 5:30 p.m. and 9:00 p.m. on four channels.



Activity 13: Drawing up a timetable

Sipho and Mpho are brothers. Their parents require them to do household chores every day. These chores need to fit into their school sports and homework timetables.

Using the information provided in the table below, construct a timetable for each brother for one day of the week.

The two brothers' timetables need to be clearly laid out and easy to read.

SIPHO	MPHO
Soccer practice 15:30 - 16:30	Music lesson (1 hour)
Feed the dogs	Walk the dogs for a minimum of 30 minutes
Wash the dishes	Study for Maths test - 45 minutes
Complete his Life Orientation task - 45 minutes	Set (and clear) the table before and after dinner
Watch the news at 19:00 for his history assignment	Look through the newspaper for any information on natural disasters for his geography homework.

Solution

For example:

Sipho:

Time	Event
15:30 - 16:30	Soccer practice
18:00	Feed dogs and wash dishes
19:00	Watch news for history assignment
19:30 - 20:15	Complete LO task

CAPE TOWN TO LANGA - LAVISTO

CAPE TOWN TO LANGA - LAVISTOWN - KAPTEENSKLIP - KHAYELITSHA - CHRIS HANI

		MONDAY TO FRIDAY														MONDAY TO																		
CAPE TOWN PLATFORM NO		16	17	19	20	16	17	20	16	15	20	18	19	18	15	21	18	15	20	15	21	17	15	20										
TRAIN NO		9601	5911	9003	9913	9025	9503	9915	9007	9625	9507	9917	9011	9529	9513	9523	9017	9615	9925	9617	9019	9677	9619	9621	9929									
CAPE TOWN		05:09	05:05	05:10	05:35		05:40	05:02	06:12	06:10	06:30	06:40	06:45	06:52	07:07	07:10	07:10	07:22	07:30	07:43	07:52	08:00	08:10	08:15	08:30	08:35	08:45	09:00	09:05	09:30	09:35			
WOODSTOCK		05:03					05:43			06:13	06:33			06:55				07:25			07:55			08:18	08:38				08:08	09:33				
SALT RIVER		05:06					05:46			06:16	06:36			06:58				07:28			07:58			08:21	08:41				09:11	09:36				
KOEBERG RD		05:09					05:48			06:18	06:38			07:00				07:30			08:00			08:23	08:43				09:13	09:38				
MAITLAND		05:11					05:51			06:21	06:41			07:03				07:33			08:03			08:26	08:46				09:16	09:41				
NDABENI		05:14					05:54			06:24	06:44			07:06				07:36			08:06			08:29	08:49				09:19	09:44				
PIVELANDS		05:16					05:56			06:26	06:46			07:08				07:38			08:08			08:31	08:51				09:21	09:46				
ESPLANADE			05:09	05:14	05:39			06:06	06:16			06:44	06:49		07:11	07:14			07:34	07:47			08:04	08:14	08:34		08:49	09:04			09:39			
PAARDENLAND																																		
YSTERPLAAT																																		
MUTUAL																																		
LANGA																																		
BONTEHEUWEL A																																		
D																																		
NETREG																																		
HEERVELD																																		
NYANGA																																		
PHILIPPI																																		
LENTEGUR A																																		
D																																		
MITCHELLS PL																																		
KAPTEENSKLIP																																		
STOCK ROAD																																		
MANDAJAY A																																		
D																																		
NOLUNGLE																																		



Activity 14: Reading a time table

Mr Odwa and his family live in the informal settlement in Langa Township. Mr Odwa has two school going kids Zonke and Andile who are attending the school at Philippi High. Mrs Odwa is a school teacher at Mandalay Secondary, while Mr Odwa works in a construction company in Woodstock.

Use the train table on the previous page to answer these questions.

1. If Zonke and Andile want to be at Philippi station at 07:31 what time must they catch a train in Langa station? (1)
2. Which platform will that train depart from? (1)
3. Give the train number and platform number for the train that will stop at Heideveld at 08:23. (2)
4. If Mrs Odwa Pamela is at Mandalay at 09:12 what time did she depart from Langa station? (1)
5. Mr Odwa works night shift and he wants to meet his two kids at Langa station before they catch their train to school. What time should he take the train in Woodstock and at which platform is that train going to stop? (2)
6. If the school starts at 08:00 and the kids miss the train mentioned in 1, what time will be the next train and what number and platform must they be on to catch the train? (3)
7. Is it possible for Mr Odwa to use the same time table to find the time for a train from Langa to Woodstock? Explain your answer. (2)

[12]

Solutions

1. 07:13 ✓ (1)
2. 16 ✓ (1)
3. Train number - 9513 ✓
Platform - 16 ✓ (2)
4. 8:48 ✓ (1)
5. 6:33 (Platform 16 and Train 9507) ✓✓ (2)
6. 7:25 on Platform 20 (Arrive in Philippi at 07:44) ✓✓✓ (3)
7. No. The time table is one way from Cape Town to Chris Hani. ✓✓ (2)

[12]



5 Unit

Maps, plans and other representations of the physical world

5.1 Scale

The two kinds of scale we will be working with in this chapter are the number scale and the bar scale.

5.1.1 The number scale

- is expressed as a ratio like 1 : 50.

This says that 1 unit on the map represents 50 units on the ground. For example, 1 cm on the map will represent 50 cm on the ground and 1 m on the map will represent 50 m on the ground.

It is very important to know your conversions!



To use the number scale, you need to measure a distance on a map using your ruler or use the distance provided, and then multiply that measurement by the “real” part of the scale ratio given on the map, in order to get the real distance.

e.g. Worked example 1

- You measure the distance between two buildings on a map to be 10 cm. If the map has a number scale of 1 : 40, what is the actual distance in metres on the ground?
- You are given a map with the number scale 1 : 50 000. You measure a distance of 15 cm on the map. What is the actual distance in km?

Solutions

- Scale is 1 : 40.
 $10 \text{ cm} \times 40 = 400 \text{ cm} = 4 \text{ m}$
The distance on the ground (in real life) is 4 m.
- Scale is 1 : 50000
Therefore actual distance is $15 \text{ cm} \times 50\,000 = 750\,000 \text{ cm} = 7,5 \text{ km}$.



Activity 1: Using the number scale

Study the school map given below and answer the questions that follow.

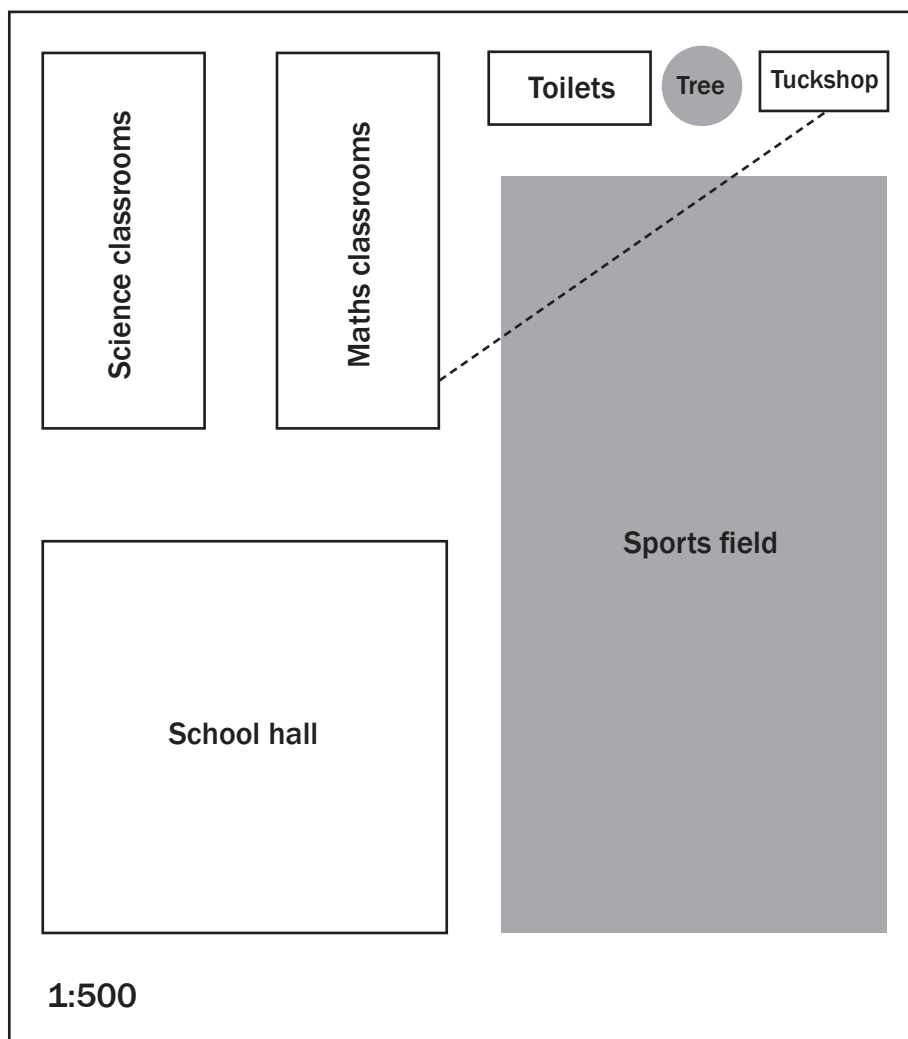

- Use the given scale to calculate the following real dimensions of the sports field in metres:
 - width (4)
 - length. (4)
- Use the given scale to calculate the length of the science classroom block in metres. (2)
- Zuki walks from the tuck-shop to his maths classroom, along the broken line shown. Measure how far he walked in metres. (2)

[12]

Solutions

- 1. a)** Use your ruler to measure the width of the sports field on the map.
It is 5 cm wide. ✓
Now use the number scale 1 : 500 to determine the actual width of the field:
 $5 \text{ cm} \times 500 = 2\,500 \text{ cm}$ ✓✓
(multiply your scaled measurement by the “real” number in the scale ratio)
 $2\,500 \text{ cm} \div 100 = 25 \text{ m}$
The field is 25 m wide. ✓ (4)
- b)** On the map, the field is 10 cm long. ✓
 $10 \times 500 = 5\,000 \text{ cm}$
 $5\,000 \text{ cm} \div 100 = 50 \text{ m}$ ✓✓
The field is 50 m long. ✓ (4)
- 2.** On the map, the science classroom building is 5 cm long.
 $5 \text{ cm} \times 500 = 2\,500 \text{ cm}$ ✓
 $2\,500 \text{ cm} \div 100 = 25 \text{ m}$ ✓
The science classrooms are 25 m long. (2)
- 3.** The broken line is 6,2 cm long on the map.
 $6,2 \times 500 = 3\,100 \text{ cm}$ ✓
 $3\,100 \text{ cm} \div 1\,000 = 31 \text{ m}$ ✓
Zuki walked 31 m from the tuck-shop to his maths classroom. (2)
- [12]**

5.1.2 The bar scale

- is represented like this:

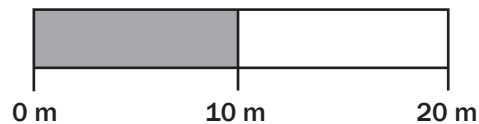

Each piece or segment of the bar represents a given distance, as labelled underneath. To use the bar scale:

- You need to measure how long one segment of the bar is on your ruler. You must then measure the distance on the map in centimetres.
- Calculate how many segments of the bar graph it works out to be (the total distance measured; divided by the length of one segment).
- Then multiply it by the scale underneath.

So, if 1 cm on the bar represents 10 m on ground, and the distance you measure on the map is 3 cm ($3 \text{ cm} \div 1 \text{ cm length of segment} = 3 \text{ segments}$) then the real distance on the ground is $3 \times 10 \text{ m} = 30 \text{ m}$.



Worked example 2

- a) You measure a distance of 10 cm on a map with the following bar scale:

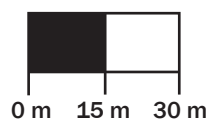

If the bar scale is 1 cm:15 m, what is the actual distance on the ground in metres?

- b) You measure a distance of 11 cm on a map with the following bar scale:

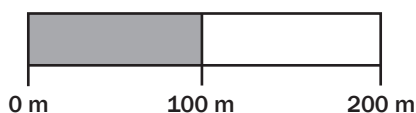

If the bar scale is 2 cm : 100 m, what is the actual distance on the ground in metres?

Solutions

- a) 1 segment on the bar scale = 1 cm on the ruler.

0,01 m on the ruler represents 15 m on the ground.

Therefore the scale is 0,01:15.

10 cm = 0,1 m on the ruler represents $15 \times 10 = 150$ m on the ground.

OR

1 segment on the bar scale = 1 cm on the ruler.

1 cm on the ruler represents 15 m = 1 500 cm on the ground.

Therefore the scale is 1:1 500.

10 cm on the ruler represents $1\,500 \times 10 = 15\,000$ cm = 150 m on the ground.

OR

2 segments on the bar scale = 2 cm on the ruler.

2 cm on the ruler represents 30 m on the ground.

10 cm on the ruler represents $30 \times 5 = 150$ m on the ground.

- b) 1 segment on the bar scale = 2 cm on the ruler.

2 cm on the ruler represents 100 m on the ground.

11 cm on the ruler represents $\frac{100 \times 11}{2} = 550$ m on the ground.

OR

2 segments on the bar scale = 4 cm on the ruler.

4 cm on the ruler represents 200 m on the ground.

11 cm on the ruler represents $\frac{200 \times 11}{4} = 550$ m on the ground.

Both values must be written in the same units!

Both values must be in the same units!
Remember your CONVERSIONS!

Remember to get rid of the unwanted unit

5.1.3 Understanding the advantages and disadvantages of number and bar scales

By now you should understand how to use number and bar scales to measure real dimensions and distances on the ground when given a scale map. What happens if you resize a map? For example, you may want to make small photocopies of a map of your school, to hand out for an event taking place. In the next activity you will explore the effects on the number and bar scales when we resize maps.



Activity 2: Scales and resizing



1 : 15

Diagram 1



1 : 15

Diagram 2



0cm 15cm 30cm

Diagram 3



0cm 15cm 30cm

Diagram 4

1. Measure the width of the school bag in Diagram 1 and use the scale to calculate the real width of the school bag. (1)
 2. Measure the school bag in Diagram 2 and use the scale to calculate the real width of the school bag. (1)
 3. What do you notice about the answers for 1 and 2? (1)
 4. Measure the width of the school bag in Diagram 3 and use the scale to calculate the real width of the school bag. (2)
 5. Measure the school bag in Diagram 4 and use the scale to calculate the real width of the school bag. (2)
 6. What do you notice about the answers for 4 and 5? (1)
- [8]

Solutions

1. $2,6 \times 15$
= 39 cm ✓ (1)
 2. 4×15
= 60 cm ✓ (1)
 3. Not the same ✓ (1)
 4. $1,7 : 30$ ✓
 $\frac{30}{1,7} \times 2,5 = 44$ cm ✓ (2)
 5. $2,9 : 30$ ✓
 $\frac{30}{2,9} \times 4,3 = 44$ cm ✓ (2)
 6. Same ✓ (1)
- [8]**

If we resize a map that has a number scale on it, the number scale becomes incorrect. If a map is 10 cm wide when printed, and the number scale is 1 : 10 then 1 cm on the map represents 10 cm on the ground. However, if we reprint the map larger, and it is now 15 cm wide, our scale will still be 1 : 10 according to the map, but now 1,5 cm represents 10 cm on the ground ($1,5 \times 10 = 15$ cm = width of map) so the answers to any scale calculations will now be wrong.

An advantage of a bar scale is when resizing a map that has a bar scale on it, the size of the bar scale will be resized with the map, and it will therefore remain accurate.

A disadvantage of using a number scale is when resizing maps that use the number scale, it is important to know that the scale changes with the map.

An advantage of the number scale is that we only have to measure one distance (we don't have to measure the length of one bar segment) and our calculations are usually fairly simple.

A disadvantage of using the bar scale is that we have to measure the length of one segment and measure the distance on the map. Our calculations can be more complicated because we have to calculate how many segments fit into the distance measured on the map.



5.1.4 Drawing a scaled map when given real (actual) dimensions

We have learnt how to determine actual measurements when given a map and a scale. In this section we will look at the reverse process - how to determine scaled measurements when given actual dimensions, and draw an accurate two dimensional map. Remember that a scale drawing is exactly the same shape as the real (actual) object, just drawn smaller. In the next worked example we will look at how to draw a simple scaled map of a room.

In order to draw a map you need two types of information. Firstly you need to know the actual measurements of everything that has to go onto the map. Secondly you need to know what scale you have to use. The scale will depend on the original measurements, how much detail the map has to show and the size of the map. If you want to draw a map, or plan, of a room in your house on a sheet of A4 paper and include detail of the furniture you would not use a scale of 1 : 10 000 (this scale means that 1 cm in real life is equal to 10 000 cm or 1 km in real life).

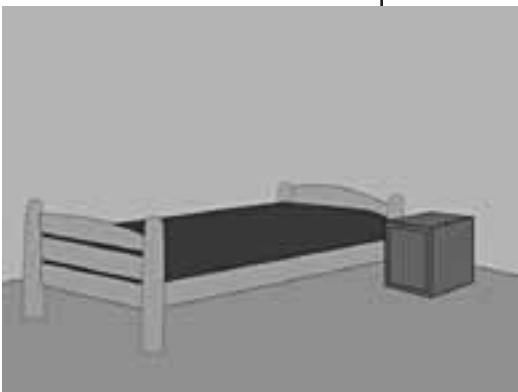

Worked example 3

The bedroom in the picture is 3,5 m by 4 m. It has a standard sized single bed of 92 cm by 188 cm. The bedside table is 400 mm square. Draw a floor plan to show the layout of the room. Use the number scale 1 : 50.

Solutions

The scale of 1 : 50 means that 1 unit on your drawing will represent 50 units in real life so 1 cm on your drawing will represent 50 cm in real life.

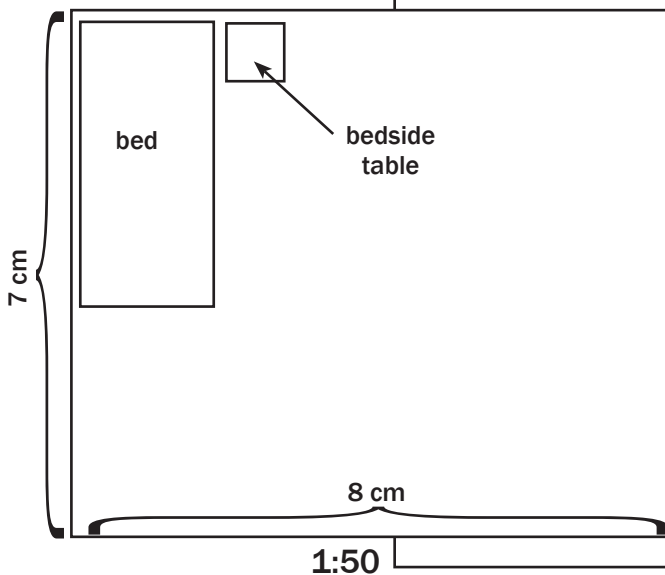

- The width of the room is 3,5 m.
Convert 3,5 m to cm:
 $3,5 \times 100 = 350 \text{ cm}$
Use the scale to calculate the scaled width on the map:
 $350 \text{ cm} \div 50 \text{ cm} = 7 \text{ cm}$
(Divide the actual, real measurement of the room by the 'real number' from the scale.)
- The length of the room is 4 m.
Convert 4 m to cm:
 $4 \times 100 = 400 \text{ cm}$
Use the scale to calculate the scaled length on the map:
 $400 \text{ cm} \div 50 \text{ cm} = 8 \text{ cm}$
- The scaled bed is 3,76 cm by 1,84 cm.
- The scaled table is 0,8 cm by 0,8 cm.



Activity 3: Drawing a scaled plan

Your school is building a new classroom. The measurements of the classroom are as follows:

length of each wall: 5 metres, width of the door: 810 mm, width of the windows: 1 000 mm

Use the appropriate symbols to draw a plan of the classroom using a scale of 1 : 50. (14)

Place a door, 2 windows in one of the walls and 3 windows in the opposite wall.

1. If the school wants to make blinds out of fabric for the classroom windows, and the blinds are the same size as the windows (1 000 mm wide), calculate the total length of material (in metres) that needs to be bought. (2)
2. If the material for the blinds costs R 60 per metre, calculate the total cost of fabric for the blinds. (1)
3. The school needs to tile the floor of the classroom. Calculate the total area that must be tiled. (2)
4. If the tiles come in 4 m² boxes, how many boxes must the school buy? Explain your answer. (2)
5. If the tiles cost R 150 per box, calculate how much the tiles will cost. (1)



Two walls have no windows in your plan.

[22]

You must now convert metres and millimetres to centimetres.

Solutions

Conversions

	Real life measurement	Calculation	Measurement on the plan
Length of the walls	5 metres	5 metres = 500 cm 500 cm ÷ 50 = 10 cm ✓	10 cm ✓
Width of the door	810 mm	810 mm ÷ 50 = 16,2 mm ✓	16,2 mm = 1,62 cm ✓
Width of the window	1 000 mm	1 000 mm ÷ 50 = 20 mm ✓	20 mm = 2 cm ✓

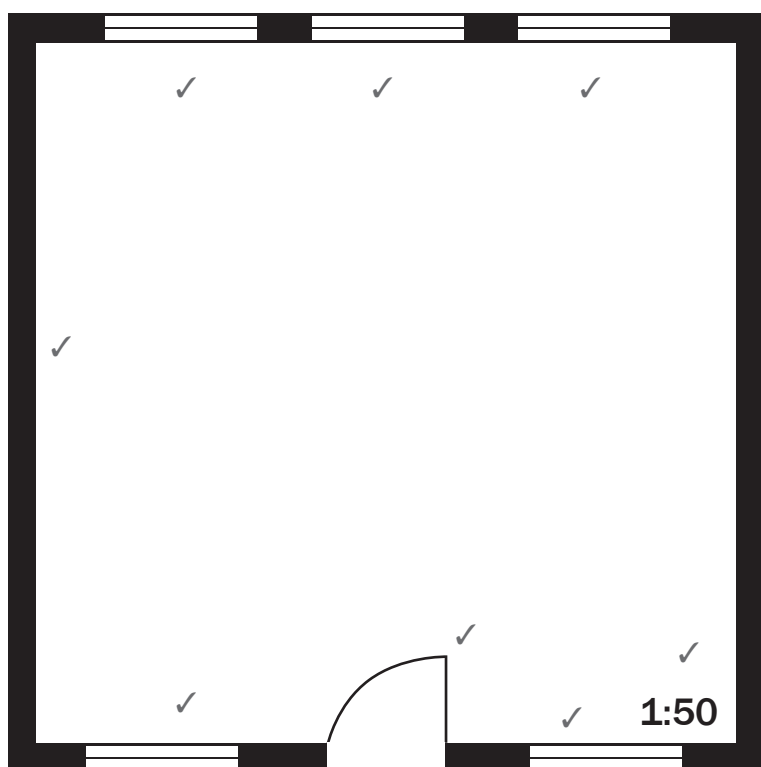

(14)

1. There are 5 windows in total. Each window is 1 000 mm wide.
 $1\ 000\ \text{mm} \times 5 = 5\ 000\ \text{mm}$
 There are 1 000 mm in a metre. ✓
 $5\ 000 \div 1\ 000 = 5\ \text{m}$ ✓ (2)
 2. R 60 per metre $\times 5\ \text{m} = \text{R } 300$ ✓ (1)
 3. Area = length \times breadth ✓
 $= 5\ \text{m} \times 5\ \text{m}$
 $= 25\ \text{m}^2$ ✓ (2)
 4. $25\ \text{m}^2 \div 4\ \text{m}^2 = 6,25$ boxes ✓
 You cannot purchase 6,25 boxes of tiles. You will have to buy 7 boxes. ✓ (2)
 5. $7 \times \text{R}150 = \text{R } 1\ 050$ ✓ (1)
- [22]**



The following question papers will assist to ensure further understanding about the SCALE concepts. Skills that were not included on the notes/ worked examples will be learnt through the interaction with these papers.

Mathematical Literacy P1 Feb/March 2011 Q 6.1.4

Mathematical Literacy P1 Feb/March 2012 Q 4.2.2

Mathematical Literacy P1 Feb/March 2013 Q 4.3.2

Mathematical Literacy P2 Feb/March 2012 Q 1.1.1

Mathematical Literacy P2 Feb/March 2013 Q 2.1.3







Mathematical Literacy P1 November 2012 Q 3.3.4 & 5.1.2

Mathematical Literacy P1 November 2013 Q 4.2.6

Mathematical Literacy P2 November 2010 Q 2.1.3 (b)

Mathematical Literacy P2 November 2012 Q 4.1.2

Symbols are often used on maps as a short-hand way of representing information. Some symbols that you may be familiar with are:

Lift	Escalator	Stairs	Toilets	Restaurant	Disabled Access
					



Activity 4: Navigating a shopping mall

Study the map of the ground floor of a shopping centre and answer the questions that follow.

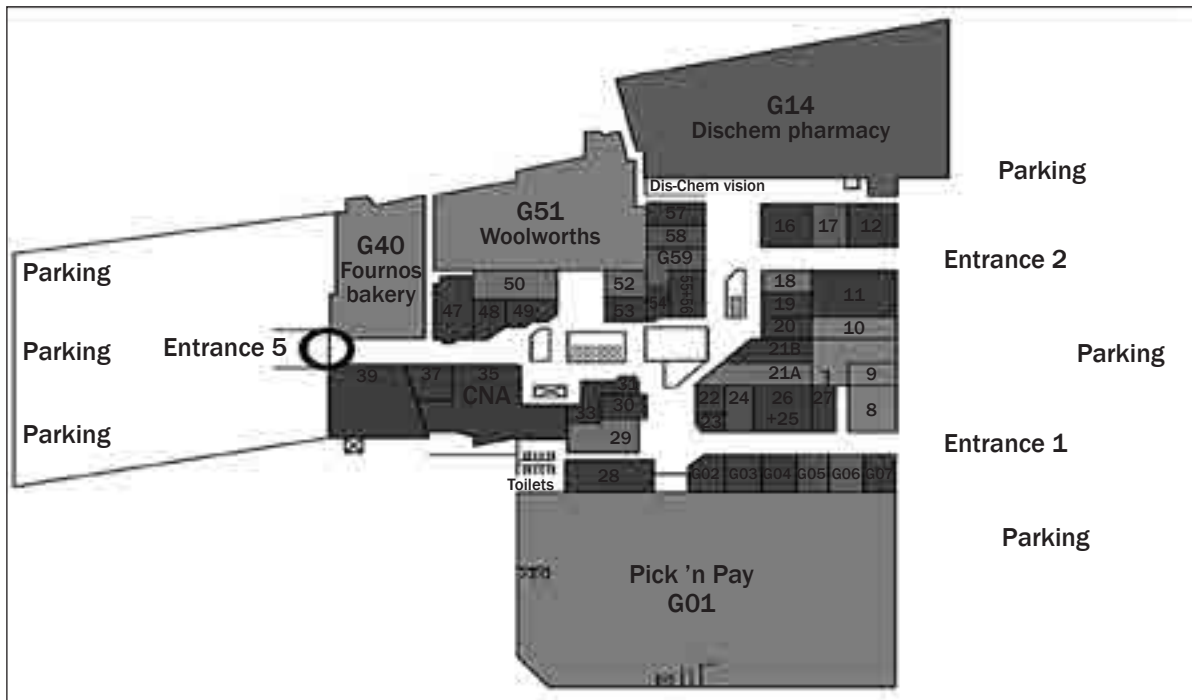

1. You want to go to Shop 37 to buy new shoes. What store will you find next to it? (1)
2. What does “G51 Woolworths” mean on this map? (1)
3. Do you think this shopping centre has more than one floor? Explain your answer. (1)
4. Where should you park if you want to go to Fornos bakery to buy some fresh bread? (1)
5. Name two stores you could buy stationery from and describe how you would get to each of them from Entrance 1. (2)
6. If you are at Entrance 2, explain how you would get to the toilets. (4)
7. You are standing at the entrance of Dis-Chem. Your friend arrives at Entrance 5 and wants to meet you. Give your friend directions to explain where they will find you. (6)

[16]

Solutions

1. Shop 35: CNA or shop 39. ✓ (1)
2. Woolworths is Shop 51 on the ground floor. ✓ (1)
3. Yes - there is an escalator indicated on the map. ✓ (1)
4. Near Entrance 5. ✓ (1)
5. CNA: Go straight towards Shop 29. Turn right, go left around the corner at Shop 31. Go straight. CNA will be on your left. ✓ (1)
Pick n Pay: Go straight passing shops G07 - G02 on your left. Turn left into the entrance of Pick n Pay. ✓ (1)
6. Go straight, turn left at Shop 18, in front of the stairs. ✓ Walk past shops 18 - 23, turn right, ✓ between shops 28 and 29. Go straight down this passageway, ✓ and the toilets are at the end. ✓ (4)
7. Go straight, keeping to the left of the escalators in the middle. ✓ Pass the entrance to Woolworths on your left. ✓ Pass shops 53 - 56 (on your left) ✓ and then turn left in front of the escalators/stairs. ✓ Go straight, passing shops G59, 58 and 57. ✓ Dis-Chem will be in front of you. ✓ (6)

[16]

Using a road map

We will work through an example of a trip from Kimberley to Beaufort West.

We can see the route on a national map first. Using the bar scale, we can estimate very roughly that the distance is about 500 km. You can also see that the journey will be roughly in a south-westerly direction.



As you travel, you should check that you have followed the directions correctly by looking for new reference points on the map.



Before beginning your trip:

- Find your present location, and where you are going by matching landmarks to the map. On the map alongside we can see that you need to take the N12 (national road 12) from Kimberley.
- Look at the route you are going to follow. Plan the trip by tracing routes between the two points. This also helps you to become familiar with the places you will travel through and to plan where you will stop for fuel. For example, after leaving Kimberley, you will travel through Spytfontein, Modderivier and you will pass Ritchie, Heuningneskloof and Belmont before driving through Hopetown and Strydenburg.
- Estimate how long it will take you to get from town to town. The distances are marked in small numbers between the towns. For example, in the portion of a road map shown alongside, the distance from Kimberley to Spytfontein is 20 km and from Spytfontein to Modderivier is 16 km.



Activity 5: Using a road map

Clyde lives in Graaff-Reinet. He regularly travels to Adelaide to visit his parents. He also has a family that lives in Jansenville. The map indicates the names of regional roads in rhombuses and main roads in rectangles. National roads are indicated in a pentagon. The actual kilometre distance between sections of the road is also indicated on the map.

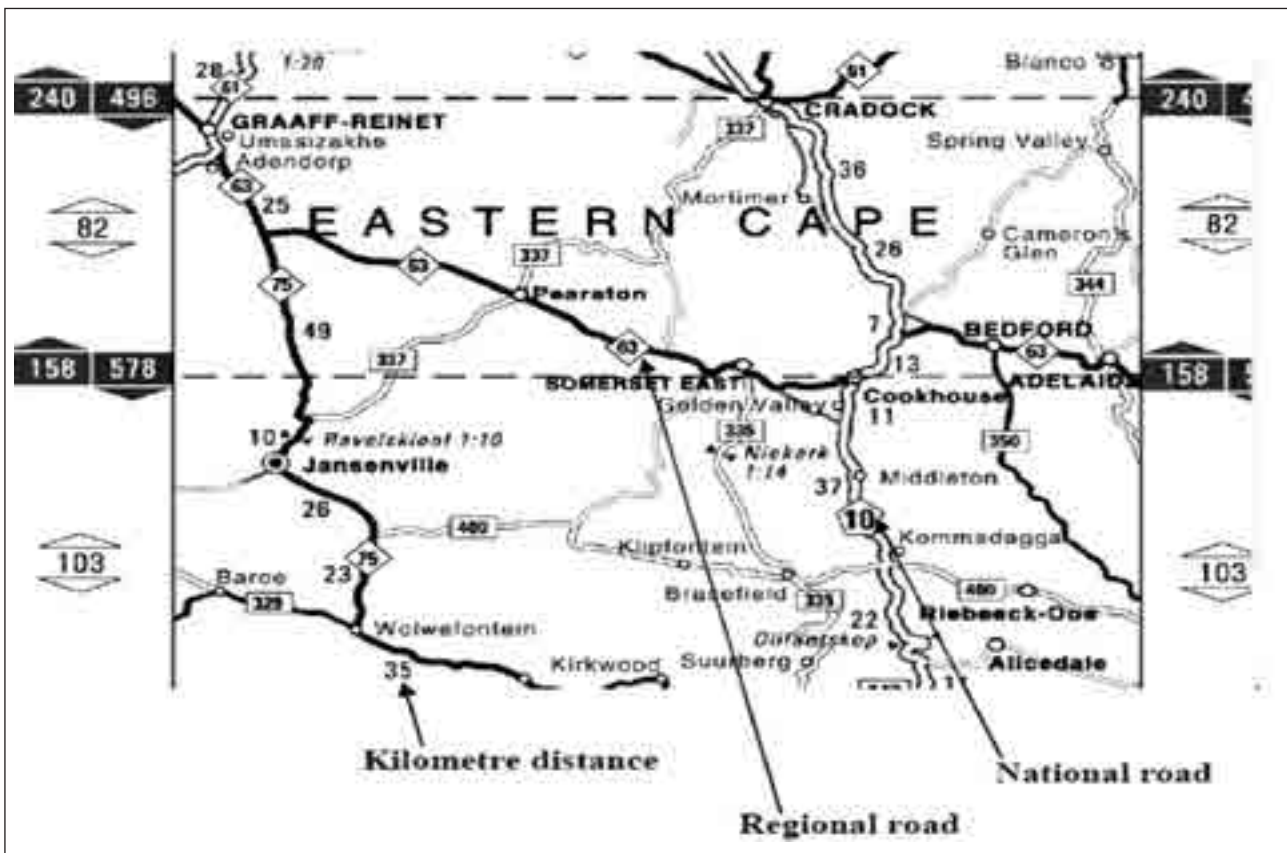

Use the map on the previous page to answer the questions that follow.

1. Name the regional road Clyde would use to travel from Graaff-Reinet to Adelaide. (1)
2. Name THREE towns and/or cities that Clyde would pass on his way to Adelaide. (3)
3. Calculate the actual distance between Graaff-Reinet and Jansenville. (4)
4. In which general direction is Pearston from Jansenville? (1)
5. A distance between two points on the map is 3 cm. The actual (real-life) kilometre distance between the two points is 15 km. Determine the scale used on the map. (3)

[12]

Solutions

1. R63 ✓ (1)
2. Pearstoh; Somerset ✓ East; Cookhouse; Bedford (any three) ✓ (3)
3. $25 \text{ km} + 49 \text{ km} + 10 \text{ km} = 84 \text{ km}$ ✓ (4)
4. North-easterly ✓ OR NE ✓ (1)
5. $3 \text{ cm} : 15 \text{ km}$ ✓
 $= 3 \text{ cm} : 1\,500\,000 \text{ cm}$ ✓
 $= 1 : 500\,000$ ✓ (3)

[12]

Elevation Maps

An elevation map is any map which shows the different elevations of an area. This can be as simple as printing elevations on a road map or as complex as topographical mapping. Most people are actually seeking a simple topographical map when they ask for an elevation map, as they want to see elevation in relationship to geographical features such as rivers, forests, and canyons.

<http://blog.maps.com/wordpress/maps/elevation-map/whatisaelevationmap/#sthash.KwLiaenk.dpuf>



Worked example 5

Comrades Marathon

ROUTE & DISTANCE

It is a "DOWN RUN" starting at the City Hall in Pietermaritzburg and finishing at The Kingsmead Cricket Stadium in Durban. The Comrades Marathon race distance is approximately 89,9 km.

DATE AND TIME OF RACE

The race will be run on Sunday, 1 June 2014 starting at 05h30 and finishing at 17h30. The race is run from 'gun to gun'.

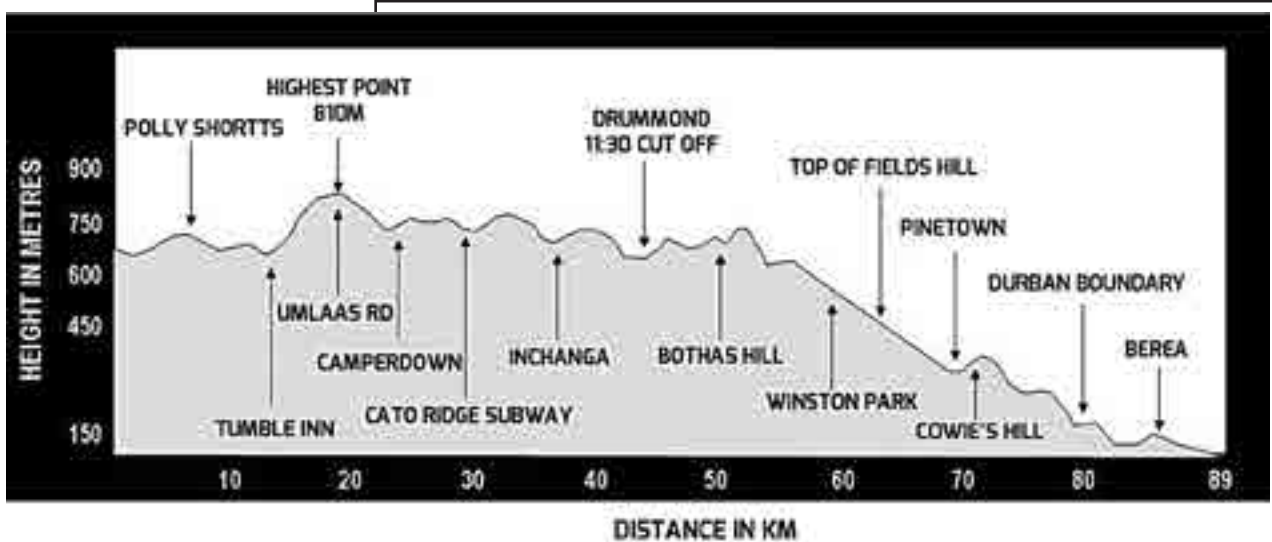

$$\text{Average speed} = \frac{\text{total distance covered}}{\text{time taken}}$$

- a) Which place/road in the maps represents:
- Half the distance of the race?
 - The highest point of the route?
- b) Jomo reaches Durban Boundary 10 hours after the start of the race.
- At what time did he reach Durban Boundary?
 - Determine the distance covered by Jomo.
 - Calculate Jomo's average speed (in km/h) during this period?

Solutions

- a) (i) Drummond
(ii) Umlaas Rd
- b) (i) 15h30
(ii) 80 km
(iii) Average speed = total distance covered/time taken
= 80 km/10 h
= 8 km/h

Jomo's average speed was 8 km/h.



The following question papers will assist to ensure further understanding about the MAPS concepts. Skills that were not included on the notes/ worked examples will be learnt through the interaction with these papers.

- Mathematical Literacy P1 Feb/March 2010 Q 5.1
- Mathematical Literacy P1 Feb/March 2011 Q 6.1
- Mathematical Literacy P1 Feb/March 2012 Q 6
- Mathematical Literacy P2 Feb/March 2012 Q 4
- Mathematical Literacy P1 November 2012 Q 3.3
- Mathematical Literacy P1 November 2013 Q 4.2
- Mathematical Literacy P2 November 2010 Q 2.1
- Mathematical Literacy P2 November 2011 Q 3
- Mathematical Literacy P2 November 2012 Q 1 & Q 4
- Mathematical Literacy P2 November 2013 Q 2.1 & Q 2.2

5.3 Plans

5.3.1 Assembly diagrams and instructions

When you buy certain items from a shop, for example a piece of furniture, sometimes the item is not fully assembled. You would then have to assemble the item yourself. These items usually come with a set of instructions and/or an annotated diagram.

It is vital to ensure that you understand each symbol in the assembly instructions.



When we refer to “instructions for assembling”, we are referring to words (usually short sentences) describing how to assemble an item. When we refer to “assembly diagrams”, we are referring to annotated (labelled) pictures that explain in detail how we must assemble an item.

e.g. Worked example 6

In the image below, instructions are given in picture form only. Each number on the diagram represents one step in the assembly process. You are given five written instructions below. In the table below, match each written step to the step number you think it describes.

Step number on image	Statement number/description
Step 1	a) Connect the composite video cable to a TV.
Step 2	b) Connect the speaker cables.
Step 3	c) Connect the power cables of the system and TV to AC power.
Step 4	d) Connect the control cable.
Step 5	e) Connect the FM antenna.

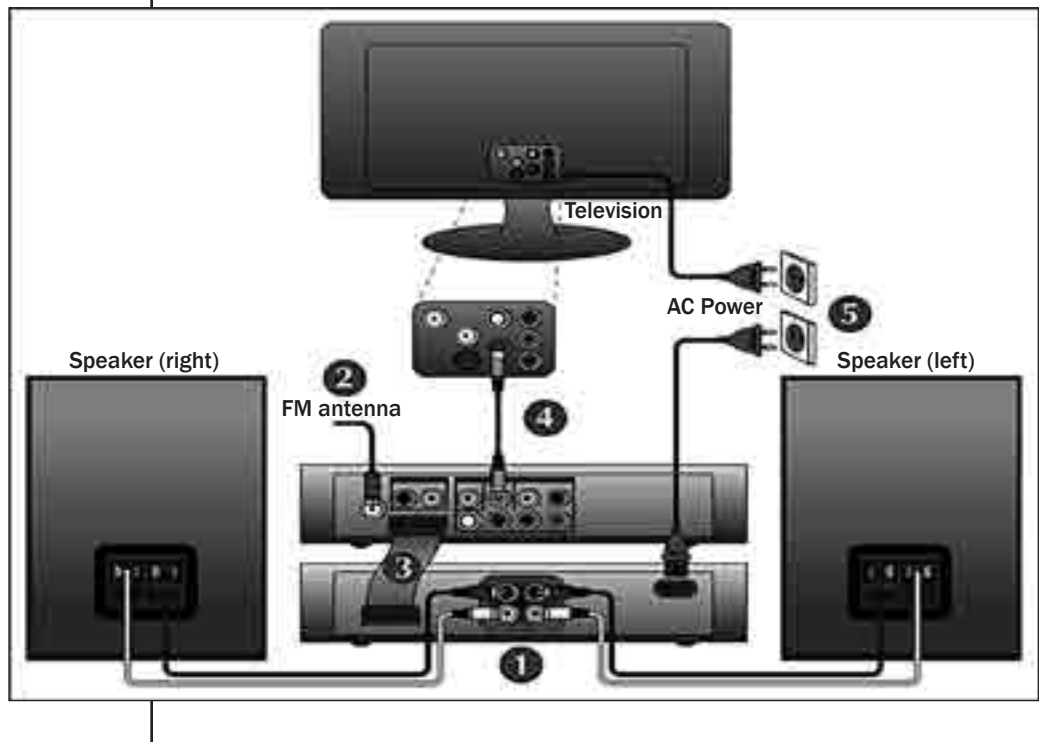

Solution

Step number on image	Statement number/description
Step 1	b) Connect the speaker cables.
Step 2	e) Connect the FM antenna.
Step 3	d) Connect the control cable.
Step 4	a) Connect the composite video cable to a TV.
Step 5	c) Connect the power cables of the system and TV to AC power.

**Worked example 7**

In a group, study the images below showing how to insert a cellphone's SIM card and battery, and write a description of each step, based on the images.

**Solutions**

- Step 1:** Place your fingernail in the cover release opening, lift the back cover of the phone up (1) and pull it back (2) to remove it.
- Step 2:** Lift out the battery by slipping your finger under the side and lifting it up (1) and out (2) of the phone.
- Step 3:** Slide the SIM card into the SIM card socket inside the phone. Make sure that the card's gold contacts face downwards.
- Step 4:** Replace the battery by slipping it back into the phone (1) and pressing it down (2).



Activity 6: Instructions for wiring a plug



1. Study the assembly instructions given below to wire a plug and answer the questions that follow.



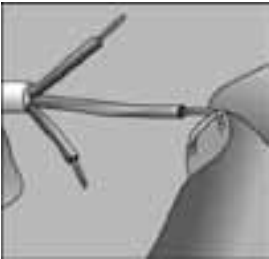

Note:

Do not attempt to wire a plug yourself unless you are supervised by an adult who knows how to do it correctly!



Electrical appliances can kill you if they are not properly wired!

	<ol style="list-style-type: none"> 1. Using pliers, carefully bare the ends of the three wires inside the electrical cord for about half a centimetre, by cutting away the plastic insulation.
	<ol style="list-style-type: none"> 2. Gently twist the strands of copper wire with your fingers until each strand is tight.
	<ol style="list-style-type: none"> 3. Remove the new plug cover by either “snapping” it open or unscrewing it.
	<ol style="list-style-type: none"> 4. Unscrew the little screws on each of the plug's prongs.

	<p>5. Insert the twisted copper wires into the holes in the prongs. The green and yellow wire must always be inserted into the top (largest) prong. The blue wire is inserted into the left prong (sometimes marked with a blue spot or the letter N). The brown wire is inserted into the right prong (sometimes marked with a brown spot or the letter L).</p>
	<p>6. Tighten the little screw on each of the plug's prongs.</p>
	<p>7. Make sure the electrical cord is firmly gripped by the arrester clips at the bottom of the plug.</p>
	<p>8. Replace the cover of the plug.</p>

1. What colour wire must be inserted into the top prong? (1)
 2. What colour wire must be inserted into the left prong? (1)
 3. What colour wire must be inserted into the right prong? (1)
 4. What is the main difference between a 2 prong plug and a 3 prong plug? (2)
 5. Why do you think it is important to wire an electrical appliance correctly? (1)
- [6]**

Solutions

1. The green and yellow wire. ✓ (1)
 2. The blue wire. ✓ (1)
 3. The brown wire. ✓ (1)
 4. A 2 prong plug only has two wires, unlike a 3 prong plug, ✓ which has 3 wires. A two prong plug is also not earthed. ✓ (2)
 5. Appliances that aren't wired correctly can short circuit ✓ and shock you if you touch them. This can be fatal! (1)
- [6]**

5.3.2 Plans and elevations

An elevation shows the front, back or side view of a building.



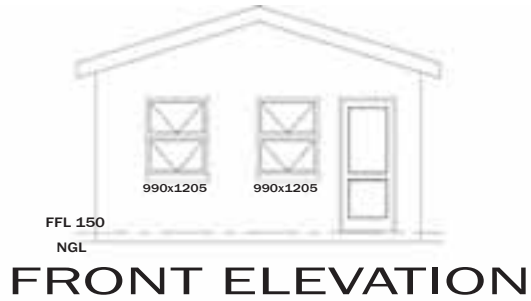
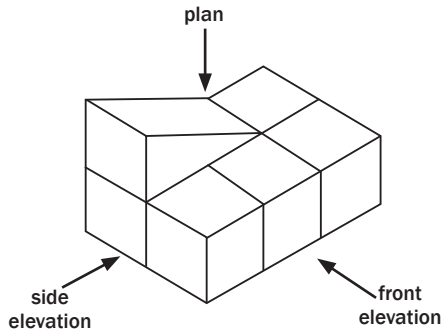





For example, the elevations of a building could look like this:

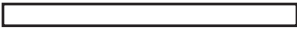

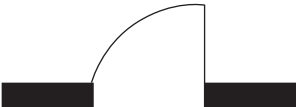
5.3.3 Symbols on a floor plan

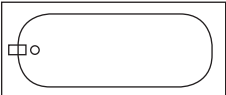
It is important to understand the layout of floor plans. In order to do this, we can use a key (or legend) that describes the symbols most commonly used on floor plans, as in the key given below.

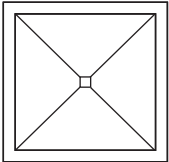
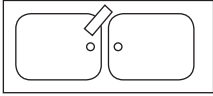
Sometimes the symbols might look slightly different.

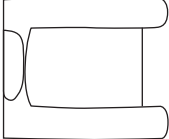
	Solid wall
	Wall that does not reach the ceiling
	Window in a wall
	Door, indicating which way it opens
	Sliding door
	Bath
	Toilet
	Shower
	Double kitchen sink
	Single bed
	Single armchair

5.3.4 Reading floor plans

There is a lot of information on a floor plan. Study at the diagram below to understand all of the given information.

The windows symbol has three lines.
There are seven windows on this plan.

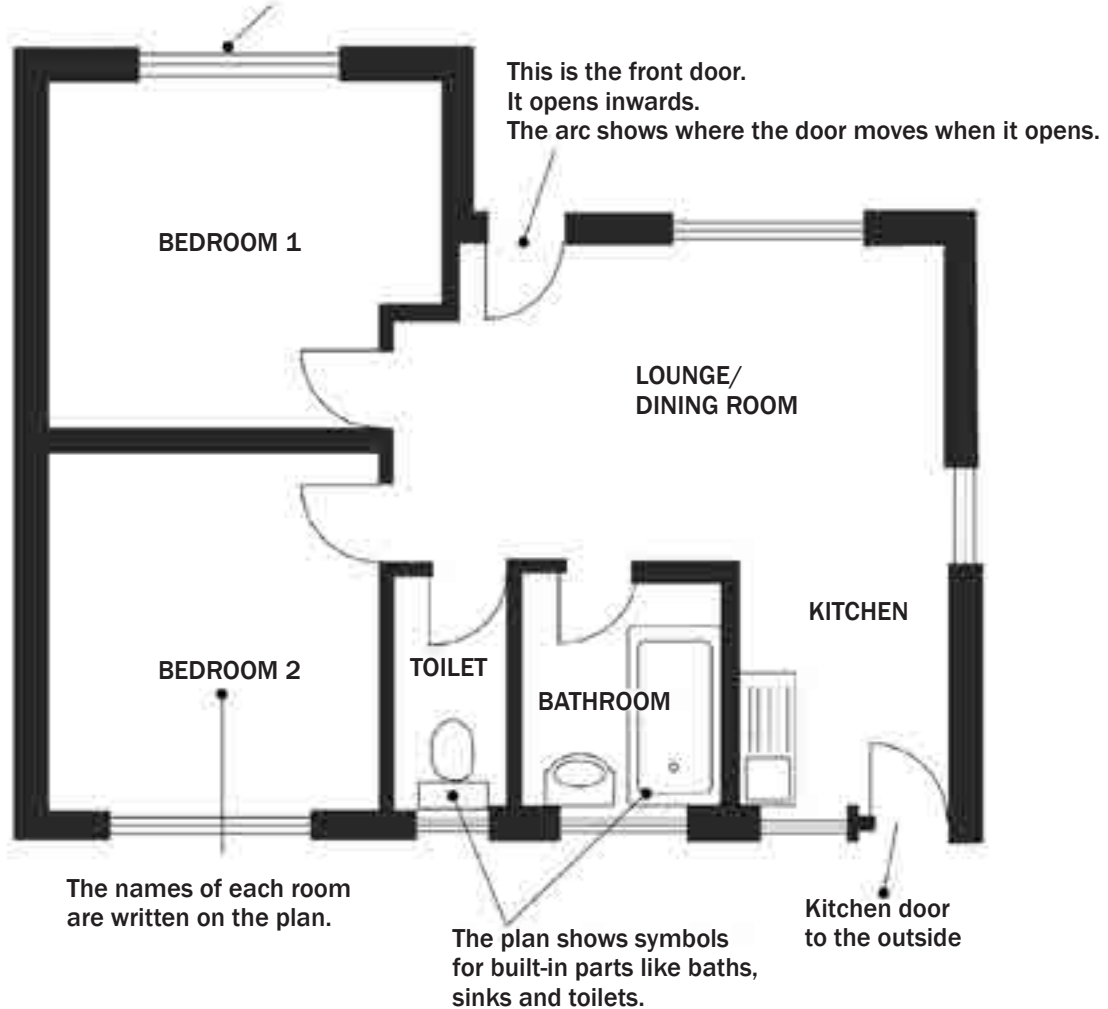

- The floor plan is drawn as if the roof has been lifted off and you're looking down into the building from the top.
- Identify the front entrance to the house: imagine opening the front door and walking into each room on the floor plan.
- Doors and windows are two of the most important parts shown on a floor plan. Windows are shown with three parallel lines in a wall.
- Doors are typically shown as a straight line perpendicular to a wall and an arc that connects this line to the wall. This shows which side has the hinges and which room the door opens into.
- The baths, sinks and toilets are shown on the plan, because they are put in when the house is built. They are called **fixtures**. This means they are built in and can't be moved like we move furniture around.



Worked example 8: Drawing a floor plan

The diagram below is an illustration of a part of the bathroom. No windows or doors are shown. The two walls that aren't visible in the illustration are inside the house.



Use appropriate symbols to draw a rough floor plan of the room in the illustration.

- The plan does not have to be drawn to scale.
- Add a door and a window to your floor plan in any place you think is appropriate.

Solution

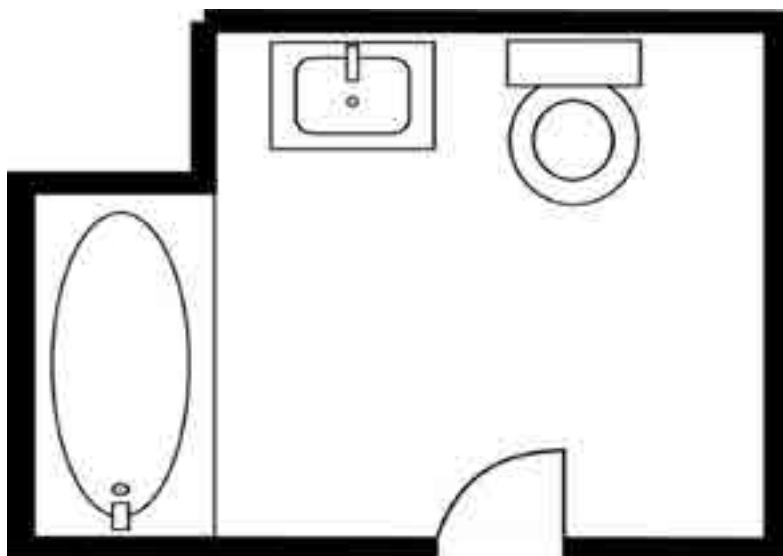



Activity 7: Interpreting a floor plan

Consider the floor plan of a townhouse given below. It contains some errors. Identify as many as you can, and state why each is an error.

[20]

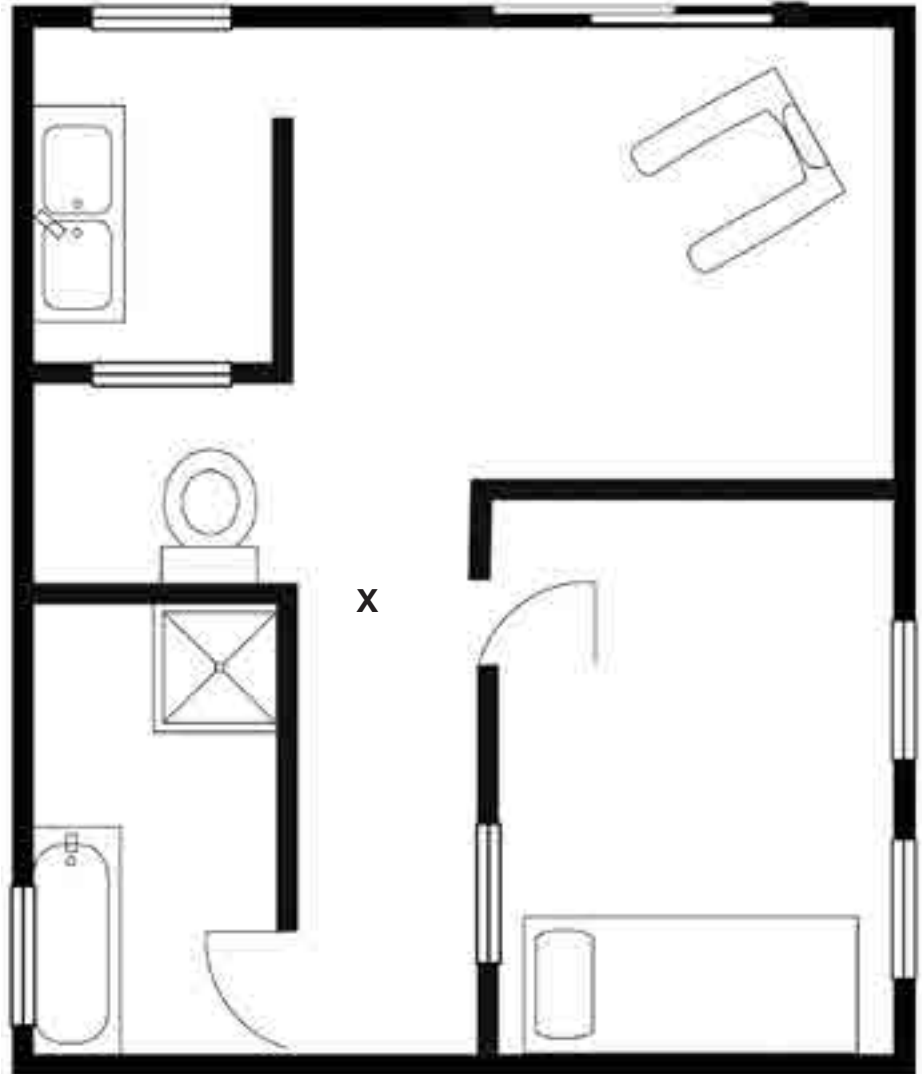

Solution

Room by room:

- The kitchen has a window on the north wall rather than the west wall, meaning that the room will be dark ✓ and there is not enough room for wall cupboard units ✓. As there is a window on the south wall as well, the cupboards can only be above and below the sink ✓, so a person working at the sink will be uncomfortable with the cupboard right in front of their face ✓. The sink also is not in a corner ✓, meaning that there is wasted space in the south of the room ✓, because there's not enough space for a fridge or cupboard there ✓. Furthermore, the placement of the door into the room makes it impossible to put any cupboards on the north wall anyway. ✓ The door into the kitchen is just an opening, which is normal in modern houses.
- The toilet is not against a wall which contains water pipes ✓; toilet pipes always run up the exterior (west, in this case) wall, meaning that the toilet won't work ✓. Furthermore, the toilet does not have a door, which is inappropriate. ✓ Lastly, it is inappropriate to have a window into the toilet from the kitchen ✓. The toilet window is always above the toilet to the outside of the building (with frosted glass). ✓
- The bathroom places the shower in the north-east corner, which means that a pipe to supply hot water would have to run down from the roof in a wall there ✓, which would be risky if someone drilled into the wall to hang a shelf, as it would be hard to guess where the pipe was ✓. Furthermore, a long cold-water pipe will have to run from the west exterior wall to the shower ✓, raising costs ✓ and the same risk of a later accident if the home owner hangs a shelf or cupboard. The shower should probably be on the west wall as well. ✓ The door to the bathroom opens the wrong way ✓; it should open against the south wall ✓. Furthermore, the passage is a waste of space ✓; the bathroom could be bigger and nicer ✓ if the passage was removed and a door into the bathroom was placed where the passage currently starts (next to the bedroom door, marked "X" on the plan).
- The sliding door in the lounge is on the north wall. This is correct, since houses in the southern hemisphere should be north-facing to get sunlight all day into the living spaces. However, there is a large wall on the west wall which should have a window in it to let in more light. ✓
- There is no entrance door into the building apart from the sliding door. ✓ It is conventional to have one into the kitchen ✓ so that laundry can be taken out back rather than through the house.
- The door in the main bedroom does not open correctly at all and/or is not placed correctly ✓. There are no cupboards in this room ✓; they should be on the north wall (of this plan) ✓. There is a window into the passage ✓; this defeats the privacy of the bedroom (you don't want people in the passage looking through a window onto your bed). ✓
- Generally, the orientation of the house is wrong. ✓ The water pipes and water-using rooms (bathroom, kitchen, toilet), should be on the south side ✓, and the bedroom on the north side ✓, so that the bedroom is more cheerful with light all day. ✓

[Any 20]

5.4 Models

Packaging and models

When items are packed into a limited space like a box, cupboard or suitcase, how they are packed often determines how many items can fit into the space. A good example of this is trying to pack everything you need for your school day (like your books, sports equipment and food) into your school bag or backpack.

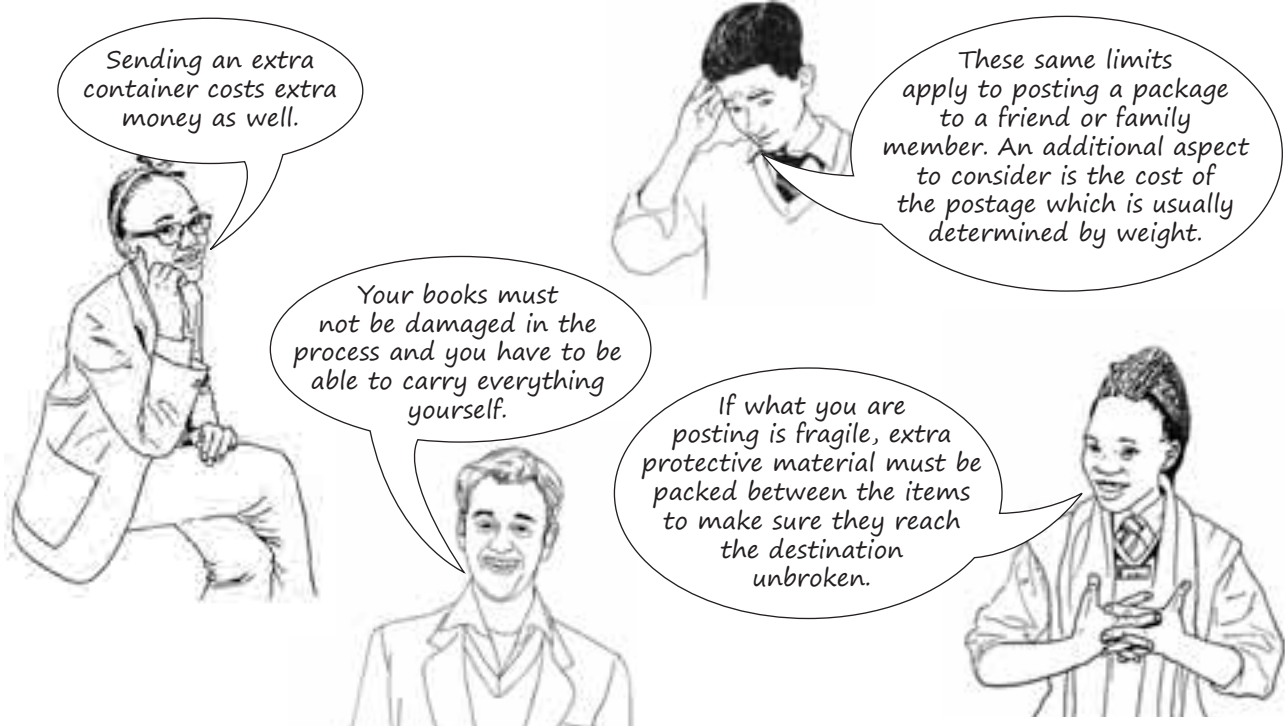

e.g. Worked example 9

Vuyo and Siphó's father own a biscuit business called Biscuits for Africa. It is the June/July school holidays and, to make more pocket money, their father has employed them for one week to help pack the biscuits into boxes so they can be transported to stores.

- Vuyo has to pack small boxes of ginger biscuits into the large shipping boxes for transporting. There are 600 small boxes, and Vuyo's father tells him he can pack 15 boxes of biscuits into one large shipping box. How many large boxes will Vuyo need?
- Siphó has to pack tin cans of chocolate biscuits into the same sized large shipping boxes that Vuyo is given. He is told he can fit 20 cans into one larger box. If there are 500 cans, how many large boxes will Siphó need?
- Each large shipping box costs R5,50. Which will be cheaper to pack: the ginger biscuits in small boxes, or the chocolate biscuits in cans?
- Vuyo's and Siphó's father tells them that each large box can hold a maximum weight of 3,5 kg.
 - If each small box of ginger biscuits weighs 200 g, how many small boxes can Vuyo pack into a bigger box without exceeding the weight limit?
 - If each can of chocolate biscuits weighs 300 g, how many cans can Siphó pack into a bigger box without exceeding the weight limit?

- e) The boys' father orders new large shipping boxes that are 45 cm long and 16 cm wide.
- (i) If the surface area of the bottom of one small box of ginger biscuits is 25 cm^2 ($5 \text{ cm} \times 5 \text{ cm}$), how many small boxes can Vuyo fit into only one layer the new large boxes? Draw a scaled diagram (1 : 100) to demonstrate this packaging arrangement.
- (ii) If the diameter of one round can is 5 cm, how many cans can Siphio fit (only one layer deep) into the new large boxes? Draw a scaled diagram (1 : 100) to demonstrate this packaging arrangement.
- f) Vuyo wants to practise his Maths Literacy skills and rather calculate the area of the bottom of the large box and the small boxes, and divide the larger area by the small one to see how many boxes he can pack. He does the following calculations.
 Area of bottom of one small box = 25 cm^2 .
 $720 \text{ cm}^2 \div 25 \text{ cm}^2 = 28,8 = 28$ boxes.
 This is different to Vuyo's initial calculation in Question 5 a).
 Why do you think Vuyo got a different answer when he calculated the area?

Solutions

- a) $600 \text{ small boxes} \div 15 \text{ per box} = 40 \text{ large boxes}$.
- b) $500 \text{ cans} \div 20 \text{ per box} = 25 \text{ large boxes}$.
- c) Ginger biscuits require 40 large boxes.
 Chocolate biscuits require 25 large boxes.
 Therefore the chocolate biscuits will be cheaper to pack, because they require fewer large boxes.
- d) (i) $3,5 \text{ kg} = 3\,500 \text{ g}$. $3\,500 \text{ g} \div 200 \text{ g} = 17,5$. But Vuyo can't pack half a box of biscuits, therefore we round down to the nearest whole number: Vuyo can pack 17 small boxes of ginger biscuits into one large box.
- (ii) $3,5 \text{ kg} = 3\,500 \text{ g}$. $3\,500 \text{ g} \div 300 \text{ g} = 11,67$. But Siphio can't pack 0,67 cans, therefore we round down to the nearest whole number: Siphio can pack 11 cans of chocolate biscuits into one large box.
- e) (i) Length of large box = 45 cm.
 $45 \text{ cm} \div 5 \text{ cm} = 9 \text{ boxes}$.
 Width of large box = 16 cm.
 $16 \text{ cm} \div 5 \text{ cm} = 3,2 \text{ boxes}$. Vuyo can't pack 0,2 of a box, so we round this down to the nearest whole number, 3 boxes.
 So Vuyo can fit 9 rows of 3 boxes each.
 $9 \times 3 = 27 \text{ boxes}$.
- (ii) Length of large box = 45 cm.
 $45 \text{ cm} \div 5 \text{ cm diameter} = 9 \text{ cans}$.
 Width of large box = 16 cm.
 $16 \text{ cm} \div 5 \text{ cm diameter} = 3,2 \text{ cans}$. Siphio can't pack 0,2 of a can, so we round this down to the nearest whole number: 3 cans.
 So Siphio can fit 9 rows of 3 cans each. $9 \times 3 = 27 \text{ cans}$.
 Siphio can fit 27 cans of chocolate biscuits into the new large shipping boxes.
- f) Calculating the area of the bottom of the large and small boxes does not take into account the shape of the boxes. We can see from the scale diagram in Question 5 a) that it is only possible to fit 27 small boxes into the larger box. 3 boxes in a row ($3 \times 5 \text{ cm} = 15 \text{ cm}$) do not fit exactly into the large box (16 cm wide) - there is a small space left which we cannot fill with boxes due to their shape. When dealing with packaging, it is very important to take shapes into account - we cannot just do area calculations without testing our packaging arrangement in reality!





The following question papers will assist to ensure further understanding about the MODELS concepts. Skills that were not included on the notes/ worked examples will be learnt through the interaction with these papers.

Mathematical Literacy P1 Feb/March 2013 Q 3.2

Mathematical Literacy P2 Feb/March 2012 Q 5.2.2

Mathematical Literacy P1 November 2010 Q 2.1

Mathematical Literacy P1 November 2011 Q 4.2

Mathematical Literacy P1 November 2012 Q 4.2

Mathematical Literacy P2 November 2013 Q 1.4 & Q 4.1



Data handling

Data is a collection of numerical figures and information used in research.

Data handling involves the following processes:

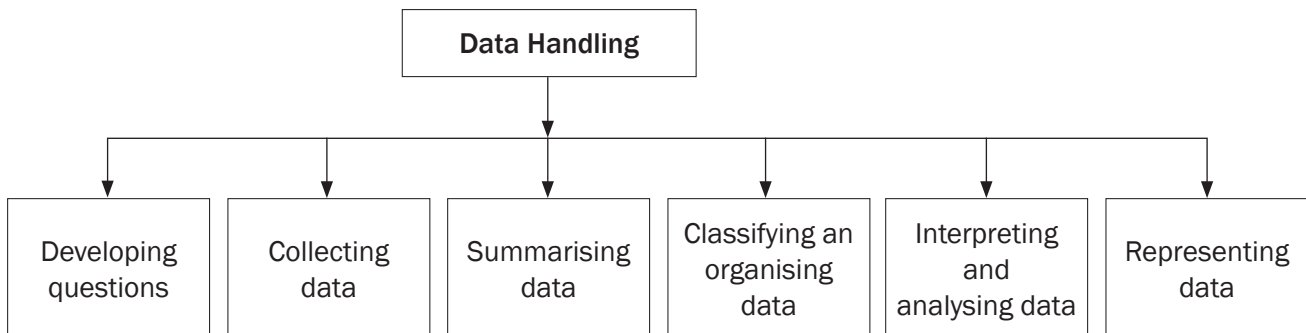

6.1 Developing research questions

Before we start the research process, we need to make sure that we state the aim of the research clearly, in a way that can be measured. The aim of the research is then written as a research question. This will guide us to formulate the tool to be used to collect the data. Data may be collected from a population. Open-ended and closed questions may be used.

In an **open-ended** question, the answer is usually the opinion of the respondent and the respondent can answer in their own words. In this way you can gain insightful data and avoid receiving answers that are biased. A disadvantage of this type of question is that respondents might leave it out if it takes too long to answer.

Closed questions could give options for the respondent to choose from, which is convenient because they can simply tick the right box. A disadvantage of this type is that, when an option provided does not accommodate all respondents, this may lead to a situation where some of the questions are not answered.

6.2 Collecting data

The aim of the research influences the choice of the sample and the method of collecting data. The population is a group that the data is collected from, e.g. Gauteng Matric learners. If the population is large, a sample may be used. A sample is a portion chosen to represent the population e.g. learners from 10 schools in Gauteng to represent the matriculants of Gauteng.

The choice of sample can have an effect on the reliability of the data and could even lead to sample bias. Sample bias occurs when the sample is not representative of that population, e.g. if the selected learners are from city schools only, then the sample will be biased because they might not share similar characteristics with learners from townships and farms schools. Random sampling is used to minimise sample bias. However it might still lead to sample bias, if the random sample is composed of learners from township schools only.

So demographic factors, race, gender, age, etc. should be controlled when sampling.

The method of collecting data will help us to identify the most appropriate tool to be used when collecting the data.

There are three methods of collecting data:

- **Observation:** This is the method of collecting data by watching and recording the results. The advantage of this method is that you don't interact with people to get the response.
- **Questionnaire:** This is a list of questions used to collect data from the respondents. Participants do not have to identify themselves. The advantage of using this method is that you get the information directly from the participants.
- **Interview:** The interviewer asks the interviewee questions and records the response. The advantage of this method is that the interviewer may ask further questions if the response is vague.

6.3 Classifying and organising data

- Organising data is taking information and arranging it into some kind of order (such as ascending or descending order).
- Classifying data means organising it in groups or classes, based on some common feature.

Data can be organised by using tally marks. These are a way of counting how many of each group there are. They are used when the data is discreet.



Worked example 1

An Audi sales person has ordered cars from their plant in Germany. The table below shows the number of cars they received.

Colour	Red	White	Silver	Black
Model				
A3	2	5	4	3
A4	3	2	3	6
S3	4	3	5	5
Q7	1	4	4	3
R8	2	3	1	4

Use the information provided above to construct a tally table for A3 cars.

Solution

Use vertical lines (tally marks) to represent the specific colour; the fifth tally mark should be drawn the across the 4 tally marks.

Colour	Frequency	Tally
Red	2	
White	5	
Silver	4	
Black	3	



Worked example 2

This grouped frequency table shows the heights of seedlings (young plants) in different categories.

Height of seedling (mm)	Frequency
10–14	3
15–19	6
20–24	7
25–29	5
30–34	4

- How many plants were measured altogether?
- How many plants are less than 20 mm high?
- How many plants are more than 24 mm high?
- What percentage of seedlings are below 25 mm?
- How many plants are at least 25 mm high?

Solutions

- $3 + 6 + 7 + 5 + 4 = 25$ plants were measured altogether.
- $3 + 6 = 9$ plants are less than 20 mm high.
- $5 + 4 = 9$ plants are more than 24 mm high.
- $16 \div 25 \times 100\% = 64\%$
- There are nine plants that fall into the intervals of 25 mm or longer.



Activity 1: Working with frequency tables

The Geography examination marks, expressed as a percentage, of 52 learners were recorded as follows:

54	67	83	34	49	56	78	89	90	79	20	49	50
70	89	57	27	48	56	65	70	22	98	89	29	56
47	95	49	67	89	48	46	89	63	75	45	50	58
73	67	45	76	70	38	46	37	47	36	38	99	100

In the exam you are required to show results in terms of seven performance levels rather than percentages. As a result, the subject internal moderator who is analysing the results needs to work out the number of learners per performance level. Complete the frequency table below to work out the number of learners per performance level. [14]

FREQUENCY TABLE : LEARNER PERFORMANCE IN GEOGRAPHY			
PERFORMANCE LEVEL	PERCENTAGE RANGE	TALLY	FREQUENCY
1	0 to 29		
2	30 to 39		
3	40 to 49		
4	50 to 59		
5	60 to 69		
6	70 to 79		
7	80 to 100		

Solutions

Frequency table : learner performance in geography			
Performance Level	Percentage Range	Tally	Frequency
1	0 to 29	✓	4 ✓
2	30 to 39	++++ ✓	5 ✓
3	40 to 49	+++ +++ ✓	11 ✓
4	50 to 59	+++ ✓	8 ✓
5	60 to 69	+++ ✓	5 ✓
6	70 to 79	+++ ✓	8 ✓
7	80 to 100	+++ +++ ✓	11 ✓

[14]

6.4 Summarising data

After data has been collected, classified and organised it is not always possible to mention every piece of data in a report. Instead we summarise data by describing the whole data set using just a few numbers. Summarising data also makes it easier to analyse the data later. Data can be summarised by using measures of central tendency or measures of spread.

6.4.1 Measures of central tendency and measures of spread

A measure of central tendency is a single value that attempts to show a central position of a set of data. There are three types of measures of central tendency: mean, mode and median.

Mean

The mean is the most common measure of central tendency that is used, but it can be easily influenced by high or low numbers in the data set. It is also known as the average. It is calculated by adding all the values together and dividing by the number of values in the data set.

Median

The median is the middle number in the data set. To determine the median, you have to write all the numbers in the data set from the smallest to the highest and the number in the middle will be your median. If there is more than one number in the middle (i.e. if the data contains an even number of data values) add the two numbers in the middle and divide the answer by 2.

Mode

The mode is the data value that appears most often in a set of data. No calculation is needed to find the mode. You just find the value that appears most frequently. If no number appears more than the other numbers, then there is no mode.



Worked example 3

The principal of Hills Primary School compiled data of the number of learners who receive social grants in each class.

He arranged these numbers in ascending order, as follows:

0	0	1	1	1	2	2
2	3	3	3	3	4	4
5	5	6	6	6	7	7

- a) How many different classes are there at Hills Primary School?
- b) Determine:
- the mode
 - the median
 - the mean

Solutions

- a) 21 (Count how many numbers are in the data set)
- b) (i) Mode = 3 (the number that appears most in the data set)
- (ii) Median = 3 (the middle number in the data set)
- (iii) Mean = $\frac{0+0+1+1+1+2+2+2+3+3+3+3+4+4+5+5+6+6+7+7}{21}$
- $$= \frac{71}{21}$$
- $$= 3,38$$

(Add all the numbers in the data set and divide by the total number of the data set.)

e.g. Worked example 4

Thembeke compared the monthly salaries of the employees at two call centres, one in Greytown and the other in Johannesburg.

The following are the monthly salaries, in rand, earned by call-centre agents:

Greytown

4 200 4 320 4 500 4 650 4 650 4 650 5 500 5 650 7 250

Johannesburg:

5 500 5 525 5 980 6 250 6 250 6 250 6 300 7 800 8 200 8 900

- How many employees are working at the Johannesburg call centre?
- Calculate the average (mean) salary earned at the Greytown agency.
- Write down the median monthly salary earned at the Johannesburg agency.
- What is the modal salary earned at Greytown?
- Find the median monthly salary of the employees in both agencies.

Solutions

- a) 10 (count how many numbers are in the data set)
- b) Mean = $\frac{4\,200 + 4\,320 + 4\,500 + 4\,650 + 4\,650 + 4\,650 + 5\,500 + 5\,650 + 7\,250}{9}$
- $$= \frac{45\,370}{9}$$
- $$= 5\,041,11$$

(Add all numbers in the data set (Greytown) and divide by 9.)



When answering questions on data handling where two or more data sets are given, it is advisable to underline key words (e.g. in order to choose the correct data set for the question, underline the town for the data set that you have to use).

- c) (Since there are ten numbers in the data set, add the two middle numbers and divide by two.)

$$\begin{aligned}\text{Median} &= \frac{6\,250 + 6\,250}{2} \\ &= \frac{12\,500}{2} \\ &= 6\,250\end{aligned}$$

- d) Mode = 4 650 (the number that appears most in the Greytown data set)
e) Start by arranging all of the numbers into one data set in ascending order.

4200 4320 4500 4650 4650 4650 5500 5500 5525 **5650** 5980 6250 6250 6250 6300 7250 7800 8200 8900

The median is 5 650.



Activity 2: Measures of central tendency

1. Information for question 1

Thandeka has a shop with a scrapbooking department and a toy department. She kept a record of the ages of the customers who visited the two departments on a particular day.



Scrapbooking is a hobby which involves cutting and pasting photos, pictures and other decorative items into a book.

Ages of customers who visited the scrapbooking department

35	60	46	57	54
34	60	54	56	46
47	67	65	54	45

Ages of customers who visited the toy department

5	15	25	7	36	21	70
20	17	6	15	65	9	15

1. a) Arrange the ages of the customers who visited the toy department in ascending order. (1)
- b) Determine the mode of the ages of customers who visited the scrapbooking department. (1)
- c) Calculate the mean age of the customers who visited the scrapbooking department. (3)
- d) Determine the median age of customers who visited the toy department. (4)
- e) How many customers visited the toy department? (1)
- f) Calculate the percentage of customers older than 50 years who visited the scrapbooking department. (1)

[11]

2. The table below shows the results of the games played by 16 teams who are playing against each other to win the league.

Absa Premiership								
Pos	Team	Pld	W	D	L	GF	GA	Pts
1	Kaizer Chiefs	19	13	4	2	31	12	43
2	Mamelodi Sundowns	19	10	4	5	33	21	34
3	Bidvest Wits	18	10	4	4	23	13	34
4	SuperSport United	20	9	5	6	28	22	32
5	Orlando Pirates	17	9	3	5	21	13	30
6	AmaZulu	21	7	7	7	20	27	28
7	Platinum Stars	18	7	6	5	19	18	27
8	Bloem Celtic	19	6	8	5	25	24	26
9	Ajax Cape Town	20	7	5	8	20	22	26
10	Moroka Swallows	18	6	5	7	22	22	23
11	University of Pretoria	20	7	2	11	19	21	23
12	Black Aces	18	6	5	7	16	20	23
13	Maritzburg Utd	19	5	5	9	19	25	20
14	Polokwane City	19	5	4	10	21	26	19
15	Free State Stars	18	4	4	10	14	26	16
16	Golden Arrows	19	4	1	14	16	35	13

Key: **Pld**(games played) **W**(games won) **D**(games drawn) **L**(lost games) **GF**(goal for) **GA**(goals against) **Pts**(points)

- 2 a) How many teams do we have on the Absa Premiership league? (1)
- b) How many points does the last team on the league have? (1)
- c) How many games did the first team on the league play (Pld)? (1)
- d) Which team(s) played the least number of games? (1)
- e) Calculate the mean for the number of games played. Give your answer to the nearest whole number. (4)
- f) Determine the median of the “goal against” data set (GA). (3)
- g) Write down the mode for the points scored (Pts). (1)



The reason that we have all three measures: mean, median and mode, is because they can give us different information.

[12]

Solutions

1. a) 5 6 7 9 15 15 15 17 20 21 25 36 65 70 ✓ (1)
- b) Mode = 54 ✓ (1)
- c) Mean = $\frac{35+34+47+60+60+67+46+54+65+57+56+54+54+46+45}{15}$ ✓
 $= \frac{780}{15}$ ✓
 $= 52$ ✓ (3)
- d) 5 6 7 9 15 15 15 17 20 21 25 36 65 70 ✓
Median = $\frac{15+17}{2}$ ✓
 $= \frac{32}{2}$ ✓
 $= 16$ ✓ (4)
- e) 14 ✓ (1)
- f) $\frac{9}{15} \times 100 = 60\%$ ✓ (1)

[11]

2. a) 16 teams ✓ (1)
- b) 13 points ✓ (1)
- c) 19 games ✓ (1)
- d) Orlando Pirates ✓
- e) Mean = $\frac{19+19+18+20+17+21+18+19+20+18+20+18+19+19+18+19}{16}$ ✓
 $= \frac{302}{16}$ ✓
 $= 18,88$ ✓
 ≈ 19 ✓ (4)
- f) Median (first arrange the numbers in an ascending order)
12 13 13 18 20 21 21 22 22 22 24 25 26 26 27 35 ✓
 $(22 + 22) \div 2$ ✓
 $= 44 \div 2$
 $= 22$ ✓ (3)
- g) Mode = 23 ✓ (1)

[12]



Worked example 5

The department of trade and industry has funded 1 internship student from Gauteng to study engineering at the University of Toronto in Canada. Mr Kasmal, the project co-ordinator has decided to use the learner's marks in the table below, to choose the best learner.

Help Mr Kasmal to choose the best learner by calculating the mean, median and mode of the 2 learners' results.

Subject	Internship student A	Internship student B
Mathematics	95	95
Physical Science	93	93
Life Sciences	69	72
Life Orientation	87	87
English	90	90
Home Language	92	89
Geography	90	90

Solution

Internship student A	Internship student B
$\text{Mean} = \frac{95+93+69+87+90+92+90}{7}$ $= 88$	$\text{Mean} = \frac{95+93+72+87+90+89+90}{7}$ $= 88$
69 87 90 90 92 93 95 Median = 90	72 87 89 90 90 93 95 Median = 90
Mode is 90	Mode is 90

The measures of central tendency are the same for the two learners. In this case, these cannot be used to determine the best candidate.

The measures of spread can then be used to make the choice by analysing the spread of marks, as discussed on the next page.

6.4.2 Measures of spread

Range

The range is the difference between the largest (highest) and the smallest (lowest) values.

The range is a measure of spread because it tells you how spread out the data values are.

A small range suggests that the values are grouped closer to the median, while a bigger range suggests that the values are more spread out.

$$\text{Range} = \text{highest data value} - \text{lowest data value}$$



Worked example 6

Find the range of the number of death fatalities that occurred over 6 months on the N4 highway: 3; 7; 8; 5; 4; 10.

Solution

The lowest value is 3, and the highest is 10, so the range = $10 - 3 = 7$.

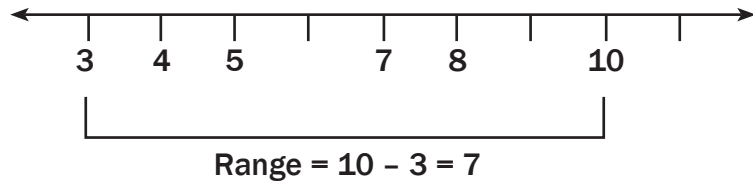

Measures of spread are used to determine how spread out the data is. We have the following measures of spread: range, quartiles and percentiles. These are used together with measures of central tendency to analyse and interpret data.

The range only indicates the spread between the lowest and highest values. This might be misleading if only the minimum and the maximum values are spread apart and the other values are grouped together.



Worked example 7

In the data: 2, 75, 79, 83, 86, 86, 89, 99, the range will be: $99 - 2 = 97$, which might give the wrong interpretation that the data is spread apart. To overcome outlier values, quartiles may be used to analyse the data.

(An outlier is an extremely low or extremely high value.)

Quartiles

This is the division of data into 4 equal parts. The data is divided into four portions of 25% each.

To determine the quartiles, first divide the information into 2 equal parts to determine the median (Q_2), then divide the lower half into 2 equal parts, so that the median of the first half is the lower quartile (Q_1). Then divide the upper half into 2 equal parts, so that the median of the second half is the upper quartile (Q_3).

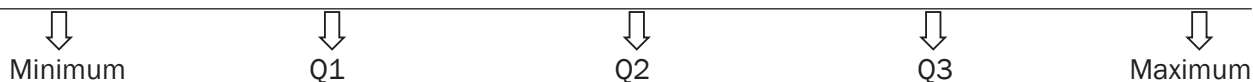

Data can be summarised using 5 values, called the five number summary, i.e. the minimum value, lower quartile, median, upper quartile, and maximum value.

Interquartile range

This is the difference between the upper quartile and the lower quartile.

It indicates the spread between the lower part of the data and the upper part of the data.



Worked example 8

The following data has been released by Statistics South Africa on fatal crashes for November and December 2011.

MONTH	GP	KZN	WC	EC	FS	MP	NW	LIM	NC
NOV	200	156	77	112	73	75	57	81	21
DEC	182	227	107	135	90	109	78	120	32

Use the given table to determine the five number summary and the interquartile range for each month.

First arrange the data for each month in ascending order.

Determine the minimum and the maximum values.

Determine the median (quartile 2).

Then determine quartile 1 and quartile 3.

Solutions**November:**21 57 73 75 **77** 81 112 156 200

Minimum : 21

Maximum : 200

Median (quartile 2) : 77, divides the data into 2 equal halves

Quartile 1 divides the lower half of the data into 2 equal parts

$$\begin{aligned}\text{Quartile 1} &= \frac{57+73}{2} \\ &= 65\end{aligned}$$

Quartile 3 divides the upper half of the data into 2 equal parts

$$\begin{aligned}\text{Quartile 3} &= \frac{112+156}{2} \\ &= 134\end{aligned}$$

$$\begin{aligned}\text{Interquartile range} &= Q_3 - Q_1 \\ &= 134 - 65 \\ &= 69\end{aligned}$$

December:32 78 90 107 **109** 120 135 182 227

Minimum : 32

Maximum : 227

Median (quartile 2) : 109, divides the data into 2 equal halves

Quartile 1 divides the lower half of the data into 2 equal parts

$$\begin{aligned}\text{Quartile 1} &= \frac{78+90}{2} \\ &= 84\end{aligned}$$

Quartile 3 : this divides the upper half of the data into 2 equal parts

$$\begin{aligned}\text{Quartile 3} &= \frac{135+182}{2} \\ &= 158,5\end{aligned}$$

$$\begin{aligned}\text{Interquartile range} &= Q_3 - Q_1 \\ &= 158,5 - 84 \\ &= 74,5\end{aligned}$$

This can be summarised in the following table:

Month	Minimum	Q ₁	Q ₂	Q ₃	Maximum	IQR
November	21	65	77	134	200	69
December	32	84	109	158,5	227	74,5

The summary can be used to analyse which month had more fatalities by representing the data on box and whisker plots (in Section 7.5).



Activity 3: Measures of spread

The South African Weather Service recorded the temperatures for ten towns and cities in South Africa on 2009-05-13

TABLE 5: Temperatures recorded on 2009-05-13 for ten South African towns and cities

Temperature in °C	Bloemfontein (Bfn)	Cape Town (Ctn)	Durban (Dbn)	Johannesburg (Jhb)	Kimberley (Kmb)	Mafikeng (Mfk)	Musina (Msn)	Nelspruit (Nls)	Pretoria (Pta)	Polokwane (Pol.)
Minimum	5	13	15	6	10	8	20	9	7	3
Maximum	23	22	A	21	24	23	40	22	22	22

Mean (average) maximum temperature = 25,6°C

Use the information in the above table to answer the following questions.

1. The upper quartile for the minimum temperature is 13°C.
Identify the towns or cities in which the minimum temperatures were less than the upper quartile. (7)
2. Calculate:
 - 2.1 The maximum temperature, A for Durban. (2)
 - 2.2 The median of the maximum temperatures. (3)
 - 2.3 The percentage of the towns and cities that had a maximum temperature greater than the median. (1)
3. Would the maximum temperatures best be represented by the median or the mean?
Justify your answer. (3)
4. Determine the interquartile range for the maximum temperatures. (6)

[22]

95% of values lie below the 95th percentile and 5% of the values lie above.

Percentiles are used to determine the percentage of the data grouped in categories.

The concept of percentiles is used in growth charts. The curves on the growth chart below represent the percentile values of the data collected from different age groups. The growth chart is used to compare the BMI (body mass index) of a child to others in his age group. This is also used to determine the health status of the baby.

e.g. Worked example 9

A South African couple has relocated to USA .The growth chart below has been used to monitor the growth of their female children.

Use the chart to answer the questions.

CDC Growth Charts: United States

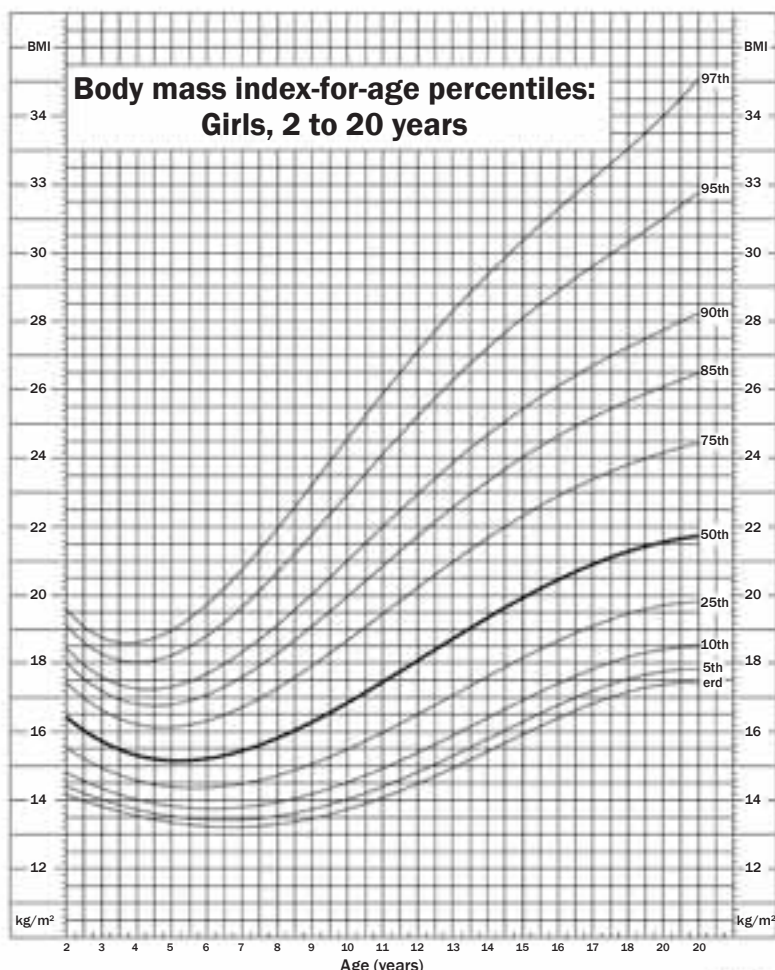

Published May 30, 2000.
 SOURCE: Developed by the National Center for Health Statistics in collaboration with the National Center for Chronic disease Prevention and Health Promotion (2000).



- a) What is the BMI of a 4 year old girl at the 95th percentile?

Solution

Draw a vertical line upwards from 4 years to the 95th percentile.

Draw a horizontal line across to find the relevant BMI.

The BMI is 18 kg/m².

- b) The couple's 10 year old child has a BMI of 16 kg/m². Between which percentile curves does her BMI lie?

Solution

Draw a vertical line upwards from 10 years.

Draw a horizontal line across from 16 kg/m².

Locate the percentile, where the two lines meet.

Between the 25th and 50th percentiles.

- c) The BMI of their youngest child who is 2 years old lies at the 45th percentile. What does this mean?

Solution

The BMI of 45% of the girls of her age group is less than hers and the BMI of 55% of the girls in her age group is above hers.

- d) Use the table below to determine the health status of their 16 year old girl with the BMI of 20 kg/m²

BMI for age percentile range	Weight status
< 5 th percentile	Underweight
5 th percentile to < 85 th percentile	Healthy
85 th percentile to < 95 th percentile	Risk of overweight
≥ 95 th percentile	Overweight

Solution

Draw a vertical line upwards from 16 years.

Draw the horizontal line across from 20 kg/m².

Determine the percentile and use it to determine the health status: it is just below the 50th percentile, therefore the child is healthy.



Activity 4: Working with a percentile graph

Study the growth chart below and answer questions that follow.

Average Growth Patterns of Breastfed Infants

The red points plotted on the CDC Growth Charts represent the average weight-for-age for a small set of infant boys and girls who were breastfed for at least 12 months (see references).

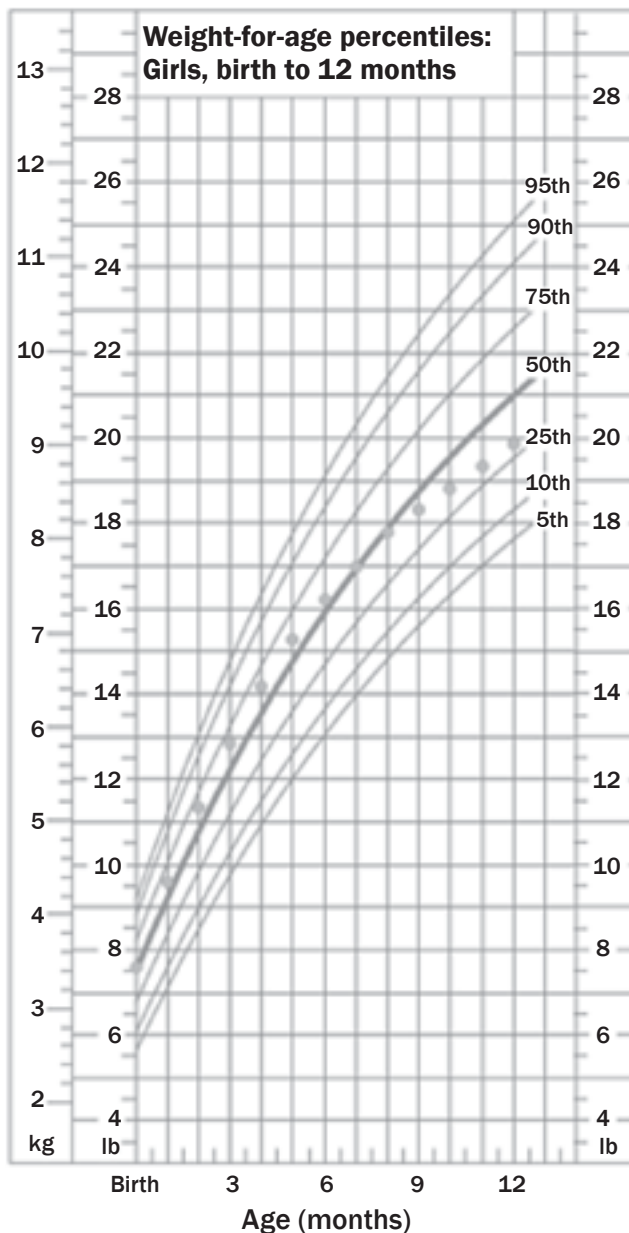
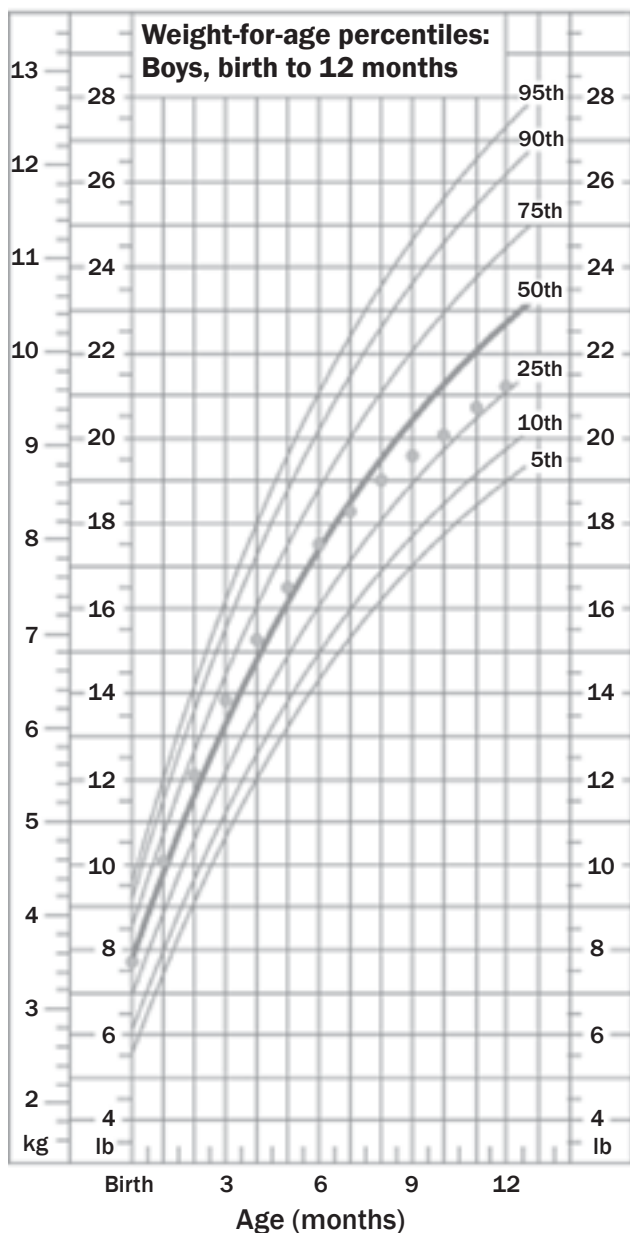

Sources:

- Base chart – CDC Growth Charts: United States, Published May 30, 2000.

Graphic by kellymom.com, 2004

- Breastfed baby data points – WHO Working Group on Infant Growth. An Evaluation of Infant Growth: a summary of analyses performed in preparation for the WHO Expert Committee on Physical Status: the use and interpretation of anthropometry. (WHO/NUT/94.8). Geneva World Health Organization. 1994, p21.

Mrs Michael, the visiting American ambassador has brought her twins, a boy and a girl who are 9 months old. She is also looking after her late sister's daughter who is 1 year old. Use the table below.

BMI for age percentile range	Weight status
<5 th percentile	Underweight
5 th percentile to < 85 th percentile	Healthy
85 th percentile to < 95 th percentile	Risk of overweight
≥ 95 th percentile	Overweight

1. What is the weight of her daughter at the 75th percentile? (1)
 2. Give a range of percentile curves for her son who weighs 10,5 kg. (1)
 3. Calculate the BMI of her niece whose height is 60 cm and whose weight at the 25th percentile. Give your answer in kg/m².
Use the formula : $BMI = \frac{\text{mass}}{\text{height}^2}$. (3)
 4. Do you think she must be worried about her niece's health status? Explain. (1)
 5. What does it mean if the weight of a child is at the 68th percentile? (2)
- [8]**

Solutions

1. 9 kg ✓ (1)
2. 90th to 75th percentile ✓ (1)
3. Her weight is 9 kg ✓
60 cm = 0,6 m
 $BMI = \frac{\text{mass}}{\text{height}^2}$ ✓
= $9 \div 0,6^2$
= 25 kg/m² ✓ (3)
4. No, because she is healthy according to the BMI table. ✓ (1)
5. The weight of 68% of the children of her age group is less than hers, and the weight of 32% of the children in her age group is above hers. ✓✓ (2)

[8]

6.5 Representing, interpreting and analysing data

Purposes of graphs:

- a way of exploring the relationships in data
- a way of displaying and reporting data
- making it easier to report patterns and relationships, shapes of distributions and trends.

Any graph used to report findings should show:

- the significant features and findings of the investigation in a fair and easy-to-read way
- the underlying structure of an investigation in terms of the relationships between and within the variables
- the dependent variable on the horizontal (x) axis and the independent variable on the vertical (y) axis.

Types of graphs

We have the following types of graphs:

- Line graph
- Bar graph
- Histogram
- Scatter plot
- Pie chart
- Box and whisker plot.

6.5.1 Line graphs

In data handling we use line graphs to show the relationship between two quantities. A line graph is formed by using straight lines to join data points which have been mapped on a grid. It is used to show the change of information over time.



Worked example 10

The table below shows the average number of minutes per month that Jabu spent watching TV from January to November last year.

Month	Jan	Feb	Mar	Apr	May	Jun	Jul	Aug	Sep	Oct	Nov
Daily TV viewing time (min)	108	103	108	120	115	122	116	105	110	105	104

- Plot this data on a set of axes.
- Can you observe any trends or patterns in the data? Give some possible reasons for these trends.
- Would you be able to represent this data on a bar graph?
- What is the advantage of using a line graph to show this information?

Solution for example 1

a) The points are plotted and connected with line segments.

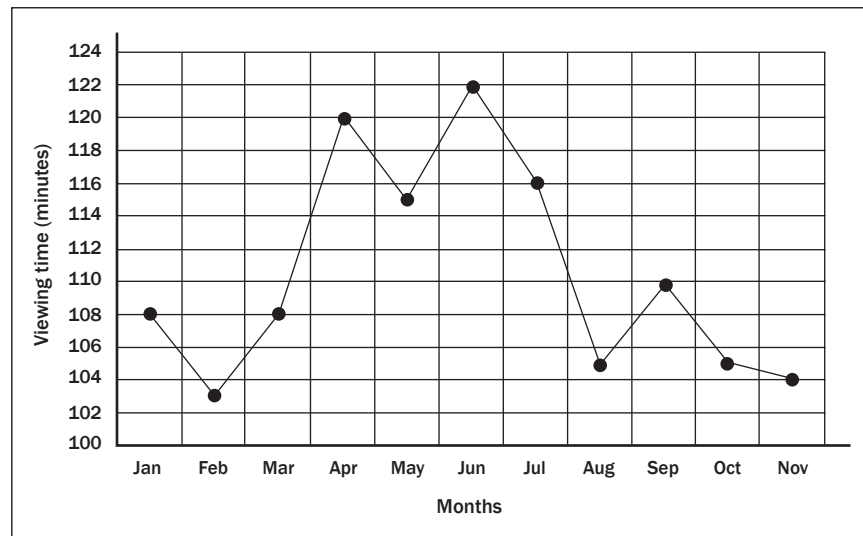

b) You can see that Jabu's viewing time increases in April, again in June and slightly in September (perhaps due to school holidays). We also see decreases in his viewing time during February, May, August, October and November. These could be times when he was preparing for tests and exams.

c) Yes, it would be possible to represent this data on a bar graph; the number of minutes would be plotted as a bar for each month.

d) A line graph helps us to see trends because we can easily see the increasing or decreasing slope of each line segment in the graph.

6.5.2 Bar graphs

A bar graph is used to represent data that is sorted into categories. Display data is compared in categories. Each bar shows the number of items in that category and there are spaces between the bars.



Take note that the bar graphs may be horizontal or vertical.

A bar graph can be a:

- single graph
- double or multiple graph
- compound or stacked graph.



Worked example 11

The school tuck shop keeps track of how many hot dogs, sandwiches, salads and burgers they sell at one break time. They have the data given in the table below. Draw a bar graph to represent this data.

Item	Frequency
Hot dogs	15
Sandwiches	35
Salads	10
Burgers	12

Solution for example 2

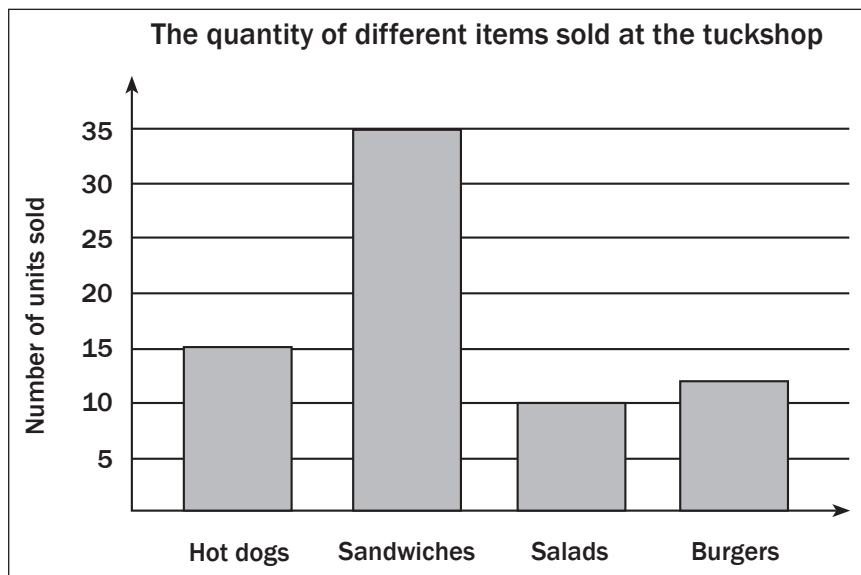

Worked example 12

A survey of 1 000 households was undertaken during 2001 to determine how many households used various electronic appliances. A survey of the same number of households was repeated during 2007.

The graph below shows the results of the two surveys.

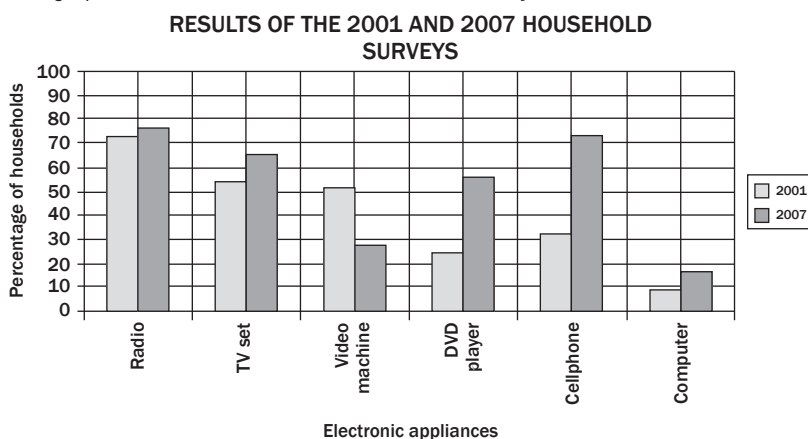

TABLE 2: Percentage of households using the various electronic appliances

Year	Radio	TV set	Video machine	DVD player	Cellphone	Computer
2001	73,0	53,8	51,2	24,4	32,3	8,8
2007	76,6	65,6	27,6	56,5	72,9	15,7

- What was the percentage increase in usage of TV sets between 2001 and 2007?
- Which appliance was used most in households during both 2001 and 2007?
- Which appliance showed a decreased usage in 2007 compared to 2001?

- d. How many of the 1 000 households surveyed used cellphones during 2007?
 e. Calculate the difference in percentage usage during 2001 between TV sets and DVD players.

Solution for example 3

- a. $65,6\% - 53,8\% = 11,8\%$
 b. Radio
 c. Video machine
 d. $72,9\% \times 1\ 000$ households
 $= 0,729 \times 1\ 000$
 $= 729$ households
 e. Difference in percentage = $53,8\% - 24,4\%$
 $= 29,4\%$



Activity 5: Working with bar graphs

The compound bar graph below shows the percentage of South African children for age seven to thirteen enrolled in primary schools during 1996 and 2007.

PERCENTAGE ENROLMENT OF SOUTH AFRICAN CHILDREN IN PRIMARY SCHOOL

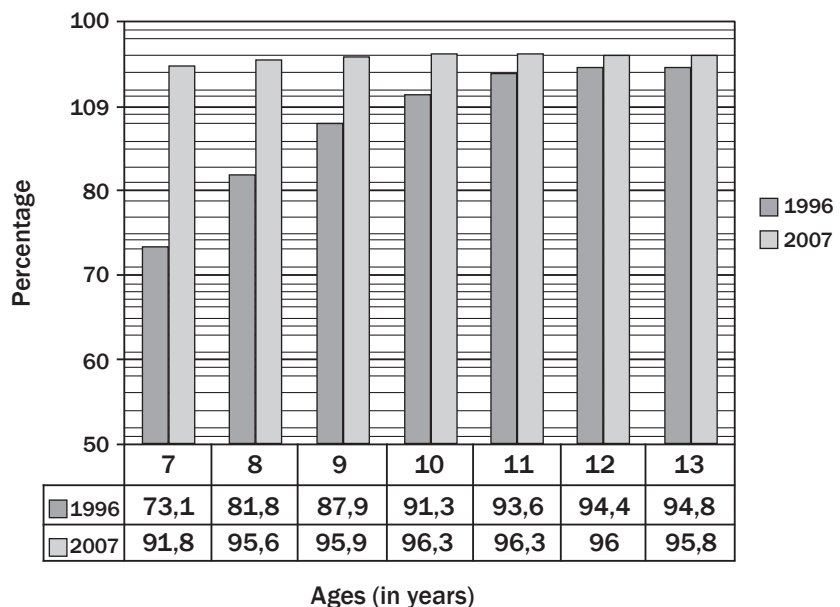

[Source: www.businessreport.co.za. 8 November 2007]

Use the graph above to answer the following questions.

- a. What percentage of 10 year olds was enrolled during 1996? (1)
- b. Calculate the increase in the percentage enrolment of 11 year olds from 1996 to 2007. (1)
- c. Which age group had
1. the largest percentage enrolment in 1996? (1)
 2. the smallest percentage enrolment in 2007? (1)
 3. the greatest increase in percentage enrolment between 1996 and 2007? (1)
- d. If there were 240 000 ten year old children in South Africa in 1996, calculate the number of 10 year olds enrolled in primary schools in 1996. (2)
- [7]

Solutions

- a. 91,3% ✓ (1)
- b. Increase = 96,3% - 93,6% ✓
= 2,7% (1)
- c. 1. 13 year olds ✓ (1)
2. 7 year olds ✓ (1)
3. 7 year olds ✓ (1)
- d. 91,3% of 240 000
 $91,3 \div 100 \times 240\ 000$ ✓
= 219 120 ✓ (2)
- [7]

6.5.3 Histograms

Histograms are different from bar graphs in that they represent continuous data. Data that is displayed on a histogram is also grouped. There are no spaces between the bars.



Worked example 13

Lwanda measures the lengths of his school books (in cm) and draws up the frequency table below. Draw a histogram to represent this data.

Length of book	Frequency
20 - 23,9 cm	4
24 - 26,9 cm	7
27 - 29,9 cm	5
Longer than 30 cm	3

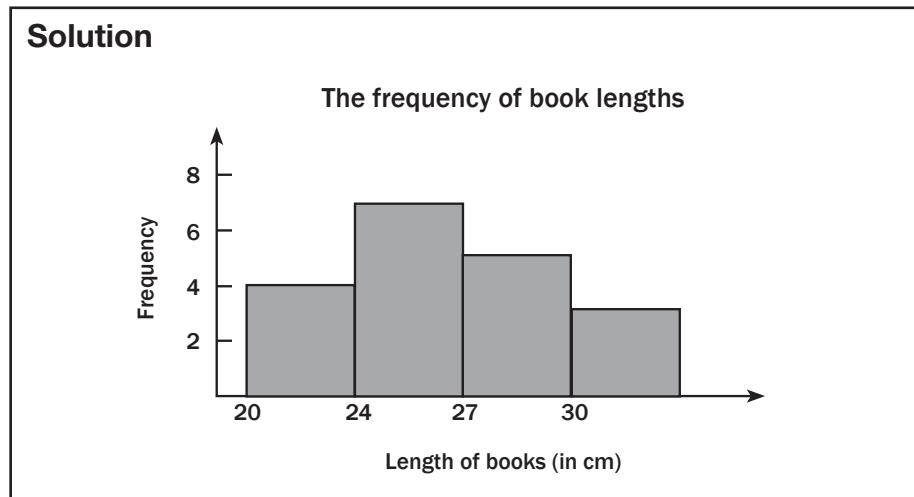
Solution**Activity 6: Working with histograms**

Mr Smith, an investor from Australia, has just opened the branch of Raetsiza Company in Pretoria central. The graph below represents the salary categories of the employees versus the number of employees per category. Study the graph and answer questions that follow.

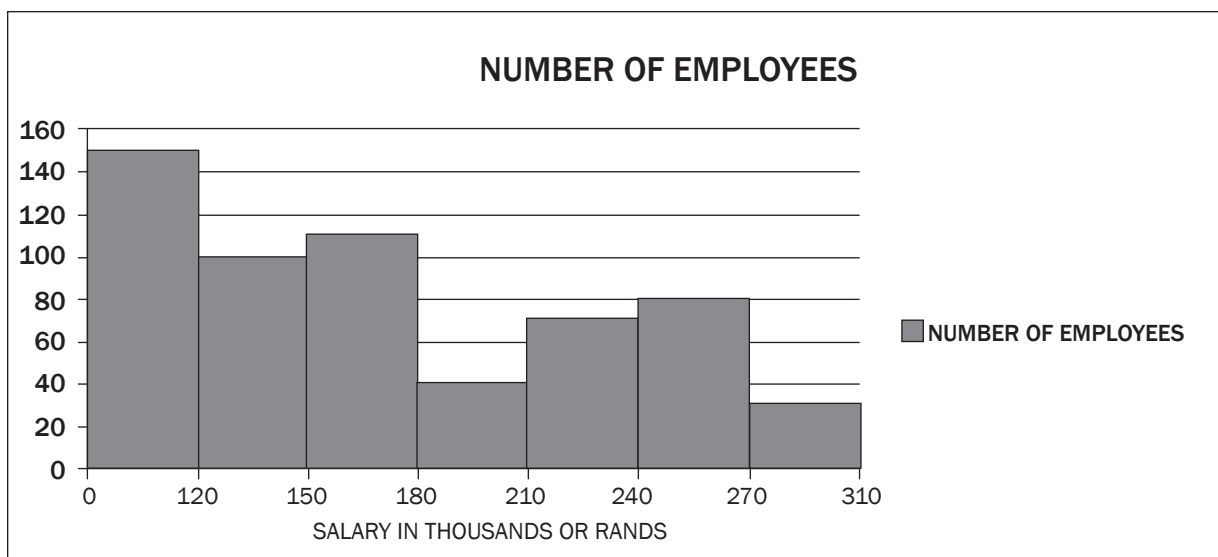

- How many people were employed by the Raetsiza Company? (2)
- How many employees are earning the lowest salary? (1)
- Why do fewer employees earn the highest salary? (1)
- Give possible reasons why there are fewer employees in the category of R180 000 to R210 000. (1)
- If the salary increases by 6%, what will be the new maximum amount for employees in the category R150 000 – R180 000? (2)

[7]

Solutions

1. $150 + 100 + 110 + 40 + 70 + 80 \checkmark + 30 = 580 \checkmark$ (2)
 2. 150 earn less than R120 000 \checkmark (1)
 3. They are senior employees. \checkmark (1)
 4. They have got special skills. \checkmark (1)
 5. 106% of R180
 $= 1,06 \times R180\ 000 \checkmark$
 $= R190\ 800 \checkmark$ (2)
- [7]

6.5.4 Pie charts

Pie charts are circular graphs, divided into sectors. They are used to show the parts that make up a whole. They can be useful for comparing the size of relative parts. They do not give quantities of the categories, only the relative (compared) amounts. They do not show the actual amounts. The information is often presented as percentages that must add up to 100%. They are often used in media to show clear and important differences, but they cannot show shape and spread of data.



Learners are not expected to draw pie charts.



Worked example 14

The pie chart below shows a survey of the different types of the favourite fruit juice flavours that are normally bought by a group of 120 learners from Ndukwenhle High school during their lunch time.

Fruit Juice Flavours

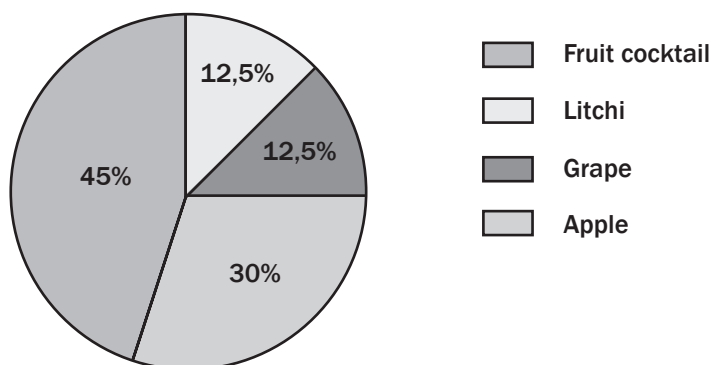

- a) Calculate how many learners chose each type of juice.
- b) In what way does the pie chart work better than a bar graph to represent this data?
- c) What information would a bar graph give you that this pie chart does not?

Solutions

- a) 45% of 120 learners
= 54 learners who chose fruit cocktail.
- 30% of 120
= 36 learners who chose apple.
- 12,5% of 120 learners
= 15 learners who chose grape.
- 12,5% of 120
= 15 learners who chose litchi.
- b) The pie chart is a simple, visual representation that works well for representing percentages. A pie chart allows us to see at a glance the relative proportions of the learners who prefer each flavour.
- c) The number of learners who prefer each flavour.

**Activity 7: Working with pie charts**

A recent survey looked at households in two income groups. The study determined what percentage of monthly income was spent on food, housing and other requirements. The pie charts below represent the findings of the study.

Spending by a household in Group 1
Average monthly income:
R3 000 per month

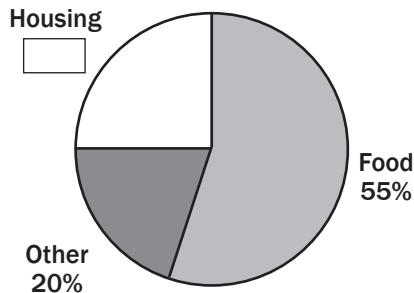

Spending by a household in Group 2
Average monthly income:
R20 000 per month

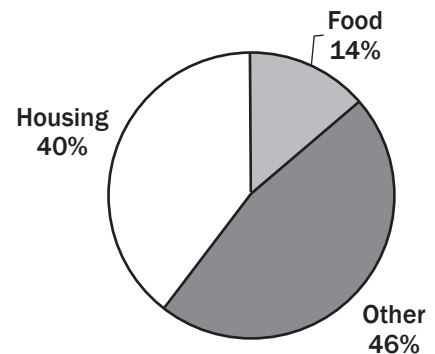

- What were the average monthly incomes of the groups considered? (2)
- What percentage of Group 1's earnings was spent on housing? (1)
- How much was spent on housing by a household in Group 2? (2)
- Which group spent the larger amount of money on food? Justify your answer by calculations. (5)

[10]

Solutions

- a. R3 000 and R20 000 ✓✓ (2)
- b. $100\% - 75\% = 25\%$ ✓ (1)
- c. $(40 \div 100) \times 20\ 000$ ✓ (2)
= R8 000 ✓
- d. 1. $(55 \div 100) \times 3\ 000$ ✓
= R1 650 ✓
2. $(14 \div 100) \times 20\ 000$ ✓
= R2 800 (2 spent more) ✓✓ (5)

[10]

6.5.5 Scatter plot

A scatter plot is the most useful graph for studying the relationship (correlation) between two variables. It shows one of the variables on the horizontal axis and the other variable on the vertical axis. The resulting scatter plot of points will show at a glance whether a relationship exists. You cannot have more than two sets of data on a scatter plot.

A scatter plot can show:

- positive correlation
 - negative correlation
 - no correlation.
- When seeing patterns remember that the tighter together the points are clustered, the stronger the correlation between the variables you have plotted.
 - If you find a pattern that slopes from the lower left to the upper right, this tells you that as x increases, y also increases. This means there is a “positive” correlation between the two variables.
 - If you find a pattern that slopes from the upper left to the lower right, this tells you that as x increases, y decreases. This means there is a “negative” correlation between the two variables.

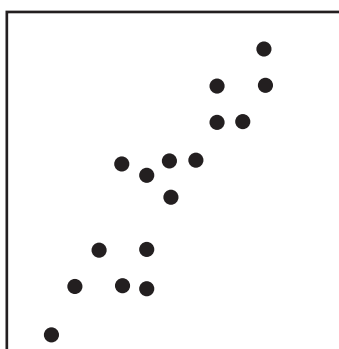

positive correlation

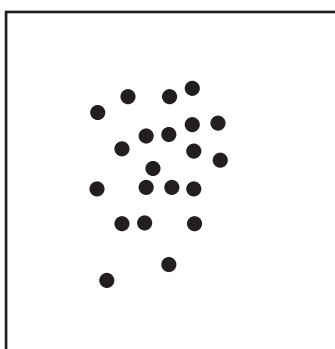

no correlation

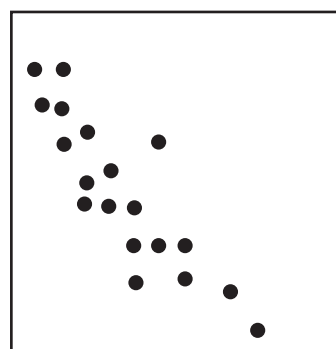

negative correlation



Learners are not expected to draw a line of best fit.



Worked example 15

After writing controlled tests for term one, Tourism and Mathematical Literacy marks of 10 randomly selected Grade 10 learners were recorded.

TOURISM	55	60	20	70	5	40	50	10	30	55
MATHS LIT	70	60	40	75	80	30	70	5	45	50

- Draw a scatter plot for the marks.
- Describe the relationship between the marks.
- Is there any point you regard as an outlier? Give a reason for your answer.
- Is there a correlation between the sets of data?

Solutions

SCATTER PLOT

a)

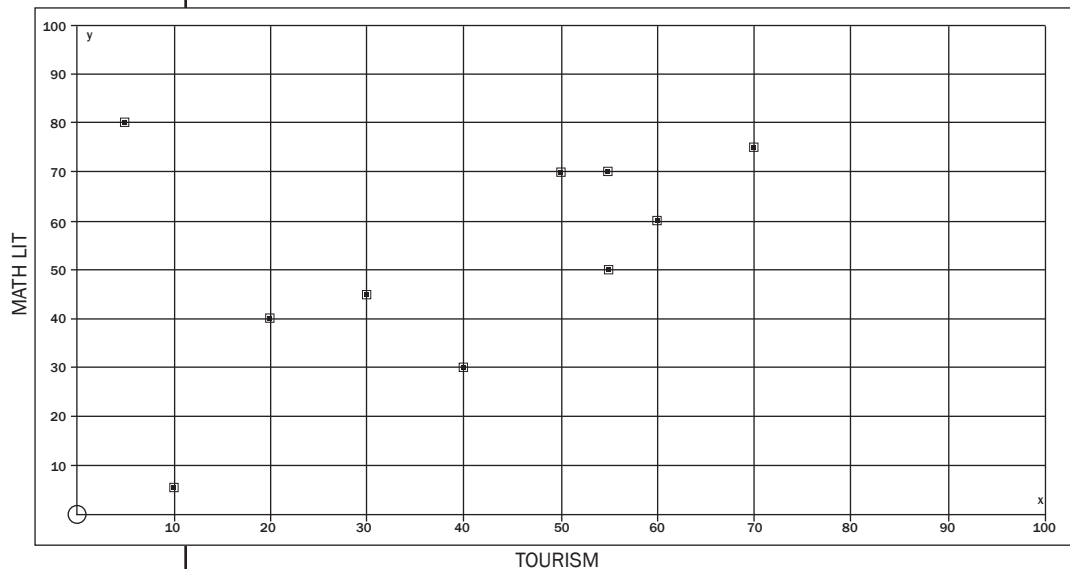

- There is a positive relationship between the Tourism and Mathematical Literacy marks.
- Yes, point (5; 80). The learner has got the highest mark in Mathematical Literacy and the lowest mark in Tourism. Perhaps there is a mistake with one of the marks.
- Yes and it is a positive correlation.

6.5.6 Box and whisker plots

Box and whisker plots are graphical representation of the five number summary of a set of data.

The five number summary:

Minimum value

Lower quartile (Q_1)

Median (Q_2)

Third quartile (Q_3)

Maximum value



Learners are not expected to draw the box and whisker plot.



Worked example 16

Read from the box and whisker plot the values of the five number summary.

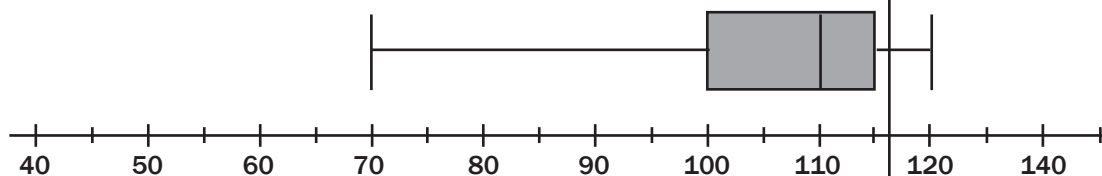

Solution

Minimum	70
Lower quartile (Q_1)	100
Median (Q_2)	110
Third quartile (Q_3)	115
Maximum value	120



Activity 8: Box and whisker plots

(Sunday times 2009 Q & A)

The box and whisker plot below represents the batting averages of 160 cricketers who have batted in T20 matches since 1 January 2009. Answer the questions that are based on the plot.

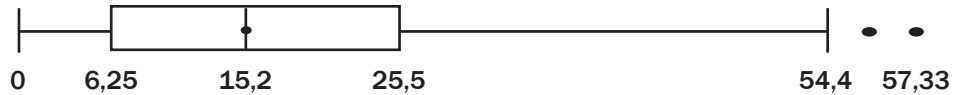

1. What is the name given to the two data points with values 57 and 57,33? (1)
 2. How many players have a batting average less than 6,25? (2)
 3. What must a batsman's average be for him to be in the top quartile? (1)
 - d. Jacques Kallis is the South African with the highest batting average. If his average is 48,4, how does he compare with the other batsman? (1)
- [5]**

Solution

1. Outliers ✓ (1)
2. About 40 players (lower quartile of 160 players) ✓✓ (2)
3. $>25,5$ ✓ (1)
4. He is definitely in the top quartile. ✓ He is close to the highest batting averages so he compares favourably with the best batsmen in the world. (1)

[5]

6.6 Misleading data

(Used http://en.wikipedia.org/wiki/Misleading_graph as a source for graphics – Creative Commons)

Graphs in the media are often drawn to support a particular point of view. We need to be aware that in some situations the graph may give a false impression of the data.

There are numerous ways in which a misleading graph may be constructed.

Biased labelling

The use of biased words in the graph's title, axis labels, or caption may lead the reader to an incorrect conclusion.

Misleading graphs

Comparing pie charts of different sizes could be misleading as people cannot accurately read the comparative area of circles.

Thin slices which are hard to read may be difficult to interpret.

Making a pie chart 3D or drawing at an angle might make interpretation difficult due to the resulting effect.

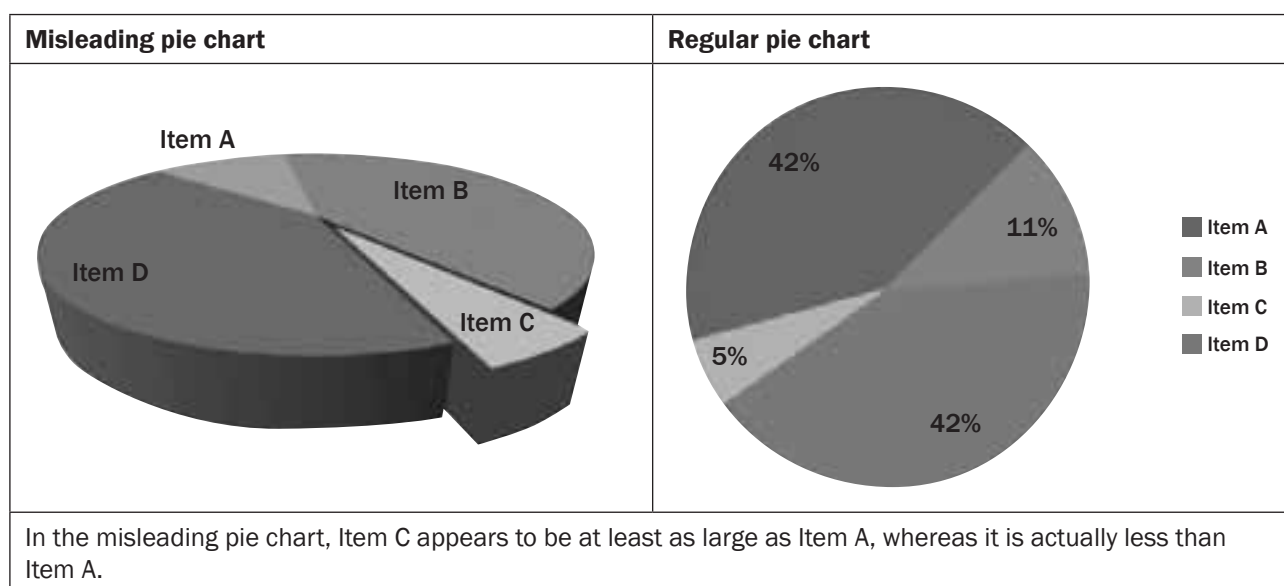

Source: BBC – GCSE: Bitesize misleading graphs

e.g. Worked example 17

The histogram below shows the price increase of houses from 1998 to 1999.

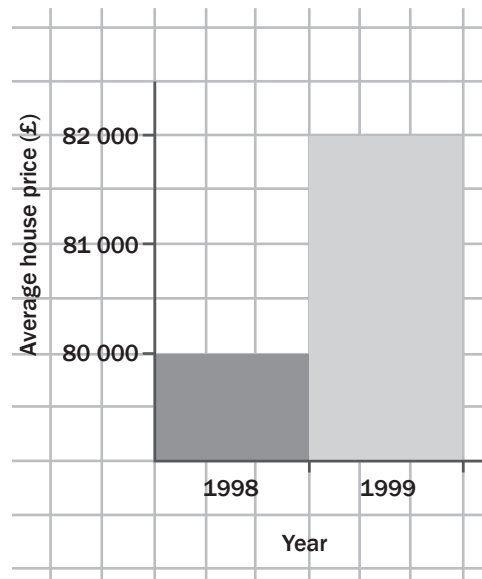

What is misleading about the histogram shown above and how should the information be represented?

Solution

It looks as though house prices have tripled (increased by a factor of 3) in one year, but this is not true. The graph is misleading because the vertical axis does not start at 0.

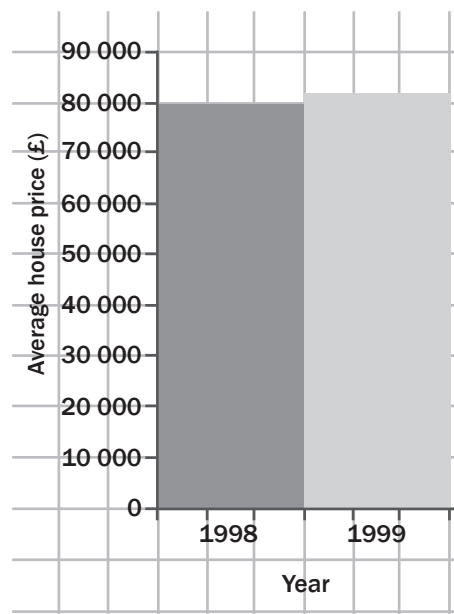



Worked example 18: Misleading graphs

What can you conclude from the graph given here? How best can this information be presented?

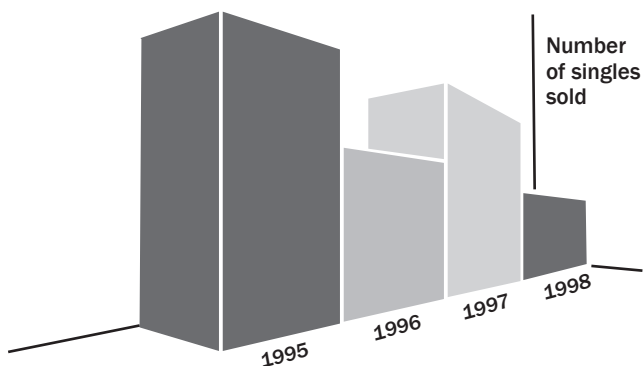

Axis changes

Changing y-axis maximum

Original graph	Smaller maximum	Larger maximum

Changing the y-axis maximum affects how the graph appears. A higher maximum will cause the graph to appear to have less-volatility, less-growth and a less steep line than a lower maximum.

No scale

The scales of a graph are often used to exaggerate or minimise differences.

Misleading bar graph with no scale

Less difference	More difference

Note the lack of a starting value for the y-axis, which makes it unclear if the graph is truncated. Additionally, note the lack of tick marks which prevents the reader from determining if the graph bars are properly scaled. Without a scale, the visual difference between the bars can be easily manipulated.

Solution

It looks from the graph as if the number of singles sold went down from 1995 to 1996 and up from 1996 to 1997 and then down again. The information could be clearer if the 2D bars were used.

Now it is clear that sales for the year 1995 and 1997 are the same.

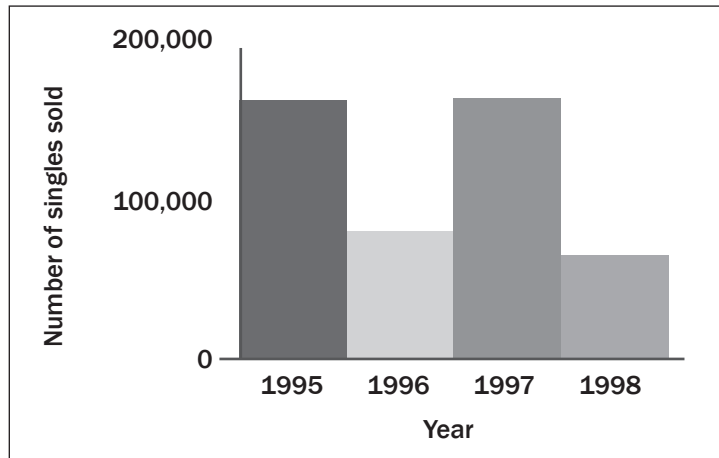



Activity 9: Revision exercise

Misleading graphs

1. Look at the bar graph below and answer the questions that follow.

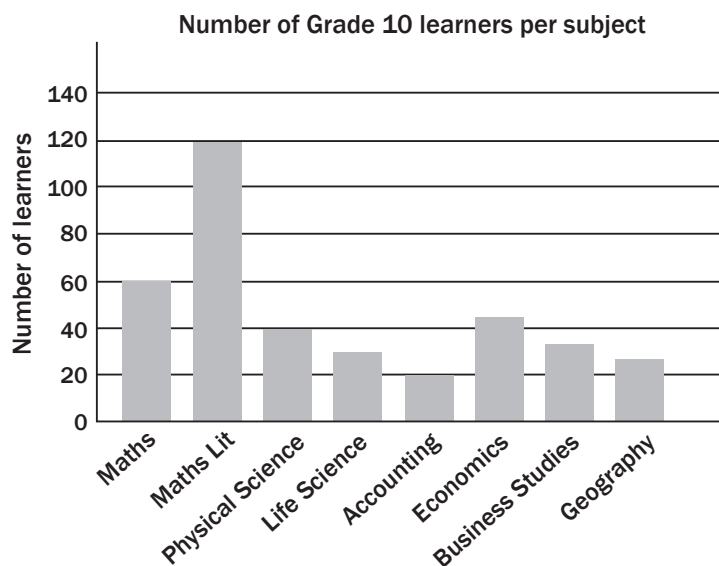

- Does this graph tell us how many Grade 10 learners there are in total? (3)
 - Can we assume that none of the learners who take Accounting take Geography? (2)
 - A pie graph of this data would not make sense. Explain why. (3)
- [8]**

Solutions to 1

- No. It may look like there are 140 learners in total ✓ but learners take more than one subject, ✓ so we can't use the numbers of learners per subject to determine how many learners there are altogether. ✓ (3)
- No, we have no information ✓ about whether learners can take both Accounting and Geography. ✓ (2)
- Learners do not only take one subject, ✓ therefore the data cannot be split into discrete percentages ✓ per subject and represented using a pie chart. ✓ (3)

[8]

2. The two graphs below show the same data in different forms about the members of Uthando Saving Club from 2004 to 2007. Using the graphs, explain whether each of the statements beneath is true or false.

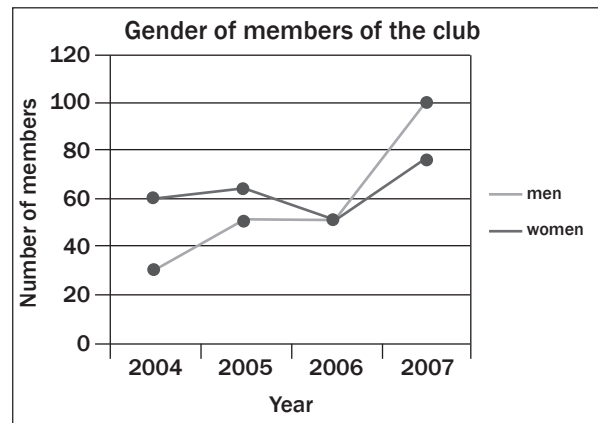
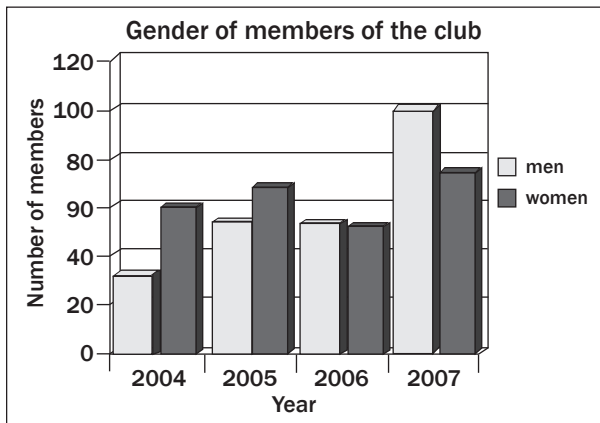

- a) The number of female members was greater than the number of male members each year. (1)
- b) In 2006 the numbers of male and female members were equal. (2)
- c) The number of members who are men has gradually increased over the years. (2)
- d) There were more female members in 2007 than there were in 2005. (1)
- e) There were more male members in 2006 than there were in 2005. (1)
- f) The comparison of male and female members has changed over the years. (1)
- [8]**

Solutions to 2

- a) FALSE – In 2007 there were fewer female members. ✓ (1)
- b) TRUE – In 2006 the bars for men and women are the same height on the bar chart; ✓ on the line graph the lines showing 'men' and 'women' cross. ✓ (2)
- c) TRUE – In 2005 and 2006 the number is the same, but over ✓ the four-year period overall, it gradually increases. ✓ (2)
- d) TRUE – The line showing the 'women' is higher in 2007 than the same line in 2005. ✓ (1)
- e) FALSE – There is the same number of men in 2005 and 2006. ✓ (1)
- f) TRUE – In 2005 there were more women than men; by 2007 there are more men than women. ✓ (1)

[8]

3. Marvin has a gym. In 2012 a total of 1 150 people attended the weight-lifting classes. He kept a record of the number of males, females and different races attended the weight-lifting class from 1 January to 31 December 2012.

TABLE: Number of males and females attending the weight-lifting classes

Month	Number of males	Number of females
January	60	16
February	71	19
March	63	18
April	82	15
May	80	19
June	52	13
July	96	A
August	79	14
September	80	15
October	119	20
November	76	25
December	85	18
TOTAL	943	

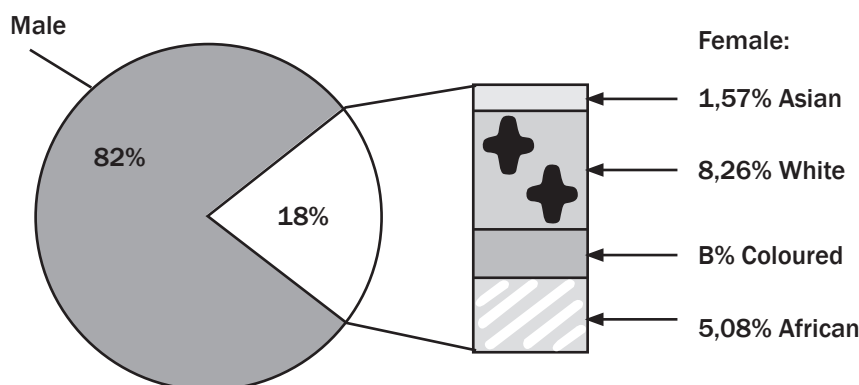

3. Use the pie chart and the table above to answer the following questions.
- Give the ratio (in simplest form) of the number of females to males who attended the weight-lifting classes in September 2012. (2)
 - Calculate the missing values A and B. (5)
 - If a weight lifter is chosen at random from the whole year's weight-lifting class, what is the probability that the weight lifter will be a white female? (5)
 - Determine the:
 - mean (average) of the number of males in the weight-lifting class (2)
 - modal monthly number of females in the weight-lifting class (1)
 - median of the number of males in the weight-lifting class (3)
 - range of the number of females in the weight-lifting class. (2)

[20]

Solutions to 3

a) $15:80$ ✓
 $= 3:16$ ✓ (2)

b) $A = 1\,150 - (943 + 16 + 19 + 18 + 15 + 19 + 13 + 14 + 15 + 20 + 25 + 18)$ ✓
 $= 1\,150 - 1\,135$
 $= 15$ ✓
 $B = 18\% - (1,57\% + 8,26\% + 5,08\%)$ ✓
 $= 3,09\%$ ✓ (5)

c) Number of females $= 1\,150 - 943$
 $= 207$ ✓
 Number of white females $= 8,26\%$ of 207 ✓
 $= 17,0982$
 ≈ 17 ✓
 $P(\text{white female}) = \frac{17}{1\,150}$ ✓
 $= 0,01478$ ✓ (5)

d) (i) Mean $= 943 \div 12$ ✓
 $= 78,58$
 ≈ 79 ✓ (2)

(ii) Mode $= 15$ ✓ (1)

(iii) $52;60;63;71;76;79;80;80;82;85;96;119$ ✓
 Median $= \frac{79+80}{2}$ ✓
 $= 79,5$
 ≈ 80 ✓ (3)

(iv) Range $= 25 - 13$ ✓
 $= 12$ ✓ (2)

[20]

Probability

Many things in life can't be predicted with certainty. The best we can say is how likely they are to happen, using the idea of probability.

Probability helps us to interpret information in many real-life situations, such as:

- drug and pregnancy tests
- risk analysis in business
- working out all the possible combinations of items
- games of chance, such as cards, dice and gambling
- weather forecasts
- risks of veld fires and lightning
- advertising.

In all of the above situations, people use probability to decide how likely it is that something will happen.



7.1 The probability scale

A probability can be described as a fraction, a decimal or a percentage. The probability of any event is given a number between 0 (impossible) and 1 (certain).

In words:	Impossible	Even chances	Certain
As decimal fractions:	0	0,5	1,0
As fractions	0	$\frac{1}{2}$	1
As percentages	0%	50%	100%

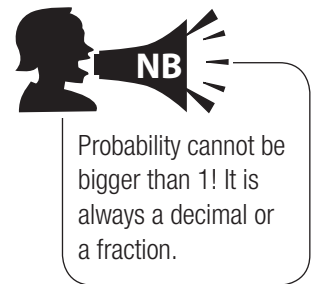

The purpose of this scale is to show that there is a continuous range of probabilities. The words are rough descriptions. The numbers give more exact descriptions.

Revise the work on decimals, fractions and percentages in Chapter 1. Remember how to convert between them. Memorise the important ones, for example:

$$\frac{3}{4} = 0,75 = 75\%. \text{ These are all numbers less than 1.}$$

An event has a 50% chance of happening if it is equally likely to happen as not to happen. Tossing a coin is an example: you have a 50% chance of getting heads and a 50% chance of getting tails.

Most things are not as fair as this, though. If you have five T-shirts, three blue and two red, and you take a T-shirt without looking, you have a $\frac{3}{5}$ chance of taking a blue one.

7.2 Games of chance



We base our prediction on what we know about coins.



The important thing to note is that the more times you throw the coin, the closer the relative frequency of heads will get to 50%.

So when the weather report says there is a 60% chance of rain, this is the theoretical probability of rain?



Yes, the weather each day is one trial. If you look at lots of days with similar weather patterns, the number of rainy days will be close to 60%.

When a coin is tossed, there are two possible outcomes:

- heads (H) or
- tails (T).

We can predict that the probability of the coin landing on H is $\frac{1}{2}$ or 0,5, and the probability of the coin landing on T is $\frac{1}{2}$.

When a die (or dice) is tossed, there are 6 possible outcomes. Each number (1; 2; 3; 4; 5; 6) has a probability of $\frac{1}{6}$ of coming up.

These games of chance help us to understand probability better. These games work with random events, so they are a useful way to learn how to use probabilities to predict events.

Words you need to know

- **Frequency:** The number of times that something happens.
- **Random:** When something happens without being made to happen on purpose.
- **Trial:** A test. Throwing a dice and tossing a coin are examples of a trial.
- **Fair:** Treated equally, without having an advantage or disadvantage.
- **Theoretical probability:** The calculated probability, not the actual result.

The chance of getting T on a coin or 2 on a dice is called the *theoretical probability*.

When you do a probability experiment, such as tossing a coin a number of times, you are finding the relative frequency of each outcome. For example, if you toss a coin 10 times and you get heads 3 times, then the relative frequency is simply 3 in 10 or $\frac{3}{10}$.

What is the chance of throwing an even number on a dice, if you throw the dice once?

This means getting any of the even numbers on the dice. List the correct outcomes: 2; 4; 6.

There are three even outcomes out of six possible outcomes. So the chance is now 50% (which is the same as 0,5 or $\frac{1}{2}$). It is a much bigger chance than throwing only one of the numbers.

A 'yes' outcome and a 'no' outcome

If we are looking for a particular outcome, such as getting a 4 on a dice, the chances of not getting that outcome can also be worked out.

The probability of getting a 4 is $\frac{1}{6}$, so the probability of not getting a 4 is $\frac{5}{6}$.

e.g. Worked example 1

Write down the chances of getting the outcomes in the following situations. Write your answers as decimals, percentages and common fractions.



You must give all three.

- Getting any odd number when throwing a dice once.
- Getting a 3 when throwing a dice with 8 faces.
- The arrow of this spinner lands on a colour randomly when you spin it. What are the chances of landing on red?
- You take out a T-shirt (without looking!) from a pile which has 1 blue, 3 green and 2 purple T-shirts in it. What are the chances of taking out a purple T-shirt?

Solutions

- The odd numbers on a dice are 1; 3; 5. So there are 3 numbers. There are six numbers in total, so the chances are $\frac{3}{6} = 0,5 = 50\%$.
- The 3 is only one number out of a total of 8 possible numbers. So the probability is $\frac{1}{8} = 0,125 = 12,5\%$.
- Two of the parts are red. There are five parts in total. So the probability is $\frac{2}{5} = 0,4 = 40\%$.
- There are 2 purple T-shirts. There are 6 T-shirts in total. This means the probability of taking out a purple one is $\frac{2}{6} = \frac{1}{3} = 0,33\dots = 33\frac{1}{3}\%$.

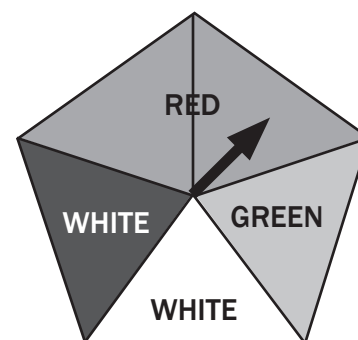

Fair and unfair games

Do you think games of chance are always fair?

- Some games are designed to be unfair. Do gamblers have a good chance of winning? Are you more likely to win if you are luckier?
- Games in a casino are designed so that the player has a small chance of winning. Every now and then, the player wins, which gives them confidence to carry on playing! However, if the game is weighted towards one player (usually the owner of the casino!), then that person will win much more often than they lose.
- When you know the chance of a particular event, then you can make predictions about the probability of it happening. A fair game is a game in which there is an equal chance of winning or losing. We can say that if a game is fair then the probability of winning is equal to the probability of losing.
- If you change the rules, you can make the game less fair. For example, if someone wins a game of dice only if they get a 3, is it a fair game?



There is no such thing as luck! The chances remain the same.

I can see why it helps to memorise the common fractions, decimals and percentages conversions. It saves a lot of time and mistakes! I can always work them out, if I can't remember.





Don't get confused between the number 20 that she is aiming for, and the number of numbers on the wheel.

The 20 is just one of the numbers.

e.g. Worked example 2

- a) A gambler bets her money on getting the number 20 on a roulette wheel in a casino. There are 36 numbers on the wheel. If she loses, the casino takes her money.

What are her chances of losing the bet? Write your answer as a percentage, rounded off to one decimal place.

- b) She has noticed that 20 has come up often in the previous spins of the wheel. Explain to her why this does not mean that 20 is more likely to come up now.

Solutions

- a) Losing the bet means not getting a 20. The number 20 is one number out of 36.

So the percentage of losing her bet is 35 out of 36 = $\frac{35}{36} \times 100\% = 97,2\%$.

- b) The probability of not getting a 20 is always 97,2%. It is random, and the fact that she has seen a few 20s has no effect on future events.

7.3 Using tree diagrams

A tree diagram is a useful way to show all possible outcomes.

If we flip a coin there are two possible outcomes. There is a probability of $\frac{1}{2}$ of getting Heads and a probability of $\frac{1}{2}$ of getting Tails.

The branches of a tree diagram show these probabilities.

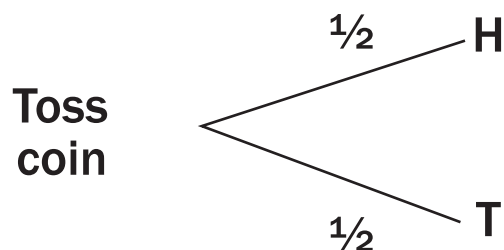

If we roll a dice the tree diagram would look like this.

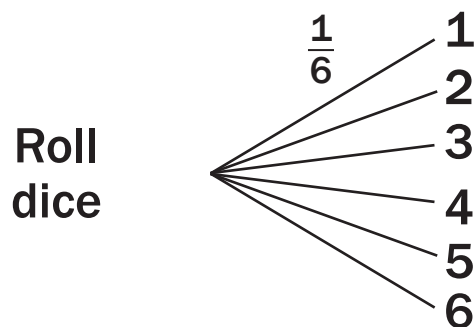

There is a $\frac{1}{6}$ chance of getting each number.

Let's take these two situations mentioned above and combine their outcomes. We are going to flip the coin once and throw the dice once. We now have a combined event.

Let's look at how a tree diagram is used to show combined outcomes.



Worked example 3

The tree diagram below shows all the possible outcomes for tossing a coin and then throwing a dice.

Coin	Dice	Outcomes	Probability
Heads	1	H1	$\frac{1}{12}$
	2	H2	$\frac{1}{12}$
	3	H3	$\frac{1}{12}$
	4	H4	$\frac{1}{12}$
	5	H5	$\frac{1}{12}$
	6	H6	$\frac{1}{12}$
Tails	1	T1	$\frac{1}{12}$
	2	T2	$\frac{1}{12}$
	3	T3	$\frac{1}{12}$
	4	T4	$\frac{1}{12}$
	5	T5	$\frac{1}{12}$
	6	T6	$\frac{1}{12}$

- How many possible outcomes are there? List them.
- What is the probability of getting each outcome? Write this probability as a fraction, a decimal (rounded off to 2 decimal numbers) and a percentage.
- How many of the 12 possible outcomes include getting an even number on the dice?
- How many of the 12 possible outcomes include getting Tails and an even number?
- How many of the 12 possible outcomes include getting a 5 on the dice?

Solutions

- There are 12 possible outcomes altogether: H1, H2, H3, H4, H5, H6, T1, T2, T3, T4, T5, T6.
- The probability is $\frac{1}{12} = 0,08 = 8\%$.
- Six possible outcomes (H2; H4; H6; T2; T4; T6).
- Three possible outcomes (T2; T4; T6).
- Two possible outcomes (H5 and T5).



Worked example 4

The Moyanas are planning to have three children. A tree diagram showing all possible combinations of boys and girls in a family of three children has been drawn below.

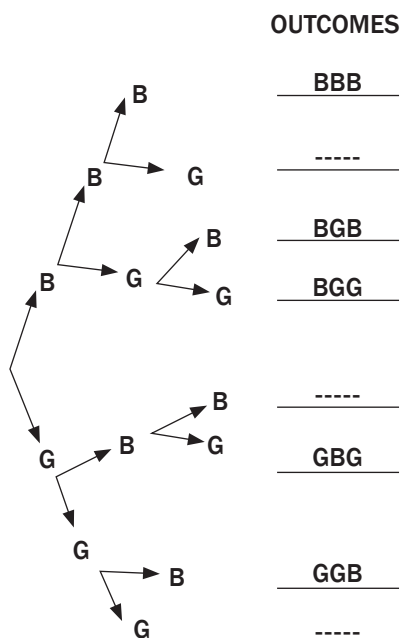

- Complete the tree diagram by filling in the missing outcomes.
- What is the probability of the Moyanas having at least two girls?
- List ALL the outcomes where she can have two boys and one girl.

Solutions

- a) Completed tree diagram:

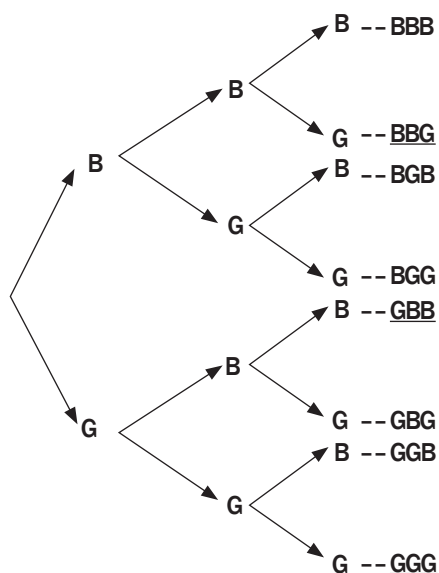

- “At least” means 2 or 3 girls. The probability is $\frac{4}{8} = 50\% = 0,5$.
- BBG, BGB and GBB.



Activity 1: Using a tree diagram

Sandwiches will be prepared for morning tea. The sandwiches are made from an equal number of white (W), brown (B) and whole-wheat (H) loaves of bread. The fillings used for the sandwiches are egg (E) or fish (F), with (M) or without (N) mayonnaise.

An incomplete tree diagram which could be used to work out the different combinations of sandwiches that could be made, is given below.

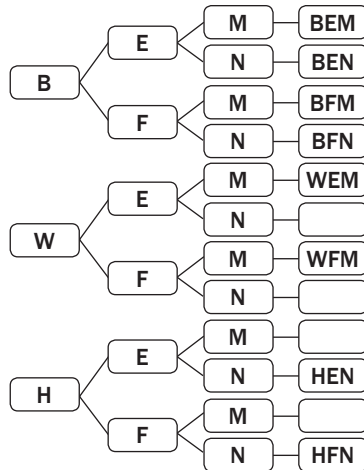

1. Explain what the outcome BEM represents on the tree diagram. (1)
 2. Complete the tree diagram. (4)
 3. Use the tree diagram to write down the probability in simplified form that a sandwich selected at random would:
 - (a) be a whole-wheat fish sandwich without mayonnaise. (2)
 - (b) not be a white bread sandwich. (2)
- [9]**

Solutions

1	BEM means brown bread with egg and mayonnaise. ✓	(1)
2	The following should be found on the tree diagram: (a) WEN ✓ (b) WFN ✓ (c) HEM ✓ (d) HFM ✓	(4)
3 (a)	$\frac{1}{12}$ OR 0,08 OR 8,33% ✓✓	(2)
3 (b)	$\frac{8}{12}$ $= \frac{2}{3}$ OR 0,67 OR 66,67% ✓✓	(3)

[9]

7.4 Using a two-way table to show combined outcomes

A two-way table (also known as a contingency table) works in a similar way to a tree diagram. We write the outcomes of one event in rows and the outcomes of the other event in columns.

For example, this table shows all the possible combinations for tossing a coin twice.

	H	T
H	H, H	H, T
T	T, H	T, T

Can you see that there are 4 possible outcomes?

Each block in the table will show a possible outcome of the combined events. Let's look at a worked example to understand this better.



Worked example 5

Pumeza collects information about the cats and dogs that learners in her class have as pets. There are 30 learners. For each learner, there are four possible responses. She collects the following information below.

- The learner has a cat and a dog: 5
- The learner has a cat but not a dog: 6
- The learner has a dog but not a cat: 12
- The learner does not have a cat or a dog: 7

Show this information in a two-way table.

Solution

	Has a dog	Does not have a dog
Has a cat	These learners have both a cat and a dog: 5	These learners have a cat but not a dog: 6
Does not have a cat	These learners have a dog but not a cat: 12	These learners do not have a cat or a dog: 7



Worked example 6

- a) Draw up a two-way table to show all the possible outcomes for tossing a red dice and a blue dice.
- b) How many possible outcomes are there?
- c) Now answer the following questions.
- (i) What is the chance of rolling a 3 on the blue dice (and any number on the red dice)?
- (ii) Write the probability of getting a 5 on the blue dice as a fraction, a decimal fraction and a percentage (round off your answers to 2 decimal places).
- d) What is the chance of rolling a 4 on the red dice and a 2 on the blue dice?
- e) What is the chance, in a single roll of both dice, of getting a 1 and a 2 of either colour?

Solutions

- a) For tossing a red dice and a blue dice we would have:

Blue/ Red	R1	R2	R3	R4	R5	R6
B1	(B1; R1)	(B1; R2)	(B1; R3)	(B1; R4)	(B1; R5)	(B1; R6)
B2	(B2; R1)	(B2; R2)	(B2; R3)	(B2; R4)	(B2; R5)	(B2; R6)
B3	(B3; R1)	(B3; R2)	(B3; R3)	(B3; R4)	(B3; R5)	(B3; R6)
B4	(B4; R1)	(B4; R2)	(B4; R3)	(B4; R4)	(B4; R5)	(B4; R6)
B5	(B5; R1)	(B5; R2)	(B5; R3)	(B5; R4)	(B5; R5)	(B5; R6)
B6	(B6; R1)	(B6; R2)	(B6; R3)	(B6; R4)	(B6; R5)	(B6; R6)

For example, (B1; R3) represents rolling a 1 on the blue dice and a 3 on the red dice.

- b) There are 36 possible outcomes.
- c) (i) The chance is $\frac{6}{36} = \frac{1}{6}$.
- (ii) The probability of getting a 5 on blue dice = $\frac{1}{6} = 0,17 = 16,67\%$
- d) There is only one block on the table for this: (B2; R4), so there is a 1 in 36 chance of this outcome.
- e) To get a 1 and a 2: could be (B1; R2) or (B2; R1), so there are two possible outcomes and hence a 2 in 36 chance. This simplifies to 1 in 18 or $\frac{1}{18}$.



Activity 2: Using a two-way table

You are putting together a gift pack for toddlers at a day-care centre. There are four possible toys, and a green, red or yellow box to pack them in. The toys are:

- coloured clay
- colouring-in book and crayons
- mini chalkboard and chalk
- pop-up story book.

1. Look at this two-way table which shows the different gift packs you have made.

	Green	Red	Yellow
A. coloured clay	10	15	5
B. colouring book and crayons	7	20	3
C. mini chalkboard and chalk	12	25	8
D. pop-up story book	9	19	5

- a) How many packs are there altogether? (6)
- b) Which pack do you have the least of? (1)
- c) Which pack do you have the most of? (1)
2. The packs are taken out of a bag randomly and given to each child. Write your answers as common fractions.
- a) What are the chances of a child getting any green pack? (2)
- b) What are the chances of a child getting any yellow pack? (2)
- c) What are the chances of a child getting a red box with a mini-chalkboard? (1)
- d) What are the chances of a child getting a green box with coloured clay? (2)

[15]

Solutions

1. You can complete the table like this to find out:







	Green	Red	Yellow	
A. coloured clay	10	15	5	30 ✓
B. colouring book and crayons	7	20	3	30 ✓
C. mini chalkboard and chalk	12	25	8	45 ✓
D. pop-up story book	9	19	5	33 ✓
Total	38	79	21	138 ✓

- a) There are 138 packs in total. ✓ (6)
- b) The yellow boxes with colouring books and crayons. ✓ (1)
- c) The red boxes with the mini-chalkboard. ✓ (1)
2. a) Use the totals from your table above. There are 38 green packs, so the probability is $\frac{38}{138} = \frac{19}{69}$. ✓✓ (2)
- b) There are 21 yellow packs, so the chances are $\frac{21}{138} = \frac{7}{46}$. ✓✓ (2)
- c) $\frac{25}{138}$ ✓
- d) $\frac{10}{138} = \frac{5}{69}$ ✓✓ (2)

[15]

7.5 Using predictions in various situations

Weather predictions

	M	T	W	T	F	S	S
Chance of rainfall	70%	80%	90%	80%	60%	20%	0%
							

Have you ever wondered what it means when the weather report says, for example, it will be partly cloudy with a 20% chance of rain?

The forecast is based on probability.

Meteorologists use special instruments to measure weather characteristics such as temperature, pressure, humidity, etc. They compare the measurements to data they already have about weather patterns. For example, they would work out that for most days with that sort of weather data, it was partly cloudy and there was rain in 20% of the cases.

Their prediction is based on data accumulated over many years.

They predict all aspects of the weather for the day, not just the probability of rainfall.



Worked example 7

- If a weather forecast says there is an 80% chance that it will rain in your area, does that mean that you will definitely see rain? Is there a chance that it will not rain where you are? Explain.
- How can weather forecasters improve the accuracy of their predictions? Write down two ways.

Solutions

- Forecasters know that it rained on 80% of the days in the past with similar weather conditions, but they can only state a probability, not exactly what will happen. There is also a 20% probability of no rain.
- If there is more data collected over a longer period of time, the prediction will be more reliable.

Improved methods of measuring the weather characteristics will also give more reliable data.

They can also improve the methods for analysing the data. As computers become more powerful and more specialised, they can improve their methods of analysis.

7.6 False positives and false negatives

Tests such as medical screening tests, pregnancy tests, drug tests and blood alcohol tests are very accurate, but there is always a small probability that the results are wrong. Sometimes there are underlying reasons for the test to be wrong. It is wise to do a test more than once, to increase the probability of a correct result.

When you have a test that can say 'Yes' or 'No' (such as a medical test), you have to think:

- It could be wrong when the result is 'Yes'.
- It could be wrong when the result is 'No'.

Wrong results are called False positives and False negatives. This table shows the four possible situations:

	The result is Yes	The result is No
The real situation is yes	The test is correct	False negative
The real situation is no	False positive	The test is correct

(Remember that an incorrect result is usually very unlikely.)



Worked example 8

A laboratory tests people for a virus, using a screening test. This is a quick test that works in about 5 minutes.

There is a 0,4% chance that this test will produce a false positive. This means that 99,6% of the time a positive result will indicate a true positive result. The test is therefore 99,6% accurate.

So if a person gets a positive result, a second test must be done to determine if the person does really have the virus.

- a) (i) Give the possibility of a false positive as a fraction with a denominator of 1 000.
 (ii) If 3 000 people who don't have the virus are tested, and 0,4% of them test positive, how many people will this be?
- b) A person who tests positive on the quick test is given a second test. This test takes longer to do, is more expensive and must be done in a laboratory. It has the following accuracy rate, given a sample of 1 000 000 people:

	Test positive	Test negative	Total
Carry the virus	4 885	115	5 000
Do not carry the virus	2 630	932 370	995 000
Total	12 515	932 485	1 000 000

(From: Edith Seier and Karl H. Joplin *Introduction to statistics in a biological context*)

- c) What is the probability of a person who does not have the virus testing positive in the second test? Write this as a percentage, to one decimal place.
- d) Give a possible reason for why people are not tested using the laboratory test the first time.

Now I understand that probability is the best guess we have with the information we have.



Solutions

- a) (i) $\frac{0,4}{100} = 4$ out of 1 000 = $\frac{4}{1\ 000}$
 (ii) $\frac{4}{1\ 000} \times 3 = 12$ out of 3 000 people.
- b) If the person does not have the virus, they fall into the category "Do not carry the virus".
 A total of 995 000 people were tested who did not carry the virus.
 Of these people, 2 630 tested positive.
- c) The probability is $\frac{2\ 630}{995\ 000} = 0,0026 \approx 0,3\%$.
- d) The laboratory test is more expensive and it takes longer to do. So it is only used to confirm positive results.



Activity 3: False positives and false negatives

When an athlete takes a drug test, two samples are taken. If the first sample (A) tests positive for drugs, but the athlete believes the test is giving a false positive, they can choose whether to have the second sample (B) screened as well.

Read the extracts from newspaper articles and then answer the questions that follow.

Nothing is 100% certain! But if people analyse enough data, they can get really good at predictions.



Extract 1:

Comrades winner fails B-sample drug test

13-JUL-2012 | SAPA | 52 Comrades Marathon winner Ludwick Mamabolo is in danger of losing his title after his B-sample tested positive for methylhexanamine, the SA Institute for Drug Free Sport (SaiDs) says.

Mamabolo would face a hearing on a doping charge, according to SaiDs

Mamabolo's A-sample tested positive for the banned stimulant after he won the annual 89 km ultra-marathon in Durban last month.

Extract 2:

Comrades winner relieved

2013-05-01 12:20 m.news24.com

Johannesburg - Comrades Marathon champion Ludwick Mamabolo says he is relieved after being cleared of doping charges, more than 10 months after winning the annual ultra-marathon in KwaZulu-Natal.

'I am delighted that I now have my good name and livelihood back,' Mamabolo said on Wednesday. I rely on running to support my family.'

Mamabolo tested positive for methylhexanamine last season, shortly after he became the first South African in seven years to win the Comrades Marathon. His B-sample confirmed the presence of the banned stimulant.

Werksmans Attorneys, which handled Mamabolo's case, said as many as 15 irregularities were found in the testing process, so Mamabolo was found not guilty.

'We are certain this is the right result for him and for sport,' said Werksmans Attorneys.

Extract 3:**Marathon Association in bid to improve testing procedures**

Wednesday 29 May 2013 14:52, SABC

The Comrades Marathon Association has improved its drug testing procedures to ensure accurate testing for this year's race.

This comes after last year's winner, Ludwick Mamabolo, had tested positive for illegal drugs but was later found not guilty after a panel of experts found that the testing process was not up to scratch.

1. If the drug test has a 95% accuracy, what is the probability that there is a false positive? (1)
 2. Imagine that the test has a 95% accuracy. If the first test gives a false positive, what do you think are the chances that the second test (B sample) is also wrong? Choose from:
 - (a) certain
 - (b) unlikely
 - (c) very unlikely (3)
 Explain your answer in full.
 3. Can we be 100% certain that Mamabola did not take a stimulant? Explain. (1)
- [5]**

Solutions

1. The probability of the test being wrong is 5% or 0,05. ✓ (1)
 2. The answer is (c) very unlikely ✓. The test is unlikely to get an incorrect result once, ✓ so it is much less likely that it would be wrong twice. ✓ (3)
 3. We cannot be absolutely certain, as there does exist a very small ✓ possibility that the second test is also incorrect (a false negative). (1)
- [5]**



Activity 4: Mixed questions about probability

1. Read the news article extract carefully and answer the questions that follow.

“Lightning kills hundreds every year in South Africa”

More than 260 people are killed by lightning in South Africa each year, the SA Weather Service (SAWS) said on Wednesday. This figure is an annual average based on Statistics SA data between 1999 and 2007, when 2 375 lightning related deaths were reported.

The Weather Service said it was likely that some deaths went unreported.

‘The year with the lowest recorded death rate was 2 000, when only about 205 [deaths] were reported.’

Most of the lightning fatalities happened in the Eastern Cape, closely followed by KwaZulu-Natal.

Provinces with the second-highest risk were the Free State, Gauteng, and North West.

Mpumalanga and Limpopo had slightly lower lightning risks, while the Northern and Western Cape had low incidences of lightning.

(Source: Timeslive.co.za, 20 February 2013)

1. Where did the SA Weather Service obtain the data for their report that more than 260 people are killed by lightning each year? (1)
2. Explain how SAWS obtained the figure of 260 for the number of deaths per year. Show the calculation. (3)
3. What kind of statistic is SAWS using when it reports this number? (1)
4. SAWS says that it is likely that the number of deaths due to lightning is under-reported. Calculate what the mean would be if the actual number of deaths from 1999 to 2007 was 3 000. (2)
5. Were the deaths equally spread out among the nine provinces? Explain. (3)
6. Which information did SAWS use in order to arrange the provinces in order of risk? (2)
7. Consider these two scenarios of lightning related deaths:
 - **Scenario A:** 100 deaths in one year in a province with a population of 10 000 000
 - **Scenario B:** 20 deaths in one year in a province with a population of 1 000 000

Which of the scenarios indicates a higher probability of death due to lightning? Show your working. (5)
8. Some relevant information is not given in this report. Explain. (4)

[21]

Solutions

1. The data was obtained from Statistics South Africa. ✓ (1)
2. They took the total number of deaths for all the years, which was 2 375, ✓ and divided it by the number of years between 1999 and 2007.
 $2\,375 \div 9 = 263,8$ deaths. ✓✓ (3)
3. The mean. ✓ (1)
4. $\text{mean} = 3\,000 \div 9 = 333,33$ ✓✓ (2)
5. No, some provinces have a higher risk than others. ✓ The risk is highest in the Eastern Cape and KwaZulu-Natal. ✓✓ (3)
6. The article states 'Most of the lightning fatalities happened in the Eastern Cape'. This indicates that they used the number of lightning fatalities per province to indicate the risk. ✓✓ (2)
7. Scenario A: Probability = $100 \div 10\,000\,000$ ✓ = 0,00001 or $\frac{1}{100\,000}$ ✓
Scenario B: Probability = $20 \div 1\,000\,000$ ✓ = $\frac{2}{100\,000} = \frac{1}{50\,000}$ ✓
Scenario B has a much higher risk. ✓ (5)
8. The report does not state whether the risk numbers ✓ per province were adjusted for the population of the province. ✓ It simply states that the 'most fatalities' ✓ occurred in the Eastern Cape. This is also a province with one of the highest populations. ✓ (4)

[21]



Activity 5: Mixed questions about probability

1. Look at the lightning risk map below and read the extract that follows.

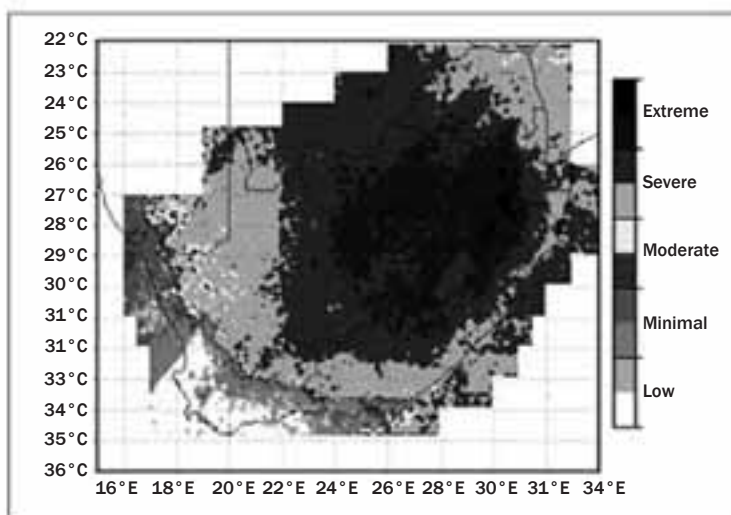

Before 2006, the SAWS (South African Weather Service) was unable to measure lightning activity over South Africa. This limited the SAWS in both its service delivery and public good. This inability changed with the installation of a lightning detection network (SALDN), which enabled the SAWS to explore lightning activity for the first time. These data provide South Africa with the first lightning climatology, based on data for more than a year, measured by the new state-of-the-art SALDN.

Analysis of the maps shows that the highest concentrations of lightning are found over the central to northern interior of the country, with extreme risk areas along the northern escarpment extending from the northern parts of KwaZulu-Natal into the Mpumalanga Lowveld. Almost the entire country is at severe risk from lightning in general. Only towards the west of the country does the concentration of lightning, as well as the lightning risk, decrease.

(Adapted from: <http://www.scielo.org.za>)

1.
 - a) Compare the sources and types of data in question 1 and the article above. (2)
 - b) Give two reasons why the data in this extract indicates different risks than the article in question 1. (8)
 - c) Which of the articles gives the best estimate of the risks? Explain your opinion. (2)

[12]



The answer must show your awareness of how risks are assessed using probability, as well as the type of data that is reported in the articles.

Solutions

1. a) Article 1: The data was the number of reported lightning related deaths over nine years, and the source of the data was Statistics South Africa. ✓
 Article 2: The data was the lightning density over the country. The source was the SA lightning detection network, which measured the lightning. ✓ (2)
- b) The data set in the second article is the measured lightning density figures, ✓ using the new LDN. The risks are measured according to the lightning density, ✓ rather than reported deaths. This is apparently a scientific and more accurate method. ✓
 The data in the first article was measured up to 2007. The second article uses more up-to-date data. ✓
 The risk of lightning-related death is not best given by the number of deaths per province, ✓ because this depends on the number of people in the area, ✓ as well as the fact that not all of the data had been reported accurately. ✓
 Also note that the first article did not explain whether population figures had been taken into account. ✓ (8)
- c) You need to support your opinion with facts in this question. ✓
 The lightning detection network has only been active since 2006. ✓ (2)

[12]





The Mind the Gap study guide series assists you to make the leap by studying hard to achieve success in the Grade 12 exam.

This publication is not for sale.

© Copyright Department of Basic Education www.education.gov.za

This publication has a Creative Commons Attribution NonCommercial Sharealike license.

Call Centre 0800 202 933



basic education

Department:
Basic Education
REPUBLIC OF SOUTH AFRICA